

# ORBIS PICTUS LATINUS

Hermann Koller

Vocabularius imaginibus illustratus

Lateinisches Bildlexikon

Dictionnaire latin illustré

Illustrated Latin Dictionary

Dizionario latino illustrato

Diccionario latín ilustrado

Artemis Verlag



Quid hic libellus velit, iis, quae Iohannes Amos Comenius Orbi Sensualium Picto suo praemiserat, optime declaratur: „Sensus ... obiecta sua semper quaerunt, absentibus illis hebescunt, taedioque sui huc illuc se vertunt; praesentibus autem obiectis suis hilarescunt, vivescunt, et se illis affigi, donec res satis perspecta sit, libenter patiuntur. Libellus ergo hic ingeniis ... captivandis et ad altiora studia praeparandis bonam navabit operam.“

Nimum saepe notiones sermone Latino expressae non re vera perspiciuntur quia desunt cogitationes repraesentationesque rerum in animis lectorum saepiusque earum in loco auditur merus strepitus vocum nihil significantium. Huic infirmitati docendi mederi studebat Comenius primo vocabulario Latino imaginibus illustrato, quem posteriores multi imitati sunt – ad illustrandos sermones vernaculos! Lingua Latina autem adhuc caret vocabulario imaginibus illustrante res et conceptus peculiare Latinos, inter quos etiam adnumeranda sunt omnia, quae in Latinitate mediaevali hodiernaque accesserunt, nec non Graeca sub forma Latina in usum cottidianum introducta. Conatus sum illustrare notiones in litteris Latinis saepius occurrentes, ea autem intentione, ut res Romanae documentis Romanis demonstrarentur. Ad hanc rem perpetranda maximo usui mihi fuerunt A. Rich et Daremberg-Saglio, qui hodie perpaucis prae manu sunt. Eorum delineamentis saepe usus sum in conscribendo hoc libello. Definitiones autem verborum plerumque Forcellinio Thesauroque Linguae Latinae adiuvantibus confeci ita, ut breviores et ad captum discipulorum lectorumque inexpertorum aptiores fierent.

Insunt aliquot imagines, quae non ab omnibus rerum antiquarum peritis eodem modo explicabuntur. Cura mihi fuit in componendo hoc opusculo didactico, ut imagines vocabula in auctoribus inventa ante oculos ponerent, non ut in rebus dubiis iudicis mihi partes vindicarem. omnibus hoc libello comprehensis aut in schola cum discipulis aut in colloquiis Latinis Universitatis studiorum Turicensis cum studiosis aliquot annos usus sum ad legendos et interpretandos auctores Latinos. Latina autem Latine tractanda esse iamdudum mihi, monente Erasmo, persuasum est.

Lemmata huius opusculi non comprehendunt omnia, quae in legendis antiquorum scriptis explicatione egent. Multa desiderabuntur, quia nonnumquam imagines bene distincteque delineatas invenire non potui. Adiunxi proprio Marte aliquot mediaevalia et hodierna ut omnia se vicissim explicarent in libro et ut nexus idearum conceptuumque inter tempora antiqua et hodierna dilucidior fieret. Eodem spectant exempla e Margarita Philosophica, Historia de Gentibus Septentrionalibus, Orbe Sensualium Picto aliisque sumpta, quae demonstrabunt sermonem Latinum plus quam duo milia annorum viguisse semperque in flore esse.

Spero fore, ut hoc opusculum non inter semel legendos, ut ait Plinius, sed saepissime lectitandos libros collocetur. Sit venia primum experienti!

Turici, mense Septembri MCMLXXVI

## Praefatio ad tertiam editionem auctiorem

A discipulis, studiosis Universitatis, multisque lectoribus adiutus incitatusque ad novas imagines investigandas editionem hanc tertiam Orbis Picti Latini multo auctiorem reddidi. Ideo aucta est editio nova circiter quarta parte, ita ut nunc numerus imaginum 1000 excedat. Vocabula his imaginibus illustrata duo milia superant. Nova non modo adiuncta sed inter reliquos articulos recto ordine alphabetico inserta sunt litterisque cursivis scripta vel lineis subnotata cum omnibus adhuc exstantibus colligantur. Praecipua pars imaginum refertur ad res nobis in litteris Latinis antiquioribus occurrentes, recentissima autem et hodierna in P. Caelestis Eichenseer libello, cui inscriptio est „Latinitas Viva“, inveniuntur. Multa consilia in opere meo perficiendo huic fautori Latinitatis vivae gratissimus debeo.

Inter additamenta nova memoranda sunt „cos“, „salus“, „dies“, „acta diurna“. His multisque aliis rebus additis Orbis Pictus Latinus multo utilior fiet et iterum, spero, ut in primis duabus editionibus, „in toto orbe legetur“.

Omnia per compendium perscripta notis infra adductis explicantur.

Turici, mense Aprili anni MCMLXXXIII

Hermann Koller

### notae

a. Ch. n. ante Christum natum	h. e. hoc est	praef. praefatio
adi. adiectivum	hisp. Hispanice	proverb. proverbium
cf. confer	i. e. id est	reconstr. reconstructum
coll. collectio	it. Italiane	s. sequens, ss. sequentes
etc. et cetera	m. masculinum	sc. scilicet
ex. gr. exempli gratia	n. neutrum	sg. singularis
f. femininum	p. Ch. n. post Christum natum	subst. substantivum
fr. Francogallice	ptc. participium	v. gr. verbi gratia
gr. Graece	pl. pluralis	

### signa

- \* = uno asterisco notantur verba Latinitatis christianae,
- \*\* = duobus asteriscis verba mediaevalia,
- \*\*\* = tribus asteriscis verba hodierna.

*litteris cursivis* impressa sunt verba in proprio lemme occurrentia.

### linea subnotata sunt

- a) verba, quae non lemma faciunt sed in textu explicantur, inveniuntur etiam in indice generali.
- b) nomina auctorum qui citantur.

quantitates syllabarum interdum designantur (ˉ = syllaba longa, ˘ = syllaba brevis) ut expeditius legi possit textus.

## abacus —i, m.

- a) abacus est tabula calculatoria, qua utebantur arithmetici et geometrae.  
b) abacus est tabula lusoria.

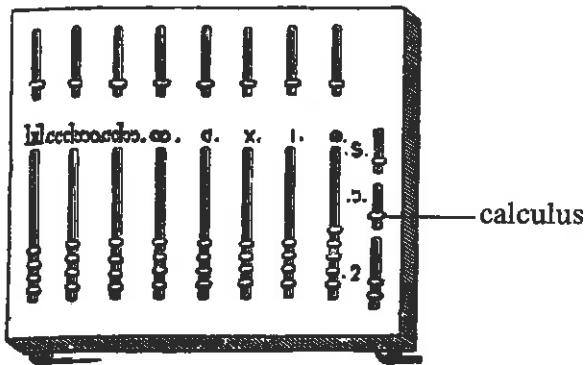

- c) abacus erat etiam mensa vel tabula multis areis (*area*) iisque excavatis distincta, in quibus urceoli immittebantur et exponebantur oleo aut vino referti. saepe abaci exquisitā elegantia, facti, aerati ornatique sunt, in iisque exponebantur vasa aurea, argentea pretiosaque.



- d) abaci dictae sunt etiam crustae, tabulaeve quadratae e marmore, vitro aut simili materia, quae multicolorae et imagines aliquas repraesentantes parietum ornamenta erant, iis tectorii (*tectorium*) vice insertae.

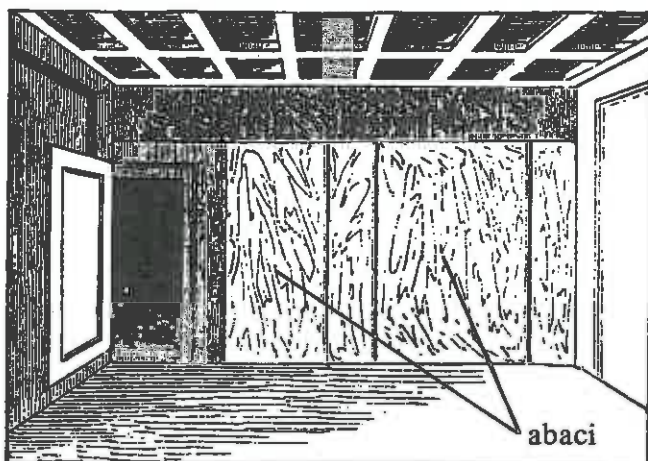

- e) abacus in architectura est quadrata planities in summis columnarum capitulis (*columna, capitulum*).

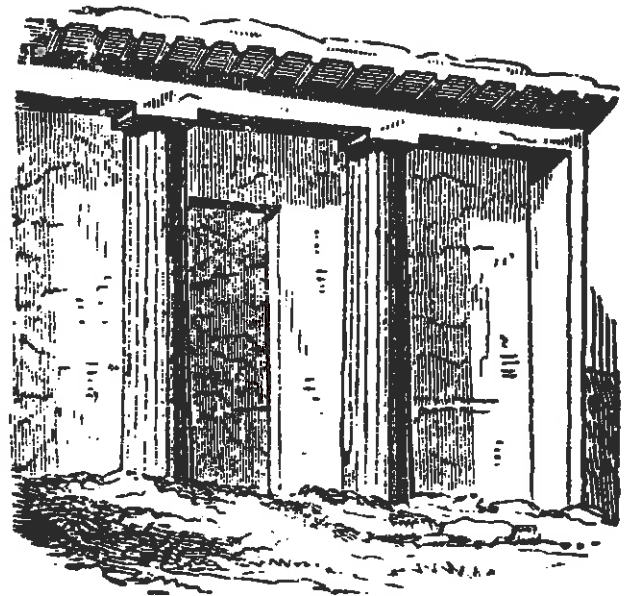

## acanthus —i, m.

acanthus est nomen commune cuiusque plantae spinosae, peculiariter est herba folio quam lactucae latiore multo et longiore, erucae modo incisuris divisa et laciniosa, in hortis nascens et locis humentibus (*Acanthus spinosus* L.). foliis acanthi *capitulum* Corinthium formatur: vide duo exempla in imaginibus.



folia acanthi

## acetabulum –i, n.

acetabulum est vas, in quo acetum ponitur.  
acetum (sc. vinum) = vinum acidum, quo olera  
et alia edulia condiuntur.

Plautus, Rud. 937 s.:

„cum acetopransurus est  
et sale“.

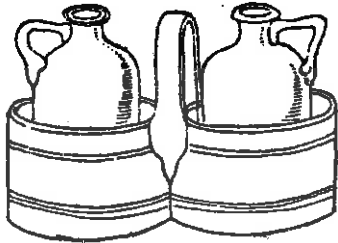

## acies –iei, f.

a) est pars acuta ferri aut alterius rei, qua secatur  
aut pungitur. acies cotis opere excitatur. (*cos,*  
*acus*).

b) acies est maxima videndi vis vel actio. trans-  
late etiam de acie animi dicitur.

c) in re militari acies ponitur pro parte exercitū  
instructā et dicitur de integro exercitu exstructo  
et ad proelium parato.

## aconitum –i, n.

herba venenata foliis cyclaminis aut cucumeris,  
non pluribus quattuor, ab radice leniter hirsuta:  
aconitum etiam ponitur de quocumque veneno:

Ovidius, Met. 1, 147:

„lurida terribiles miscent aconīta novercae.“

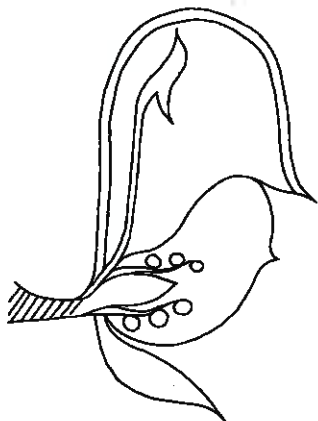

flos aconīti

## acroterium –i, n.

significat summitatem, extremitatem, verticem  
(*vertex*) cuiuscumque rei.

acroteria sunt parvae statuetae seu sigilla, quae



acroterium in fastigio templi Aeginae



acroteria  
in templis  
Romanis

fastigiis (*fastigium*) templorum domuumque imponuntur, v. g. capita leonina aut humana, item integrae imagunculae, et alia huiusmodi ornatūs gratiā.

## acta diurna

acta diurna primum a C. Iulio Caesare in foro Romano publicata sunt. commentarii erant diurni rerum cottidie gestarum. scripta erant in albo (*album*), ita ut transeuntes legere possent, ut hodie in aliquot terris \*\*\*acta diurna parietalia quae dicuntur. hodie acta diurna typis imprimuntur vel computatoriā machinā, qui acta diurna scribunt, \*\*\*diurnarii scriptores nominantur. veneunt acta diurna a \*\*\*diurnorum vel diariorum venditoribus. ephemerides vel hebdomadales vel mensuales sunt vel quater anno distribuuntur. acta diurna vel urbana a scribis multis exemplaribus divulgabantur et magistratibus, qui ab Urbe aberant, mittebantur. Cicero, ad Att. 6, 2, 6: „Habebam acta urbana usque ad Nonas Martias; e quibus intellegebam Curionis nostri constantia omnia potius actum iri quam de provinciis.“

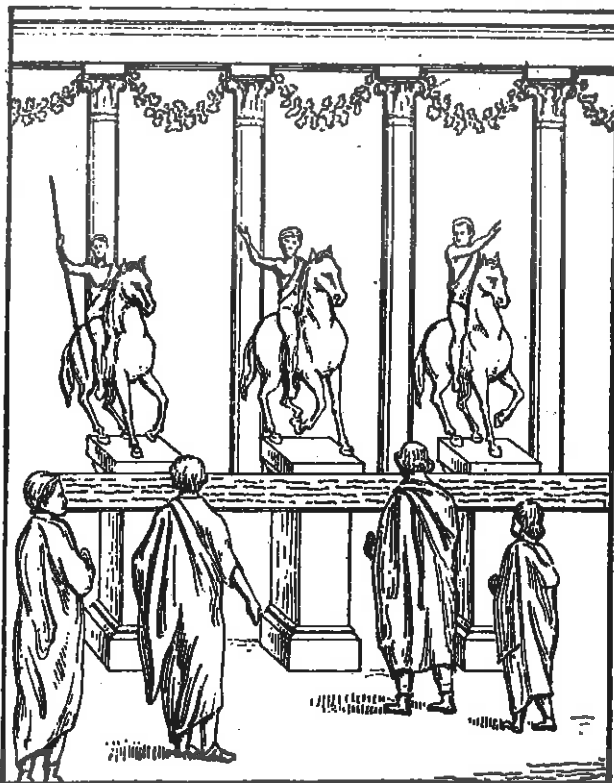

Romani in foro acta diurna legentes  
(in picturā murali Pompeianā)

## acus -ūs, f. aut m.

acus est minimum acutissimumque instrumentum, quod constat ex ferro aliove metallo aut

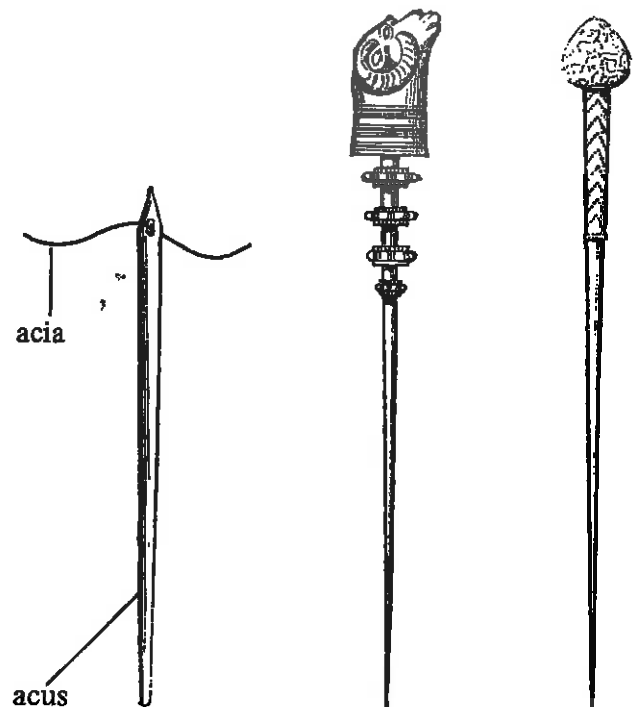

etiam ex eburno, et pluribus inservit usibus, ex. gr. vestibis consuendis aut ornandis. formula: immittere lina per acum. proverbium: acū rem tangere = est rem divinare. verbum: acuo, -ui, -utum, -ere = aciem ferri excitare, trahere, et proprie ponitur de falce, cultro (*culter*) etc. cui contrarium est „obtundere“.

acia -ae, f.

est filum in acu ad suendum.

proverbium:

„ab aciā et acū omnia exponere“, quod significat vel minutissimas res narrando exponere, totamque alicuius facti seriem alte ductis initiis diligenter nihilque prorsus omittendo explicare.

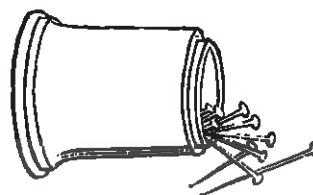

capsa acuum

**adorans** –antis, m. f., vel orans, –antis, m. f.

adorare = aliquem aliquid rogare alloquendo,  
deos adorare = deos precari.

**gestūs adorandi:**

habitus autem adorantium erat, ut dexteram  
ad os referrent et totum corpus **dextrorsum**  
circumagerent, aut ambas manūs palmis (**palma**)  
apertis ad caelum tollerent.



adorans, vel orans, e  
Callixti catacumbis,  
Romae

**aedicula** –ae, f.

est parva aedium pars, cella, cubiculum. ponitur  
etiam pro parva aede sacra, sacello.



aedicula portatilis

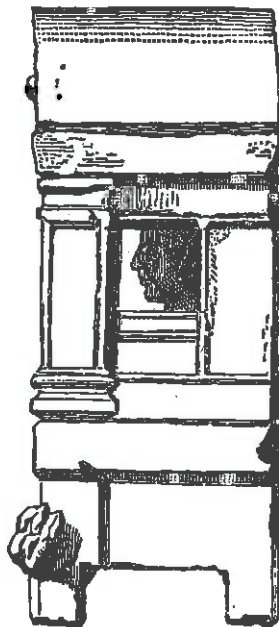

**Petronius, Sat. 29 in fine:**

„grande armarium in angulo vidi, in cuius aedi-  
cula erant **Lares** argentei positi Venerisque  
signum marmoreum.“

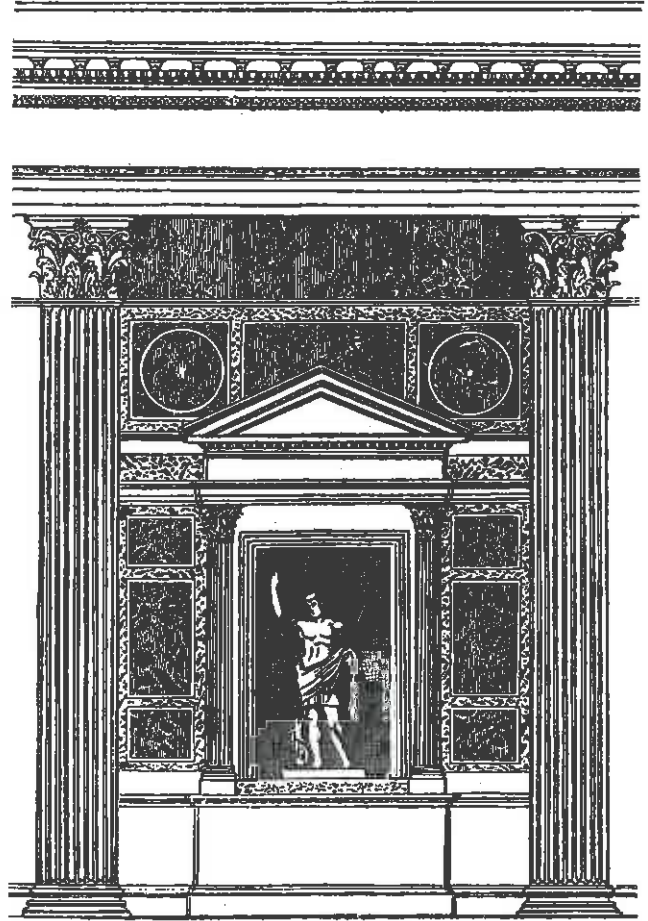

aedicula in Pantheone Romano (*Pantheon*)

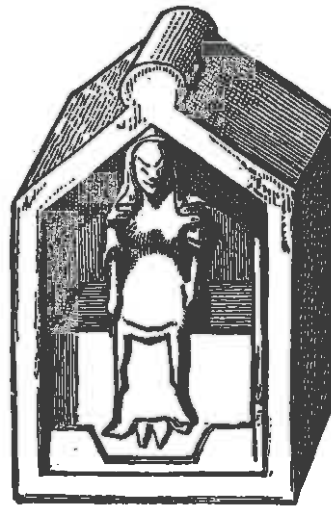

aedicula portatilis



## aedituus –i, m.

aedituus (vel aeditumus) est sacrae aedis custos.  
Plautus, Curc. 203/04:  
„... sonitum et crepitum claustrorum audio,  
aedituum aperire fanum ...“



## aegis –idis, f. (acc. Graec. –ida)

a) est pellis caprae.  
b) aegis est munimentum pectoris aeneum,  
habens in medio Gorgonis caput.  
Ovidius, Met. 6, 79:  
„defenditur aegide pectus.“  
c) ceterum aegis est scutum, quod ab antiquis  
Iovi et Palladi tantum tribuitur.  
Vergilius, Aen. 8, 354/55:  
„credunt se vidisse Iovem, cum saepe nigrantem  
aegida concuteret dextrā nimbosque cieret.“



aegis Palladis



aegis = lorica

## aequitas –tatis, f.

a) dicitur de planā rerum superficie (*superficies*)  
b) est aequa partium *proportio*  
c) ponitur et de civium in rē publicā aequalitate.  
Cicero, de re publ. 34, 53:  
„cum enim par habetur honos summis et infimis,  
qui sint in omni populo necesse est, ipsa aequitas  
iniquissima fit.“



## Aesculapius –i, m.

est deus medicinae artis auctor et medicinarum  
inventor. eius *symbolum* est baculum cui  
serpens inhaeret.



## aetates hominis

hoc modo Amos Comenius in opere, cui titulus est Orbis Sensualium Pictus septem aetates

hominis gradibus ascendentibus et descendentibus scalae repraesentat:

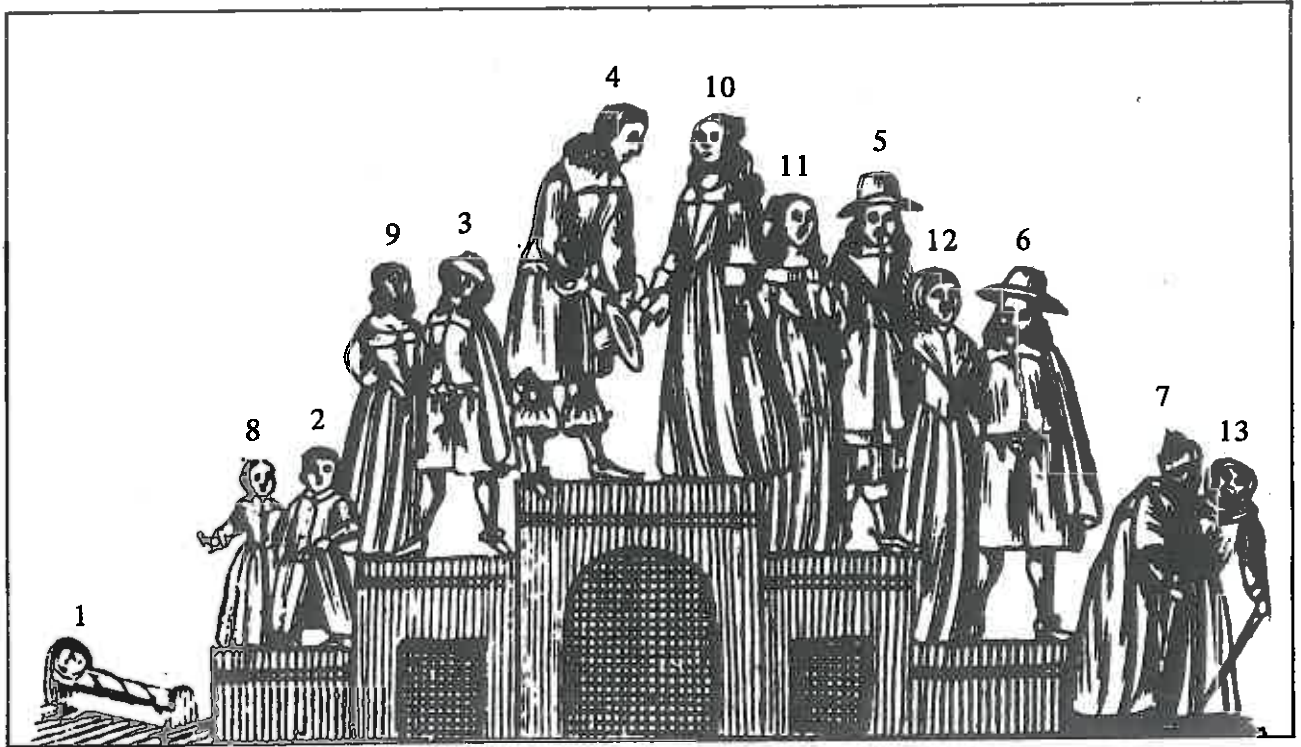

1 infans

2 puer

3 adolescens

4 iuuenis

5 vir

6 senex

7 silicernium

sic etiam in altero sexu:

8 pupa

9 puella

10 virgo

11 mulier

12 vetula

13 anus decrepita

## affinitas —atis, f.

a) affinis est is, qui mihi vicinus est, cuius agri finem communem habent cum meis.

b) affines sunt, qui per nuptias copulantur. (*cognatio*) gradus affinitatis sunt:

socer / socrus (—ūs, f.)  
(pater / mater mariti)

socer / socrus (—ūs, f.)  
(pater / mater uxoris)

levir  
(frater mariti)

glos  
(soror mariti)

maritus

uxor

nurus (—ūs, f.) — filius  
(uxor filii)

filia — gener  
(maritus filiae)

noverca est uxor, quam vir post mortem primae uxoris in matrimonium ducit.  
vitricus est maritus, cui femina post mortem

primi mariti nubet.  
privignus est filius primi matrimonii,  
privigna est filia primi matrimonii.

**agitator** –oris, m.

agitator proprie est qui agit; sed speciatim est qui equos aut alia iumenta agit, auriga.

Cicero, Acad. 2, 94:

„ego, ut agitator callidus, priusquam ad finem veniam, equos sustinebo.“

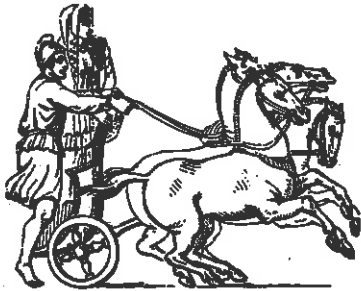

agitator equorum



auriga

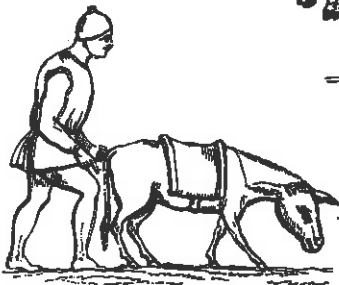

agitator aselli

**album** –i, n.

a) erat tabula dealbata gypso illito, in qua nonnulla perscribebantur et proponebantur in publico, ut ab omnibus legi possent.

Livius, 9, 46 de Cn. Flavio:

„civile ius ... evulgavit fastosque circa forum in albo proposuit, ut, quando lege agi posset, sciretur.“

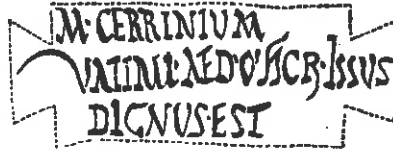

b) tabula, in qua perscribebantur praetorum edicta, actiones, interdicta, actionum formulae, item litigatorum nomina actionesque, et alia huiusmodi ad forum civilesque contentiones spectantia.

c) album significabat etiam nominum indicem (*index*), in quem omnes alicuius classis homines referebantur: album senatorum, etc.

**allocutio** –onis, f.

allocutio = nomen verbale verbi „ad-loquor“. allocutio est oratio, qua imperator milites ad pugnam hortatur.



allocutio imperatoris Romani in opere caelato.

1 imperator 2 lictores 3 signiferi 4 signa 5 vexillum 6 suggestum

## alticinctus —i, m. (adi. —us, —a, —um)

est alte cinctas vestes habens; dicitur de homine negotioso, qui alte cingit *vestimentum*, ut in opere expeditior sit.



## alvearium —i, n.

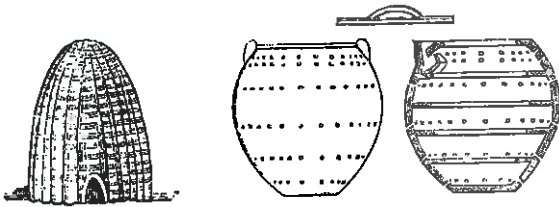

- a) est vas in alvei modum cavatum.  
b) speciatim occurrit pro vase, in quo apes nidi-  
ficant et mellificant.  
Vergilius, *Georg.* 4, 33 ss.:  
„ipsa autem seu corticibus tibi suta cavatis  
seu lento fuerint alvearia vimine texta,  
angustos habeant aditus ...“  
Columella, *R. R.* 9, 5, 3:  
„ubicumque fuerint alvearia, non editissimo  
claudantur muro.“  
c) latiore sensu ponitur pro loco, in quo sunt  
alvearia, quod et apiarium dicitur.

## alveus —i, m.

- a) est cavitas, ex. gr. fossa per quam fluuius de-  
fluit.  
b) in balneis est fossa cavata ex lapide habens  
intus suos gradus ad descendendum.

- c) fundi navium alvei dicuntur.  
d) alveus dicitur de quocumque vase concavo,  
ex. gr. alveus *pistoris*, in quo massa tractatur.

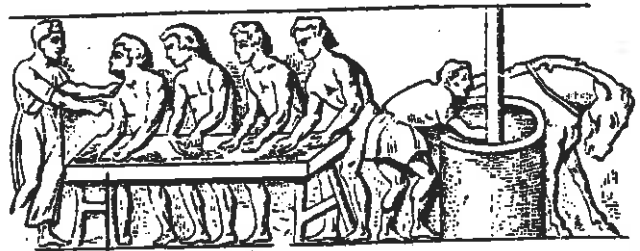

alveus pistoris

## \*ambo —onis, m.

ambo est apud ecclesiasticos scriptores suggestus  
seu pulpitum, in quo stant contionaturi. in basi-  
licis (*basilica*) christianis duo ambones erant, in  
sinistro epistula legebatur, in dextro evangelium.  
Cassiodorus, *Hist. Eccl.* 10, 4:  
„episcopus residens super ambonem, ubi solebat  
consuecte facere sermonem.“

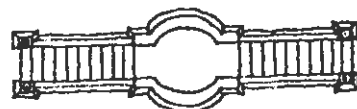
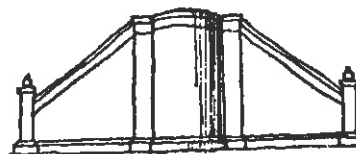
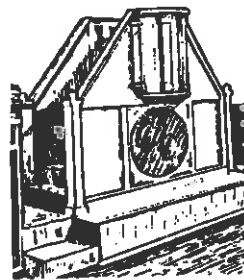

## amphitheatrum —i, n.

est aedificium circulari seu potius ovali formā, in usum spectaculorum exstructum. in eo erant gradūs circum undique, et sedilia disposita ad spectandum, in medio spatium, quod arena dicebatur, quia arenā spargi solebat, ut ludentes

commodius insisterent. praecipua certamina erant gladiatoria, venationes et damnatorum pugnae cum feris, *naumachiae* etc. non solum Romae, sed in omnibus oppidis provinciarum ubi milites stativa habebant, amphitheatra aedificata sunt.

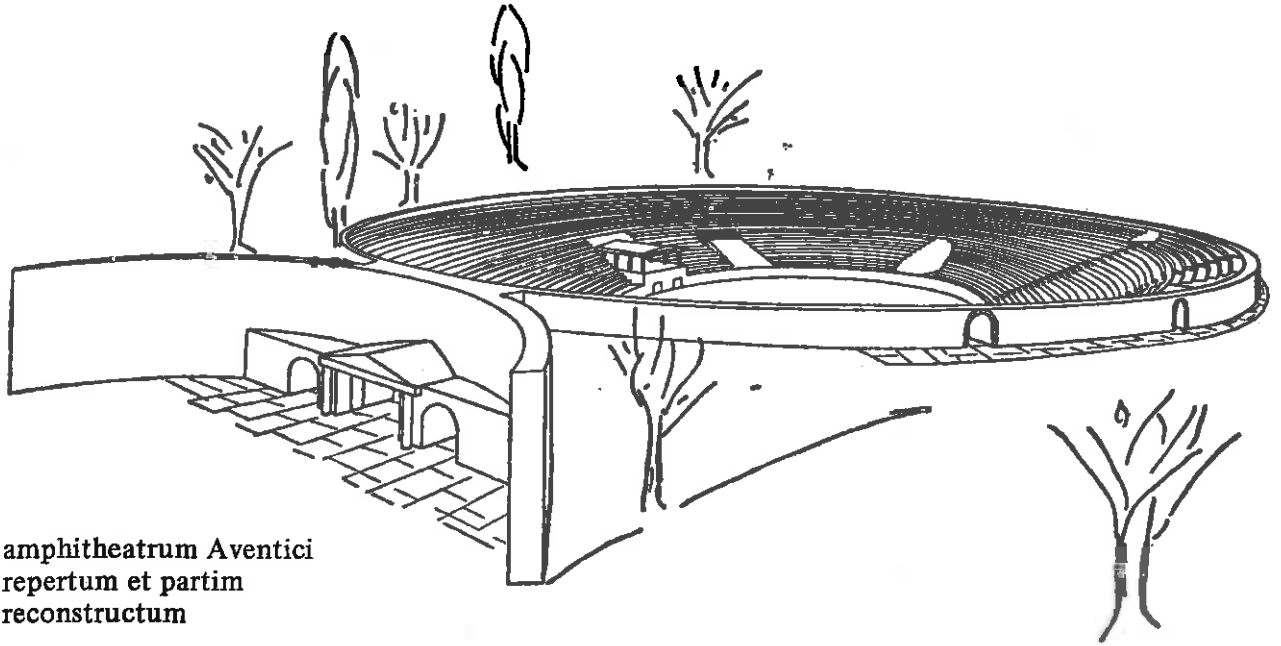

amphitheatrum Aventici  
reperitum et partim  
reconstructum

## amphora —ae, f.

est genus vasis, plerumque fictilis. habebat utrimque ansas (*ansa*). inserviebat praecipue ad liquores (oleum, vinum) condensos. amphorae in inferiore parte erant acutae, ut in abaco aut in harenā poni possent.

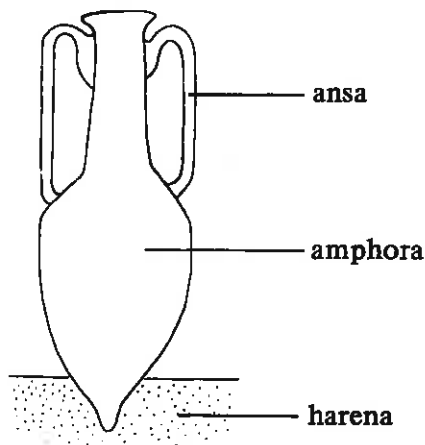

## ampulla —ae, f.

est vasis genus ex vitro aut alia materia, turgidum velut inflato ventre, et angusto ore, quo oleum veteres in balneis (*balneum*) servabant; item quo in mensa ad acetum continendum, aliquando etiam ad bibendum utebantur.

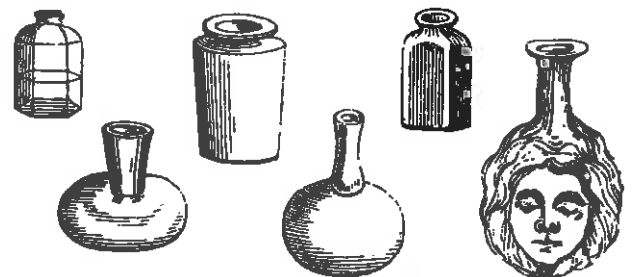

ampullae

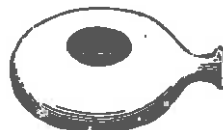

ampulla olearia

**ancora** –ae, f.

est ferreum instrumentum duobus instructum veluti brachiis (**bracchium**) aduncis, quod alligatum fune (**funis**) in mare iacitur et fundo adhaerens naves detinet.

translate: ancoras tollere significat abire, discedere.

\*\*ancora *symbolum* erat quo Christus significabatur.

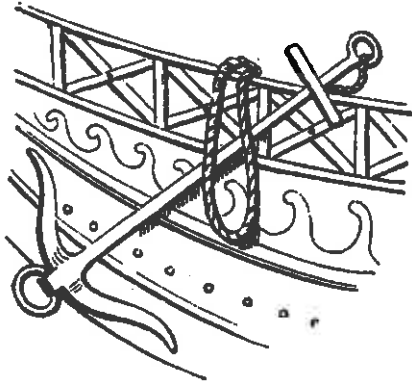

**Anglia sive Britannia Romana**

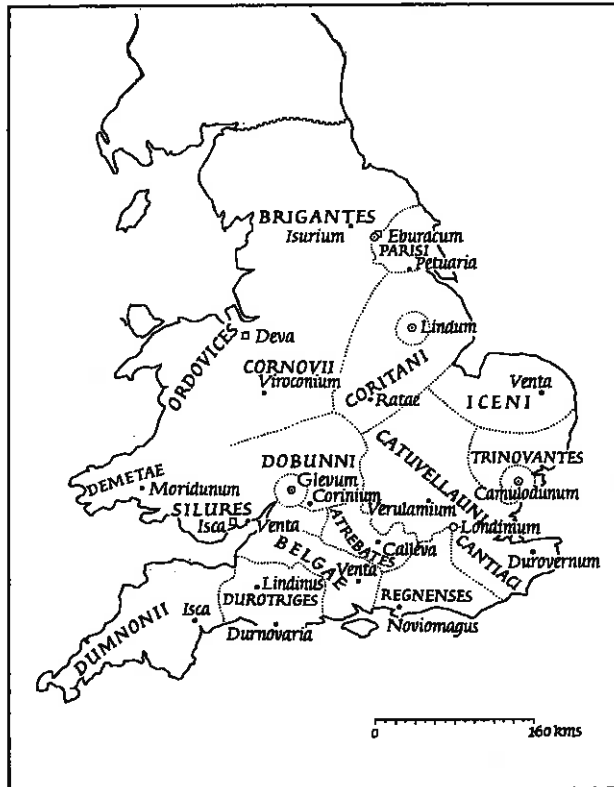

**GENTES**

- coloniae
- oppida
- ◻ castra legionis

**annona** –ae, f.

a) annona accipitur pro annuo terrae, bovm aliarumque rerum fructū vel reditū ad victum necessario.

b) pro ipso pretio rerum, quae ad victum sunt necessariae.



in nummo Annona cum *cornu copiae* ante Cererem in solio (*solium*) sedentem stat, a qua *spicas* accipit

**annus** –i, m.

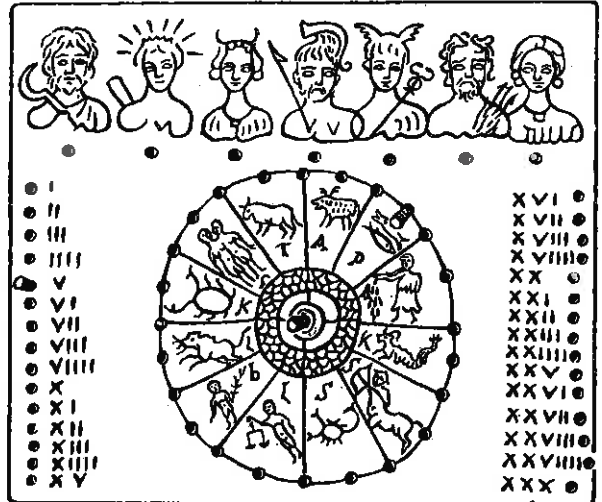

annus est tempus, quo sol per zodiacum (*zodiacus*) cursum suum conficit, scilicet spatium 12 mensium, seu 365 dierum et 6 horarum minus 12 minutis.

in hoc calendario (*calendarium*) lapideo exeuntis aetatis Caesarum annus repraesentatur circulo zodiaci, menses duodecim eius signis, dies mensis triginta numeris Romanis. septem dei planetarum hebdomadem (*hebdomas*) significant, quorum primus est deus Saturnus falcem (*falx*) gerens. indicibus ligneis in foraminibus

(foramen) positus et dies hebdomadis et dies mensis et ipse mensis anni indicatur. litterae signis (*signum*) zodiaci adscriptae haec significant: A = aquarius, P = pisces, A = aries, T = taurus, G = gemini, K = cancer, L = leo, B = virgo, L = libra, S = scorpio, S = sagittarius, K = capricornus. (B saepe pro V sumitur, K pro C, quia exeunte aetate Caesarum eodem modo pronuntiabantur.)

### ansa -ae, f.

est manubrium quo vas aut quodcumque aliud manu prehendi et teneri potest.

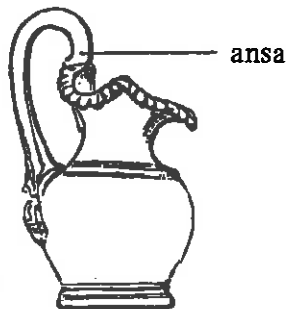

ansa statērae est pars illa, quae manu tenetur, habetque anulo suspensum scapum, qui in ea versatur.

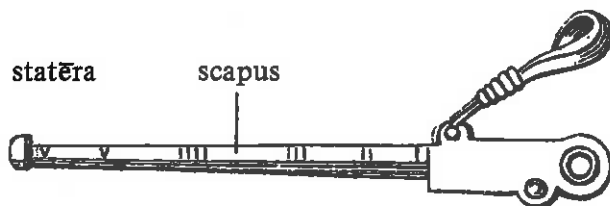

ansa gubernaculi est summa pars gubernaculi, quam gubernator manu tenet.

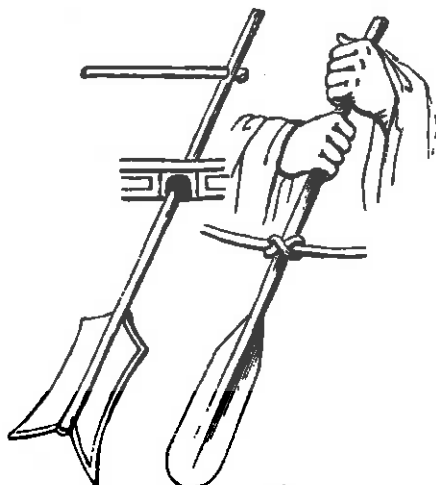

ansa ostii est anulus ferreus ostio (ostium) infixus, ad aperiendum, claudendum vel etiam pulsandum.

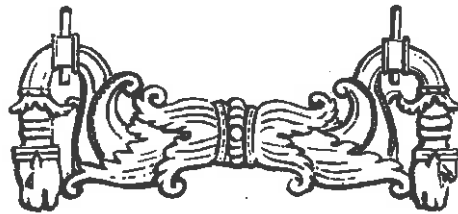

ansa crepidae aut vestium est vinculum et habenula, qua soleae (*solea*) et crepidae pedi alligantur, aut vestes in aliqua corporis parte constringuntur.

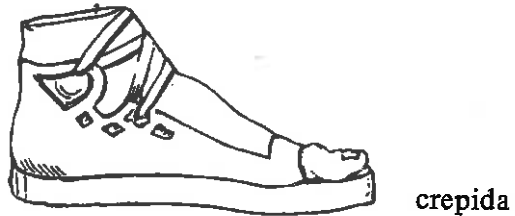

proverbium: ne sutor ultra crepīdam

### antae -arum, f. pl.

antae sunt pilae (*pila*) lapideae, seu columnae structiles quadratae, quae ad latera ostiorum

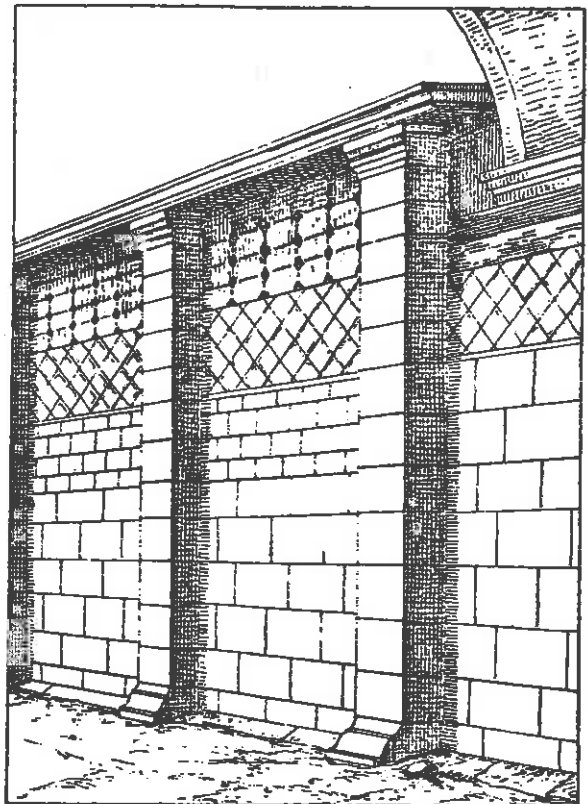

utrimque ponuntur, vel duae, vel quattuor, vel plures in frontibus aedium.

Vitruvius, 3, 2, 2:

„in antis erit aedes, cum habeat in fronte antas parietum, qui cellam circumcludunt, et inter antas in medio columnas duas, supraque fastigium ...“: fiunt antae non ad ornatum tantummodo, sed etiam ad muniendam et sustinendam structuram. (*templum*)

\*\*ab aetate media anta etiam pilastrum vocatur. (Du Cange)

### antefixum -i, n.

est parvum *signum*, corolla, aliudque huiusmodi ornamentum ex opere figulino, quod tecto aedis affigitur sub stillicidio. *stillicidium* est locus, unde aqua tectorum in terram decedit.



hoc antefixum fictile Argonautas cum dea Minerva monstrat

### antlia -ae, f.

est machina ad hauriendam ex imo loco aquam, quae pedum alterno nisu et agitato aquas per modiolos atque haustra attollit.

Martialis, 9, 18:

„sed de valle brevi, quas det sitientibus hortis, curva laboratas antlia tollit aquas.“

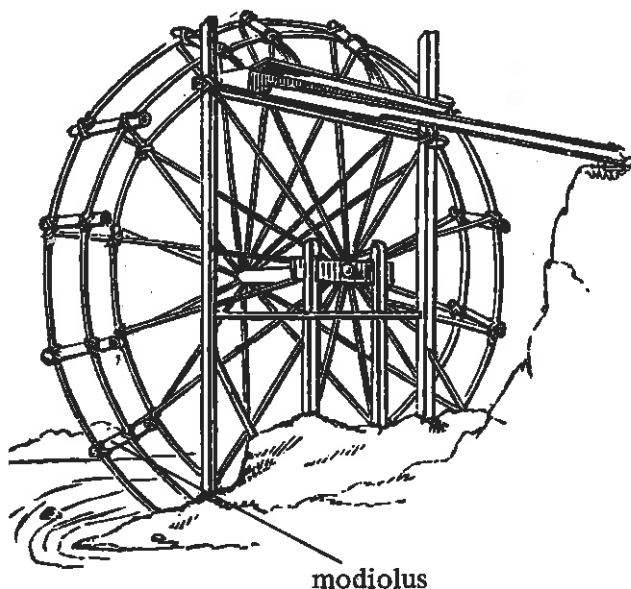

### antrum -i, n.

antrum est caverna, quae praecipue silvestrem quandam pulchritudinem prae se ferat, et aestatis tempore frigidum amoenumque recessum praebeat, aut alicui numini sacra sit. est vox poetis quam aliis usitatior.

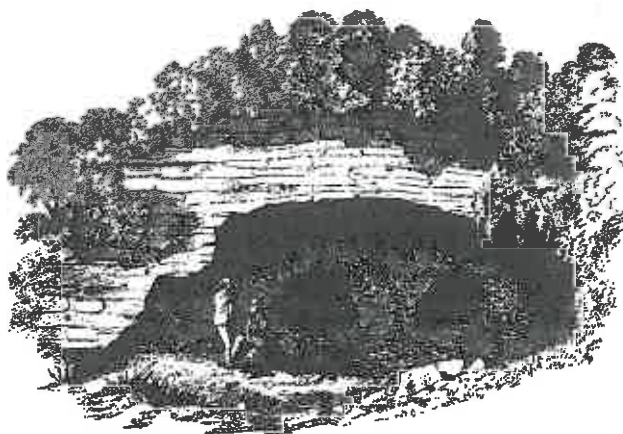

### aper -pri, m.

aper est porcus silvester.

Plautus, Cas. 476:

„iam ego uno in saltu lepide apros capiam duos“  
= unā fallaciā duos decipiam.



Ovidius, Met. 8, 283 ss:

„sanguine et igne micant oculi, riget horrida  
cervix  
et saetae similes rigidis hastilibus horrent  
...  
... dentes aequantur dentibus Indis.“



opus caelatum Coloniae Agrippinae inventum,  
aprum et canem venaticum repraesentans.

### apis –is, (pl. –ium), f.

apis (mellifica) est insectum volatile, mellis  
(mel, mellis n.) artifex.

Plinius, H. N. 11, 11:

„mella contrahunt sucumque dulcissimum atque  
subtilissimum ac saluberrimum; favos (*favus*)  
configunt et ceras mille ad usus vitae, laborem  
tolerant, opera conficiunt, rem publicam  
habent ...“

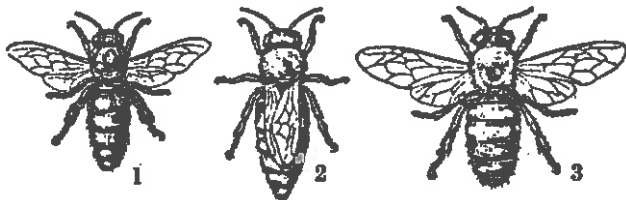

1 apis operaria    2 regina    3 fucus

### aplustre –is, n.

significat navis ornamentum ex tabulis con-  
fectum, et in summitate *puppis* positum, et  
plerumque in modum pinnarum aut cristae  
(*crista*) formatum et versus *proram* recurvum.

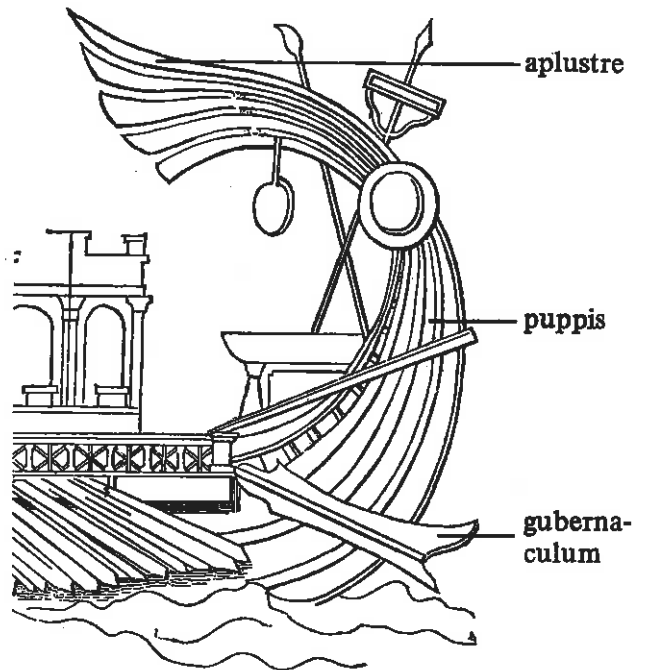

aplustre cum ancora

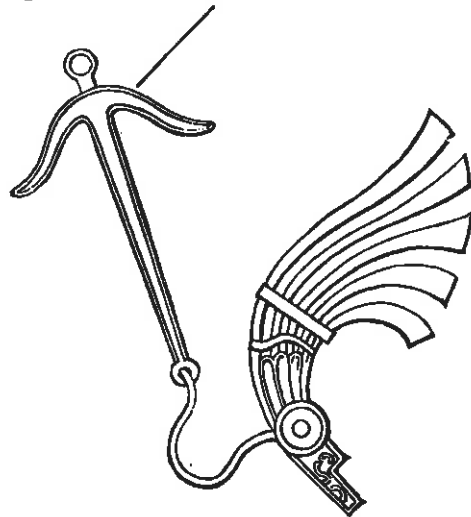

### Apollo –inis, m.

Apollo (vel Phoebus), Latonae et Iovis filius,  
frater Artemidis (Dianae)..Deus est vatum  
(*vates*), venator est munitus arcu (*arcus*) et  
sagittā, artibus Musarum (*Musae*) praesidet et  
eas ad choream ducit lyrā canens; etiam  
citharoedus dicitur, i. e. ad citharam vel lyram  
canens.

de Apolline Horatius in Carmine Saeculari  
(61/62):

„Augur et fulgente decorus arcu  
Phoebus acceptusque novem Camenis.“ (= Musis)

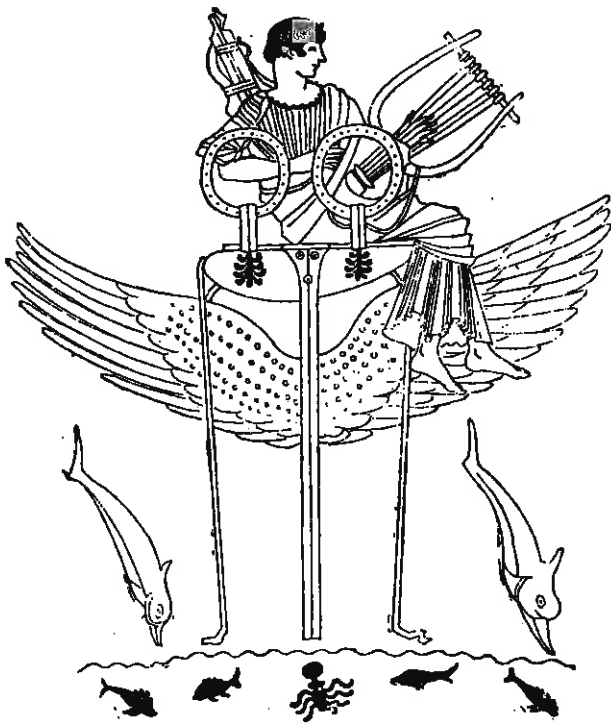

Apollo in tripode (*tripus*) sedens, supra mare volat, lyrā canens; arcu munitus est (= vates est, citharæodus et venator). (*arcus*)

### apotheōsis —is, f.



Thalia ab aquila Iovis in caelum sublata in pictura vasis Graeci

nomen graecum, relationem hominis in deos significans. quae relatio multis in fabulis narratur; nam Ganymedes, Thalia multique alii a Iove sub forma aquilae in caelum erepti esse dicebantur, sicut etiam Hylas a nymphis fontis, Oreithya a Borea, deo ventorum. hi homines, a deis rapti, immortalitate donati et semidei, i.e. heroes facti sunt.



eodem modo etiam *consecratio* imperatorum depingitur, ut in hoc opere caelato, ubi Titus ab aquila in caelum tollitur

### aqua —ae, f.

aqua humor est, unum e quattuor elementis, e quibus mundus constat.

aqua dicitur saepe de aquā deductā, sive de *aquae ductibus*, notissimae aquae sunt: aqua Alsietina, Appia, Caerula, Crabra, Marcia, Tepula, Virgo ...

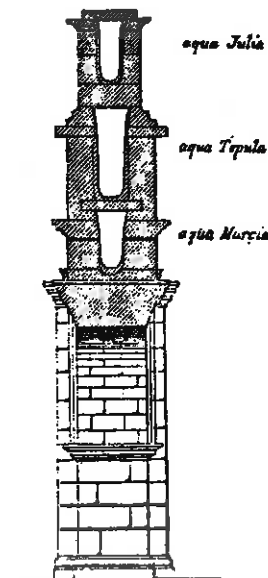

sectio Portae Sti. Laurentii, per cuius superiorem partem tres aquae ducuntur: aqua Iulia, aqua Tepula, aqua Marcia

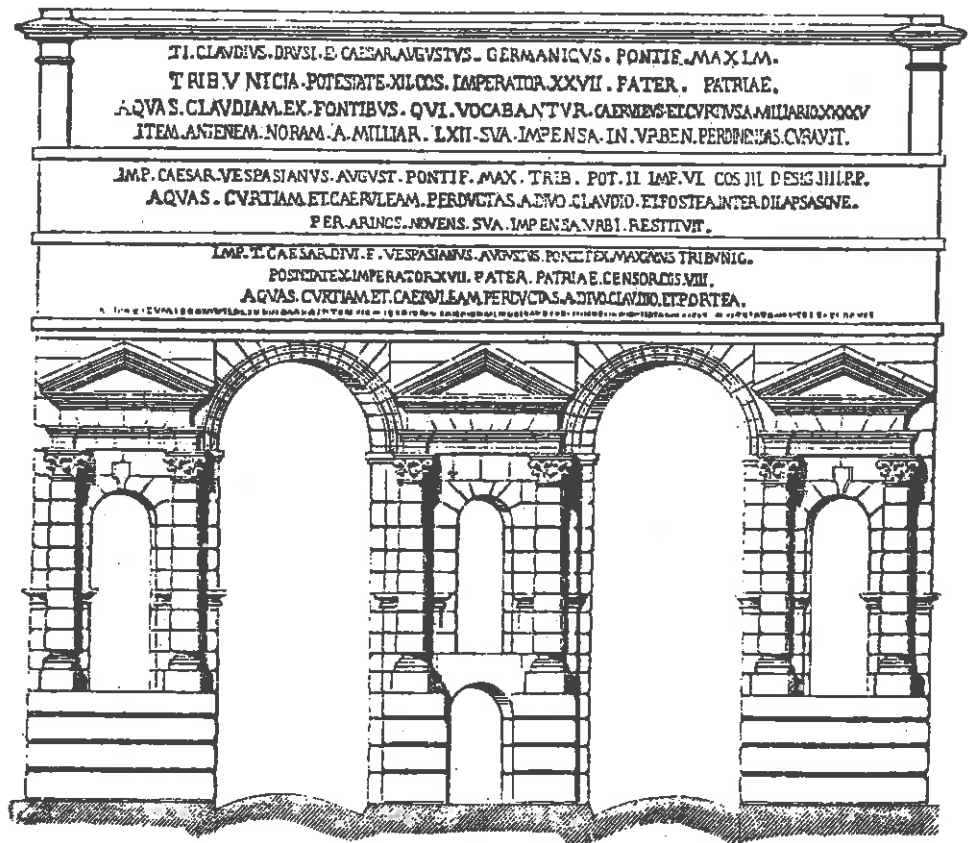

Porta quae dicitur  
 Maior. In titulis  
 constat, a quibus  
 aquae ductus  
 constructi sunt.

**aquaeductus** —ūs, m.

vel aquae ductus, est structura, quā aqua deducitur, sive ea subterranea sit per cuniculos (*cuniculus*), sive ex opere arcuato.

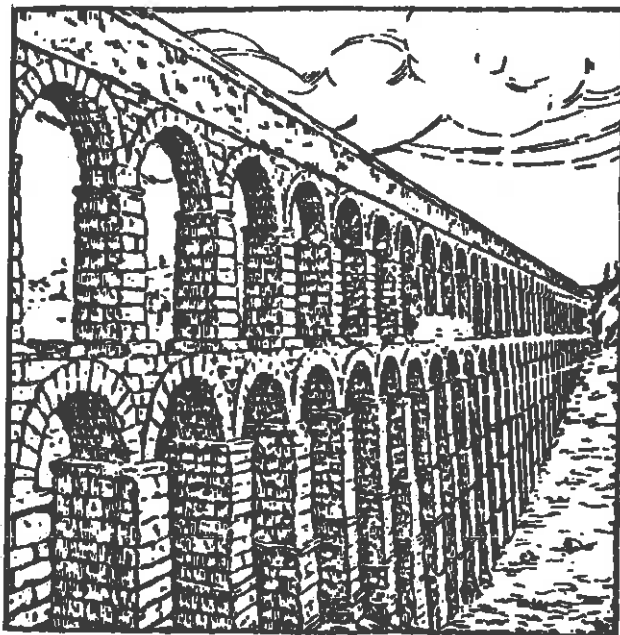

aquaeductus ex opere arcuato apud Segoviam  
 (in Hispania)

**aquila** —ae, f.

a) est avis ex genere rapacium, maximis valens viribus, ceterarumque pugnacissima et generosissima; ob id avium regina appellata.  
 b) quoniam in auguriis (*augurium*) volatus aquilae omnium prosperrimus a Romanis habitus est, factum est, ut aquilae signum in exercitu ferre instituerint. itaque principem locum inter *signa exercitus* aquila obtinebat, quae longae infixae perticae gestabatur, alis plerumque expansis et in unguibus tenens fulmina; singulae legiones suam habebant aquilam.

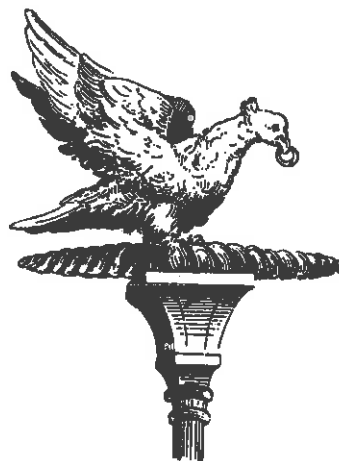

**ara** -ae, f.

a) ara est exstructio quae ex saxis, terrā, vel etiam lignis fit formā quadratā et superficie (*superficies*) planā.



ara cum  
statua  
Dianae

b) ara est locus exstructus saepe quadratā formā, sacrorum seu victimarum immolandarum causā. altare -is, n., pl. -aria, sunt loca ad sacrificandum apta; proprie altare est gradus super aram elevatus, in quo hostia igni adolebatur.

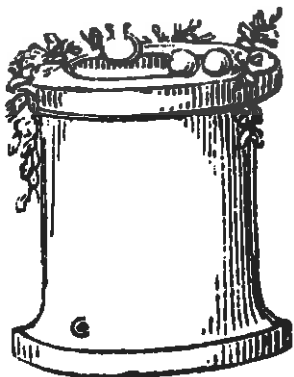

**aranea** -ae, f.

aranea est animal tenuem texens telam (*tela*) ad captandas muscas (*musca*).  
aranea etiam ipsa tela araneae nominatur. (*rete*)

**Plautus**, Aul. 84:

„ita inaniis sunt oppletae (sc. aedes) atque araneis.“

**Catullus**, 13, 7/8:

„... nam tui Catulli  
plenus sacculus est ... araneorum.“

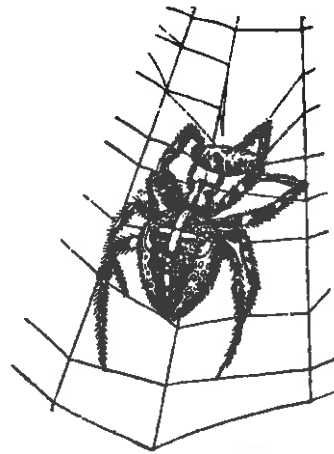

**aratrum** -i, n.

est instrumentum rusticum quo agri laborantur. prima imago aratrum simplex, e bure et vomere compositum, monstrat.

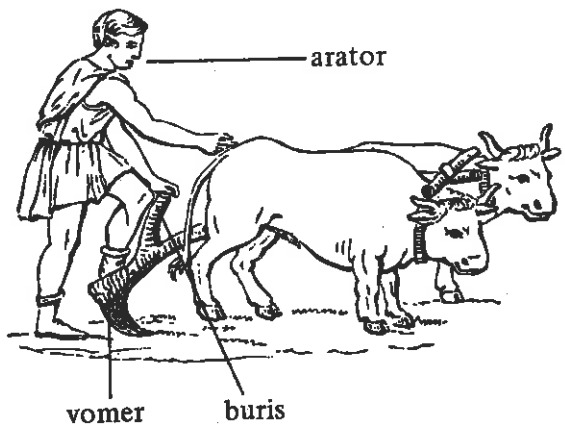

secunda imago aratrum perfectius continet.

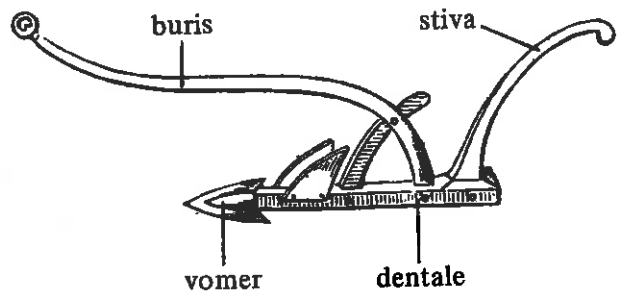

tertium aratrum rotis, temone et cultro instructum est.

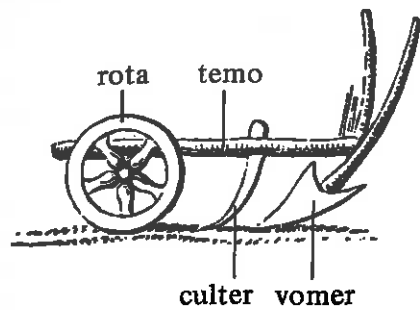

**arca -ae, f.**

arca est quidquid hominibus aut rebus claudendis et custodiendis inservit, receptaculum, in quo aliquid custoditur. in arca vestiaria vestes

reponuntur; arca usurpatur pro receptaculo nummorum.

formula: „ex arca domoque“ solvere aliquid = praesenti pecunia et ex domo sua debitum solvere.

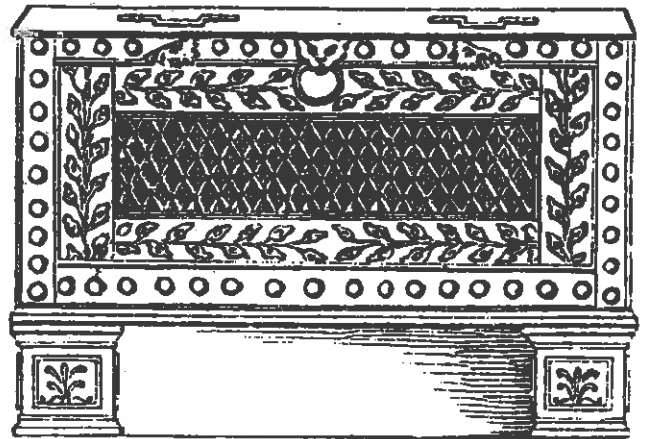

**architectus -i, m.**

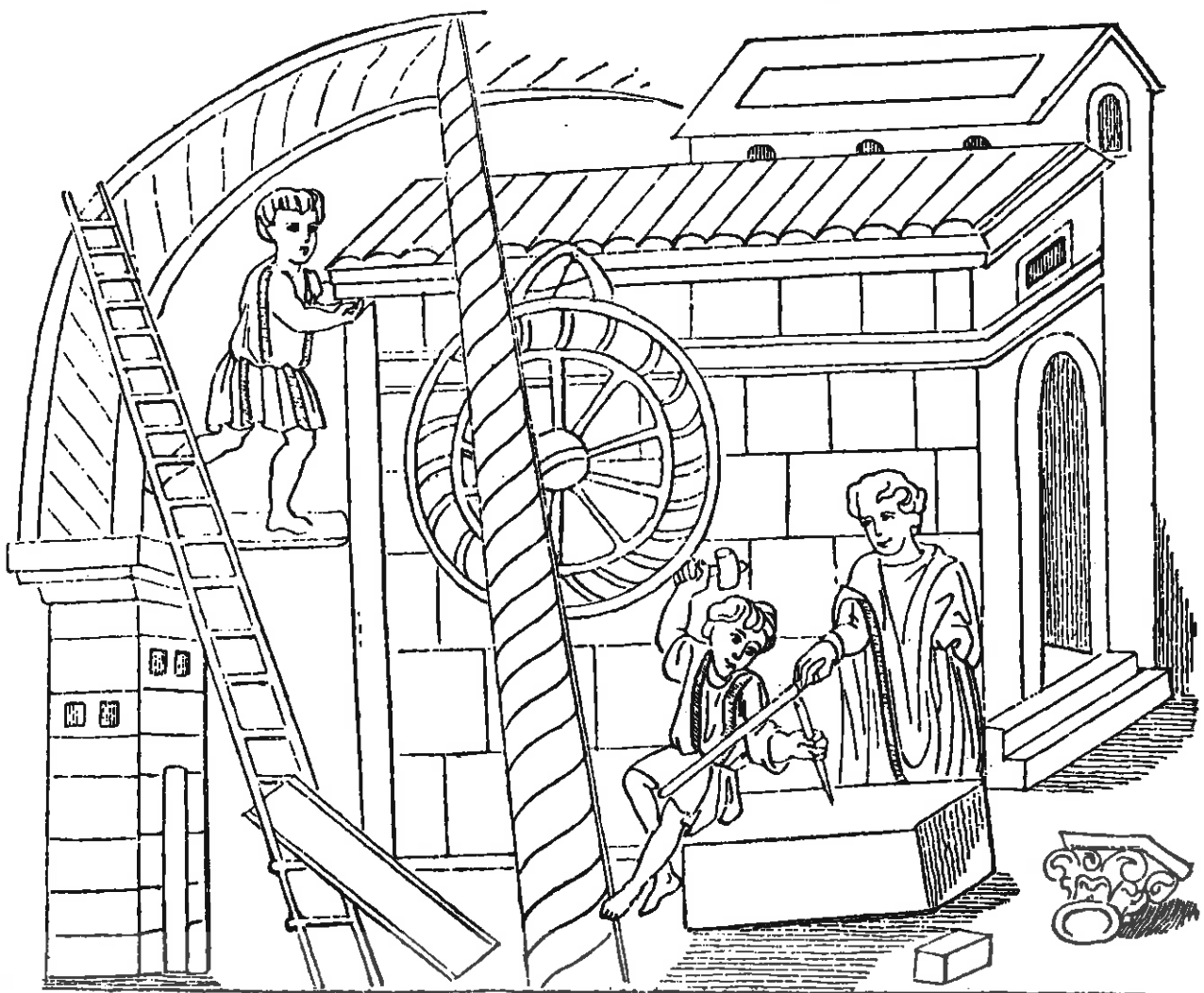

est praefectus structorum. (*structor*), accipitur pro eo, qui architecturae artem callet, et in aedificiis aliisque structuris symmetriam, decorem ac distributionem omni studio consecratur. proverbium: „architectus architecto invidet“, de iis, qui in eadem arte versantur, cuius similitudo aemulationem et invidiam conciliare solet.



architectus manibus stilum et *codicillum* tenens. sinistra *norma* in pariete pendet, dextra *perpendiculum*.

### arcus —ūs, m.

arcus est instrumentum ex ligno aut alia materia, quod intento nervo incurvatur et remittitur ad iaciendas sagittas.



sagittarius barbarus (bracas (*bracae*) portans!) manu dextra nervum arcūs tendit

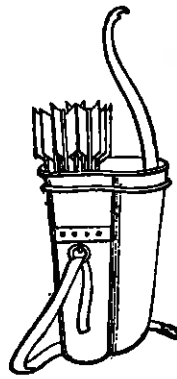

pharetra cum sagittis et arcū

translate ob similitudinem dicitur „arcus“ quidquid eiusdem arcūs formam prae se fert, v. g. arcus dicitur Iris caelestis. in architectura „arcus“ dicitur structura in modum arcūs curvata. huiusmodi sunt, qui a natura ipsa in antris formantur; qui substruuntur ad sustinendas aedes aut pontes (*pons*); qui ad *aquaeductus* erigendos, et qui eriguntur clari alicuius triumphus causa, ideo „triumphales“ appellati; quorum adhuc aliquot visuntur Romae et circa Urbem imperatoribus dicati ob insignes ab iis partas victorias.

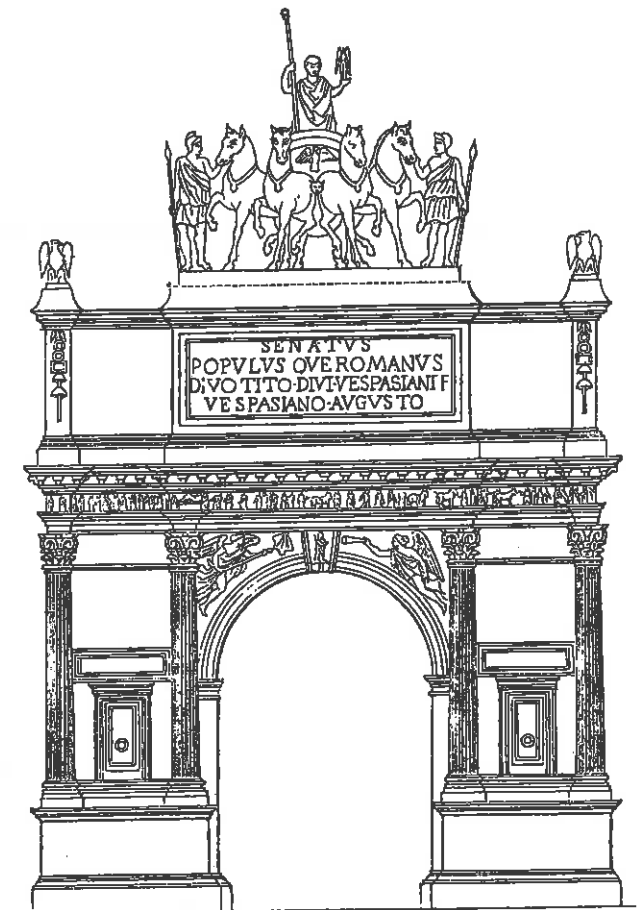

arcus Titi imperatoris Romae erectus. fastigium eius tenet currus (*quadriga*) triumphalis

## area -ae, f.

- a) area est locus vacuus et aridus, area est planities, in qua frumenta secta teruntur et arescunt.  
b) area dicitur locus in urbe purus, h. e. vacuus, in quo aedificari potest, et quod dirutis aedibus manet.  
c) item area dicitur locus vacuus inter urbana aedificia, cuiusmodi sunt plateae, etc. ex. gr. area Capitolii, area Palatina. in antiqua forma urbis Romae Area Radicaria indicatur. areae saepe amplis porticibus (*porticus*) cingebantur, ut venientium turba consistere posset.

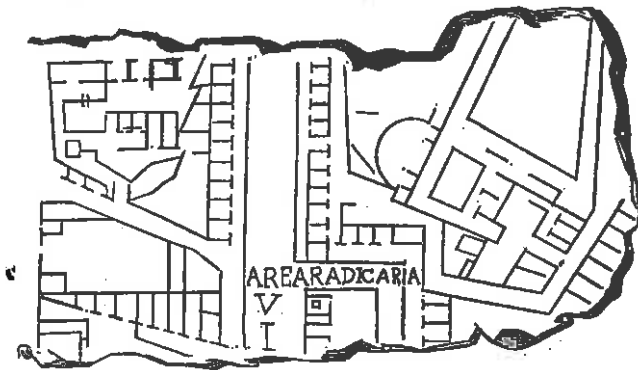

## argentarius -ii, m.

- a) argentarius est qui laborat circa argentum et ex eo opera facit, sive argentarius faber.  
b) argentarius est is, qui in pecuniâ negotiatur et lucrum quaerit pecuniis permutandis aut faenore dandis.



mensa argentaria, in pariete marsuppia et tabula

## Argo -us, f.

- a) fuit in fabulis *navis* celeberrima et prima dicta, qua *Jason* cum flore iuventutis in Colchidem navigavit *vellusque aureum* a *Medea* adiutus in Graeciam reportavit.

- b) est etiam sidus; fabulantur enim poetae a Minerva post peractam navigationem in caelum translata esse, quod sua ope et consilio facta, et quod prima percurrisset mare.



ope et consilio Minervae  
Argo exstruitur

## armamenta navis

- A prora
- B oculus
- C rostrum
- E puppis
- F aplustre
- H remi
- I gubernaculum
- K malus
- L velum
- M antenna
- N cornua
- S pedes
- T opifera

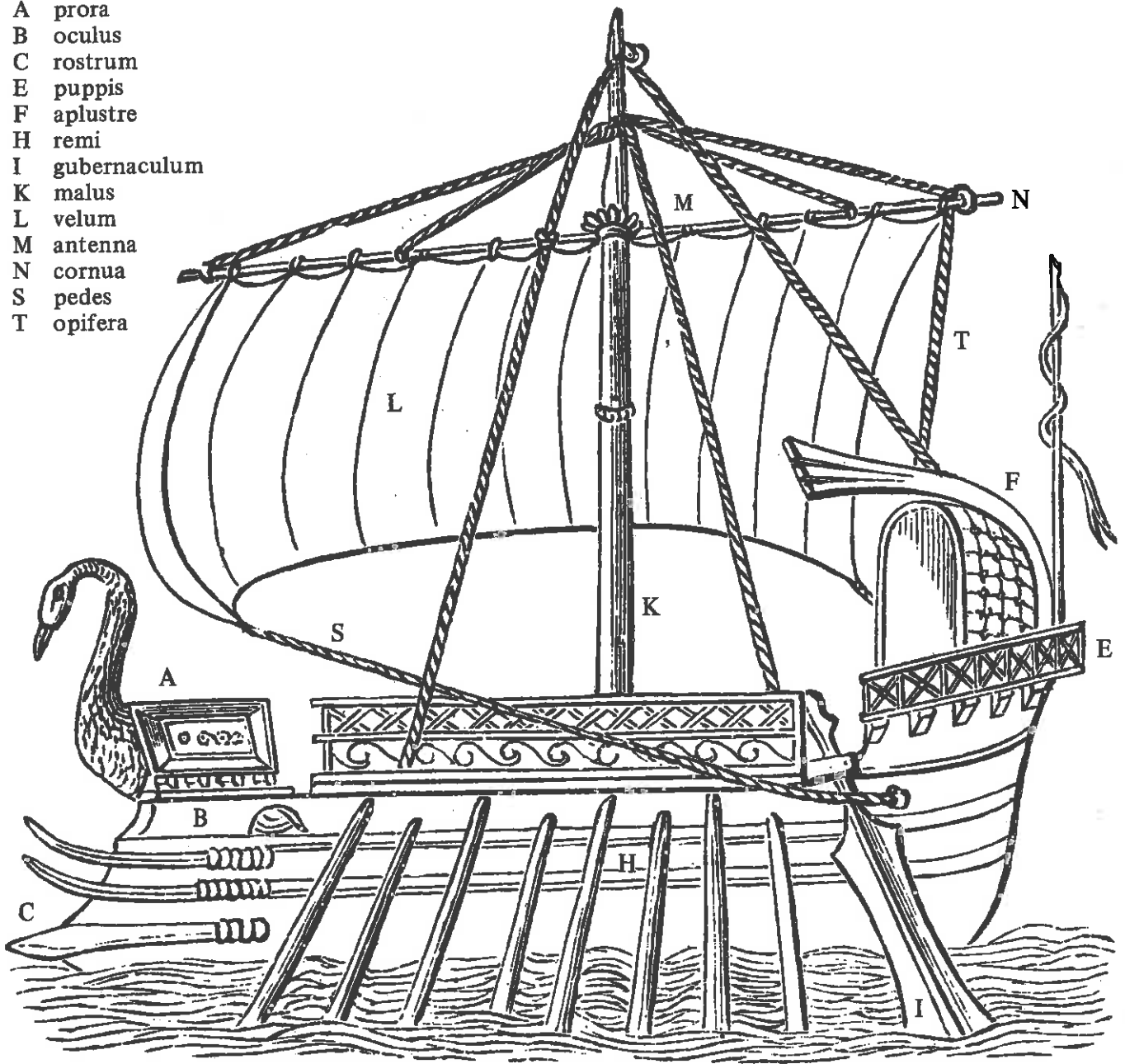

## armilla -ae, f.

est bracchiale, hoc est circulus, seu anulus ex auro, argento, aliāve materiā, quo bracchia virorum et mulierum ornantur; et quo etiam milites olim virtutis causā ab imperatoribus donabantur.



39

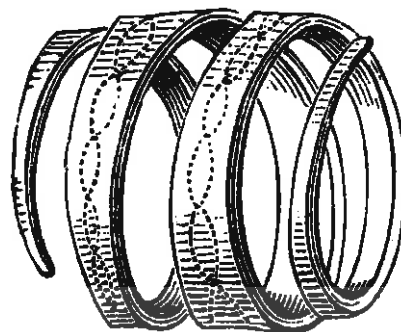

40



artes septem a. liberales

septem artes liberales sunt: grammatica, rhetorica, dialectica: trivium; arithmetica, geometria, astronomia, musica: quadrivium. his septem artibus pueri liberi instituebantur, unde artes liberales nominabantur.

trivium et quadrivium fundamenta sunt philosophiae. itaque in imagine ex Horto Deliciarum sumptā Philosophia tamquam regina in solio sedet, septem fluminibus ex pectore suo defluentibus septem artes nutrit.

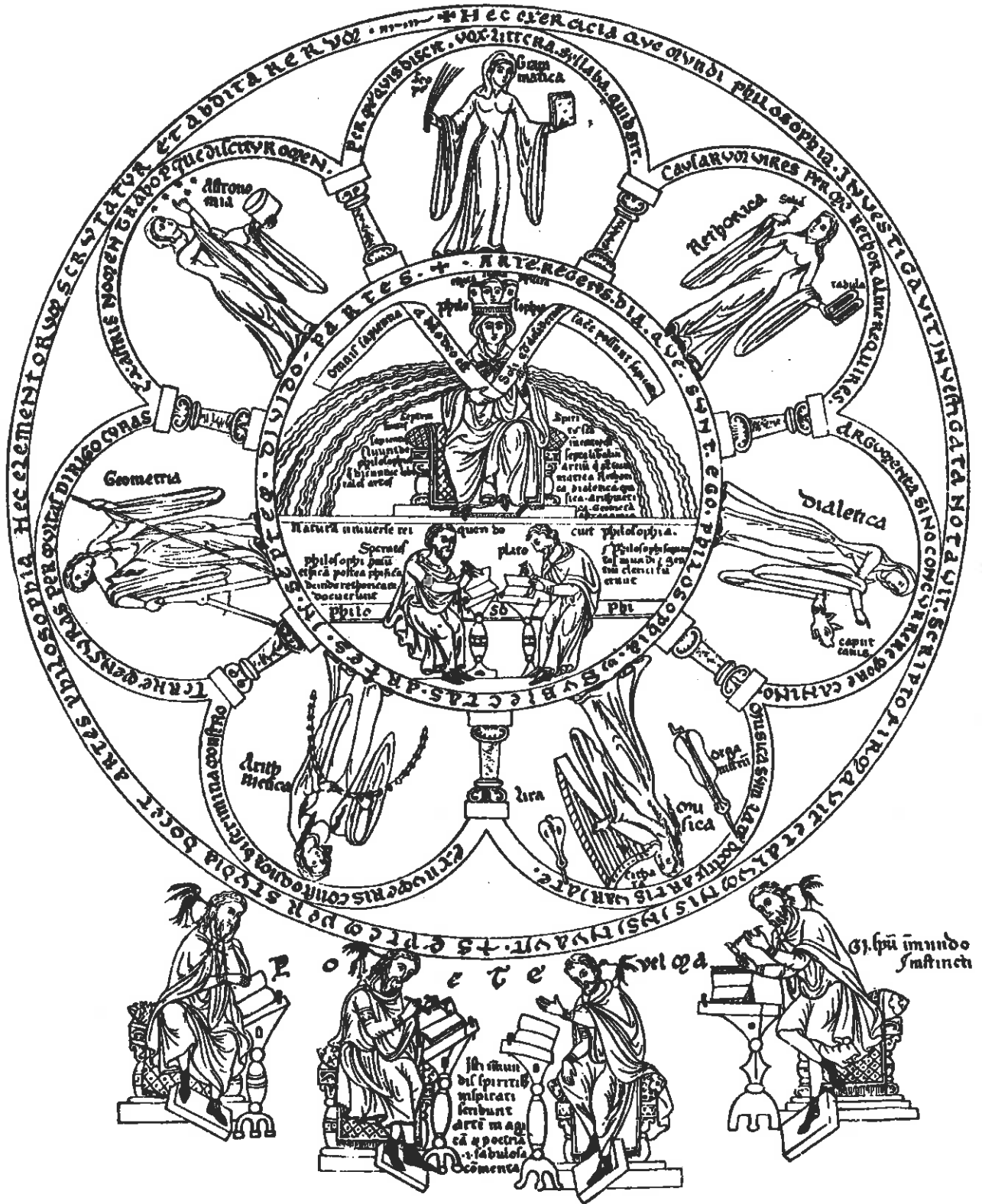

# artifices et artificia

artifex est qui aliquam artem exercet. sumitur non solum pro eo, qui artem mechanicam exercet, sed etiam qui liberalem (*artes liberales*).



1

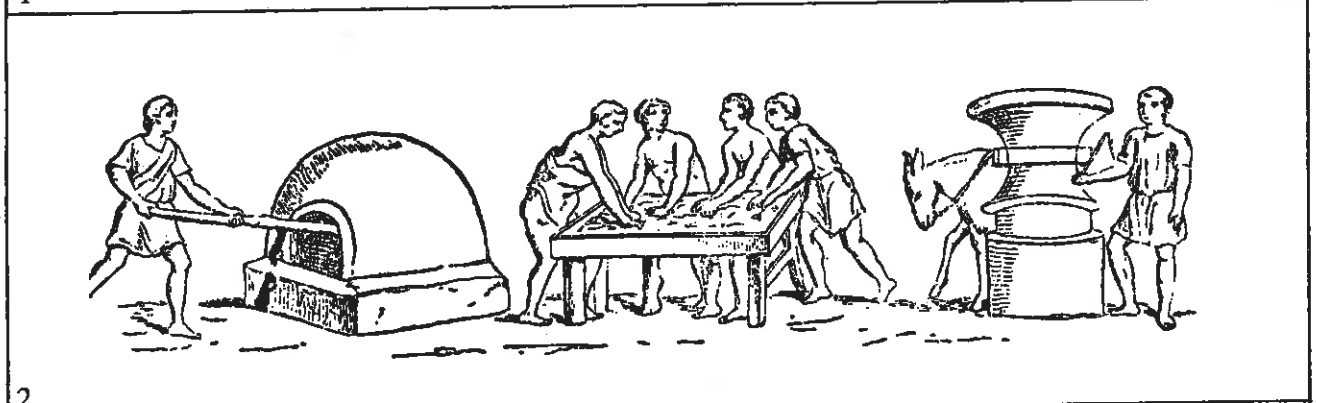

2



3



4



5



6



7

- |      |        |   |             |   |                |
|------|--------|---|-------------|---|----------------|
| 1, 2 | pistor | 4 | textor      | 6 | molinarius     |
| 3    | fullo  | 5 | macellarius | 7 | faber aerarius |

Nepos, Att. 13:

„erant in ea familia (sc. Attici) pueri litteratissimi, anagnostae (i. e. lectores) optimi, et plurimi librarii. pari modo artifices ceteri, quos cultus domesticus desiderat, apprime boni.“

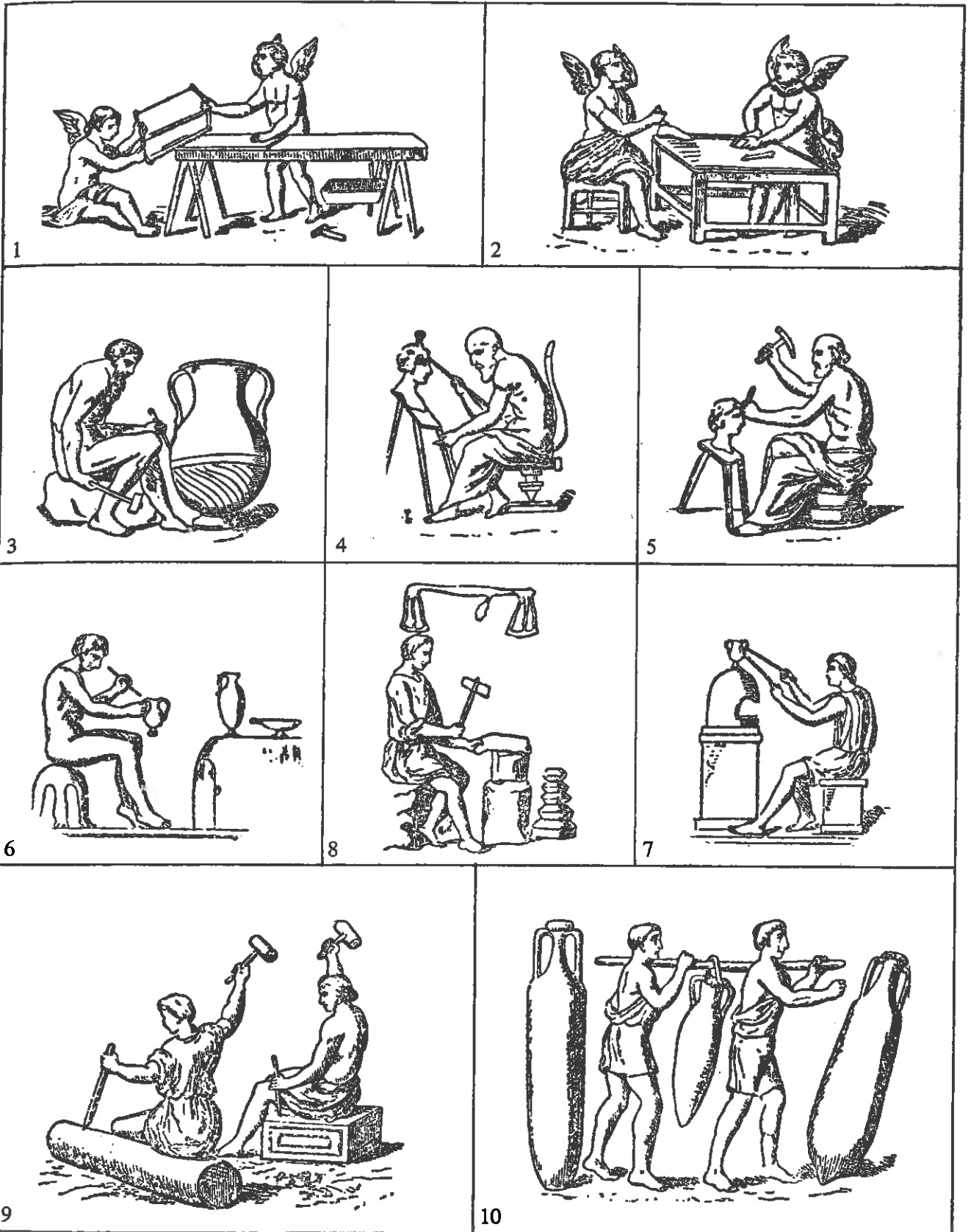

1 tignarius  
2 sutor

3 caelator  
4 figulus

5 sculptor  
6/7 figulus

8 aurifex  
9 lapiçida

10 vinarius  
(mercator vinarius)

## arx –cis, f.

arx est locus munitissimus urbis, summus et excelsus locus, cacumen, vertex montis, moenibus, turribus aliisque propugnaculis (*propugnaculum*) munitus. Romae arx erat in colle

Capitolino; Athenis, Corinthi, in aliisque per multis urbibus Graecis arx „acropolis“, h. e. „urbs in cacumine montis sita“ nominabatur.

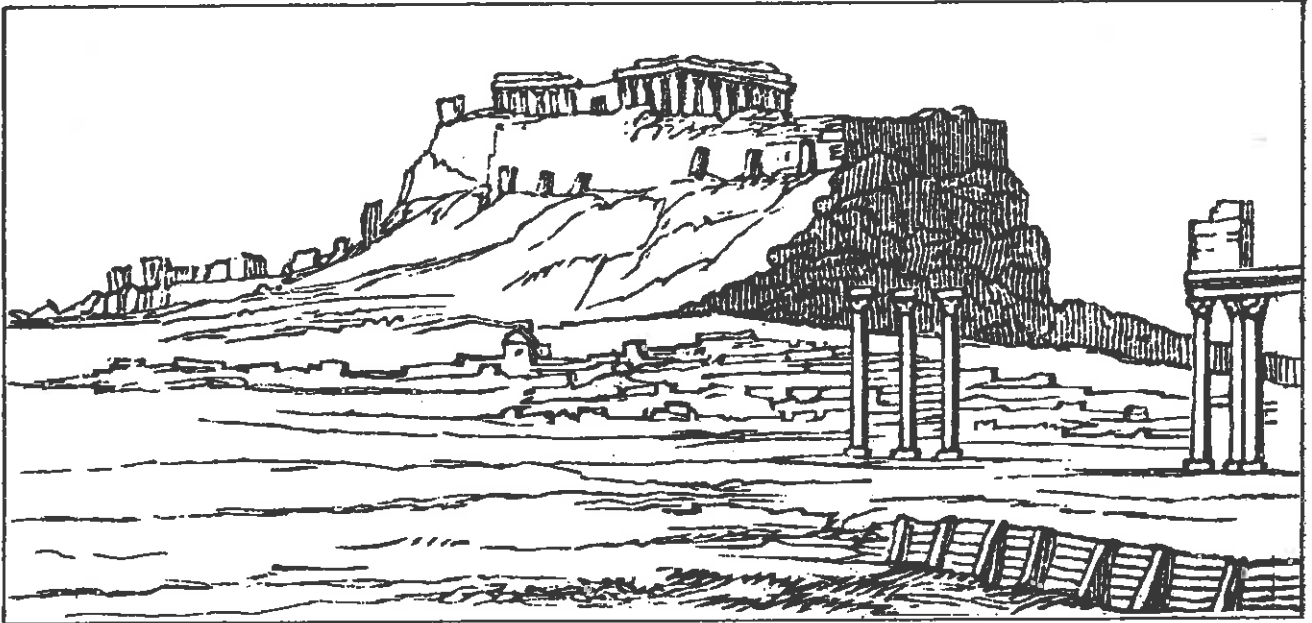

arx Athenarum

## as assis, m.

a) as erat unitas ad rem quamlibet metiendam, ponderandam, pretio aestimandam.

b) pecunia ex aere facta, qua usi sunt Romani priore quidem tempore rudi, postea signatā: illa appendebatur *librā*. una ex parte Iano gemino, altera ex parte rostro (*rostrum*) navis aut capite Mercurii notatus erat as.

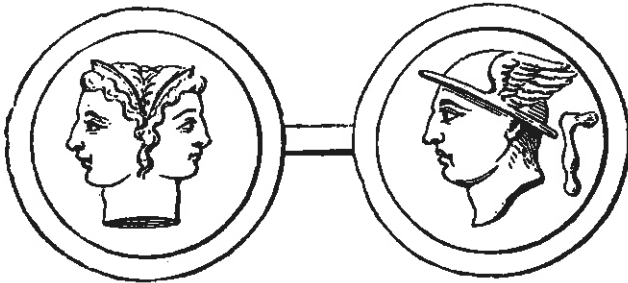

## ascia –ae, f.

a) ascia significat quodcumque instrumentum findendo, secando, fodiendo, evellendo, percutiendo idoneum.

b) saepius est instrumentum ferreum, quo utuntur fabri lignarii ad ligna dolanda et polienda, ferrum habens latum et incurvum, manubriumque breve, ita ut tractari una manu possit. proverbium: „ipse mihi asciam in crus impegi“ = id, quod molitus sum, mihi ipsi perniciei fuit.

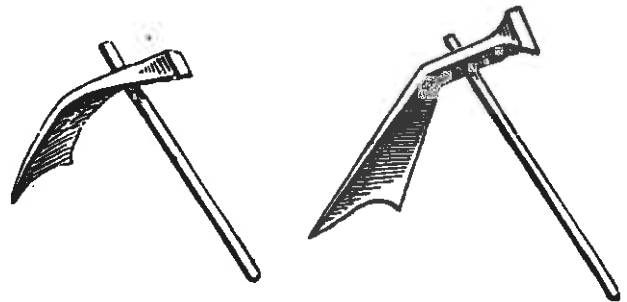

## aspersio –onis, f.

est actus aspergendi, se aquā perfundendi; genus est lavationis ante sacrificia.

in imagine, famula aquam aspersionis *situlā* haurit, sacerdos ramum de arbore frangit, quo aspergat dei cultores.



aspersorium est instrumentum, quo participes sacrificii asperguntur.

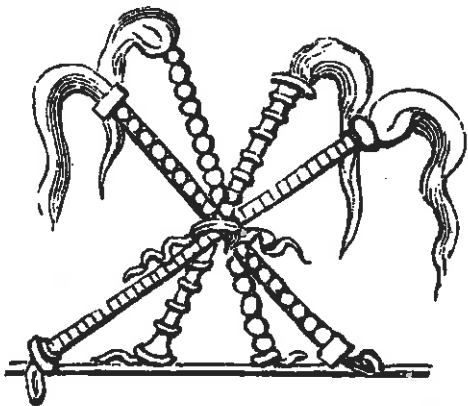

aspersoria

### astragalus -i, m.

- a) Graeca vox astragalus significat talum (*talus*) pedis tum in homine, tum in animalibus, quo etiam in ludis utebantur.
- b) a Vitruvio pro membro architecturae, quod figurā astragalum imitatur: habetque locum in basibus columnarum, in superciliis, in coronis et alibi.

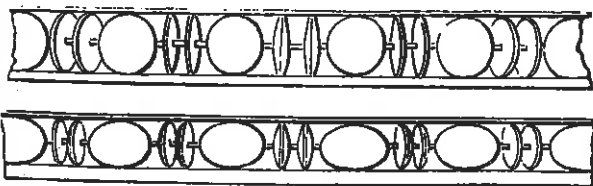

astragalus

### Atlas -antis, m.

filius Aetheris et Diei; rex Mauretaniae. dux fuit Titanum, qui bellum intulerunt Iovi, a quo victus iussusque est ut in rebellionis poenam molem caeli sustineret.

Atlas etiam est nomen montis Africae, de quo Vergilius, Aen. 6, 797:

„... ubi caelifer Atlas

axem humero torquet stellis ardentibus aptum.“

Atlantes in architectura dicuntur iidem, qui telamones - figurae hominum qui columnarum vice tecta aedificiorum sustinent.



### atomus -i, f.

Gr. atomos = individuus, qui sectionem non recipit. atomus est corpusculum minutissimum, quod sectionem non recipit.

Democritus (V. a. Ch. n. saeculo) primus opinatus est ex atomis mundum et omnes mundi partes factas esse, et omnia fieri, quae in mundo gignuntur: motum atomorum aeternum esse.

\*\*\* hodie vis atomica divisione aut sectione nuclei (nucleus) atomi reserata, maximam potentiam efficit.

\*\*\* pyrobolum vi atomica explodens terrificantem vim destructionis obtinet.

**augur** —uris, m.

lituus



augur dextra manu lituum gestans; ad eius pedes est avis sacra

est vir, qui auctoritate publicā sacras aves alit, custodit atque observat, et ex iis futura divinat. multus fuit augurum et usus et honos apud Romanos. tanta sacerdotio augurum erat auctoritas, ut nihil belli domique Romani gererent, nisi prius per augures deorum voluntatem explorassent. augures initio tres fuerunt, creati a Romulo, ad quinque autem a Numā creati. posterioribus temporibus saepe collegium augurum ampliaturum est.

**augurium**, —i, n., est sacrarum avium educatio, animadversio atque ex iis rerum futurarum divinatio. ex volatu avium capiebant Romani

**augurium prosperum** quidem, si a sinistra parte auguris advolassent, **adversum** autem, si dextera. etiam e fulmine laevo laetum, e dextero triste augurium putabant.



augur Coruncanus a Iunone Sospita coronatus

**lituus** —i, m., est baculus incurvus, quo augures sedentes avibus **templum** designabant. lituo Romulus **regiones** (= templa) direxit, tum, cum urbem condidit.

**aurifex** —ficus, m.

aurifex est faber aurarius, i. e. faber qui ornamenta aliasque res ex auro facit vel auro induit. (*bractea*).

Cicero, in Verrem, 4, 25, 56:

„cum vellet sibi anulum facere, aurificem iussit vocari ... et ei palam appendit aurum.“

**auris** —is, f.

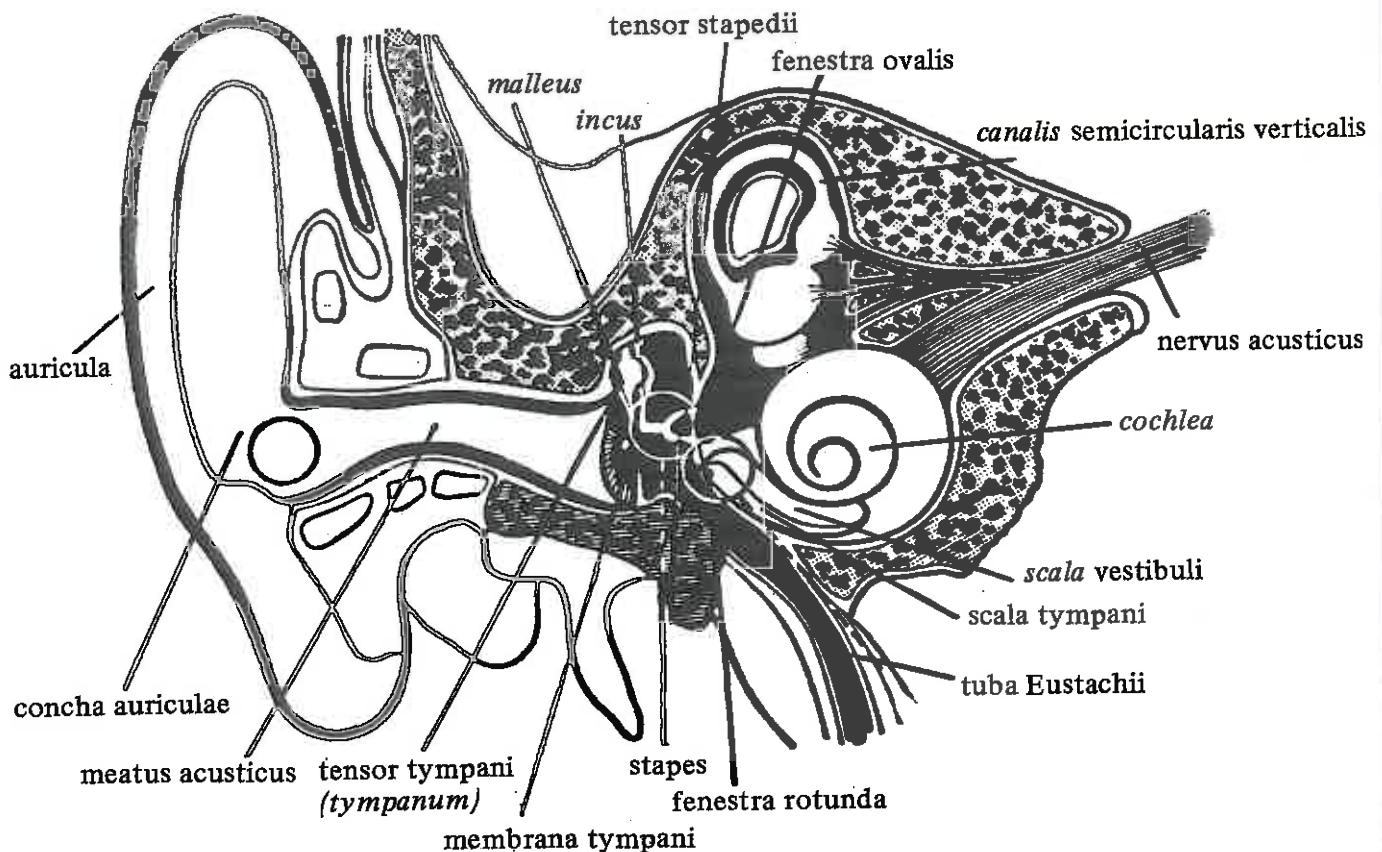

## Aurora –ae, f.

est initium diei „quo aer ab igne solis tum aureo aurescit“ ut ait Varro, L. L 7, 83. in fabulis Aurora est filia Hyperionis et Aethrae; mater Memnonis, qui ab Achille ante Troiam occisus est, quem mater cottidie matutino rore deflere dicitur.



in imagine e vaso Graeco sumptā Aurora quadrigam ducit praeunte Phosphoro (Latine: Lucifero). ambo nimbo (*nimbus*) praediti sunt. polypus, piscis et delphinus mare indicant, e quo Aurora emergit.

## auspicium –ii, n.

auspicium est avium observatio et ex earum volatu, cantu etc. futurorum praedictio.

Plautus, Amphitr. 196:

„ut gesserit rem publicam ductu, imperio, auspicio suo.“

verbum: auspicari, est inspectionem avium facere ad divinanda futura.

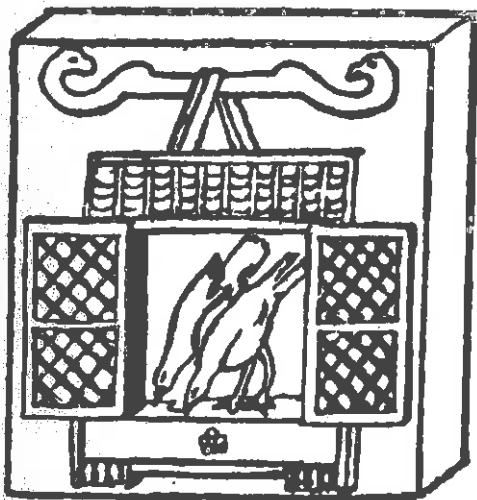

cavea, in quā aves ad auspicium praeparantur.

## avena –ae, f.

est culmus seu stipula cuiuscumque herbae. avena sativa est esculenta, quae iumentis in cibum datur, folio et stipulā tritico similis. apud poetas avena pro fistulae calamis ponitur. Ovidius, Met. 8, 191/2:

„... sic rustica quondam fistula disparibus paulatim surgit avenis.“

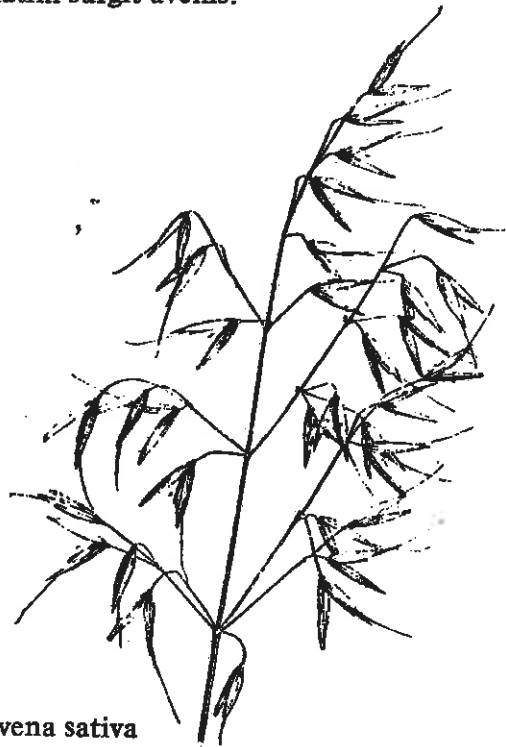

avena sativa

## axis –is, m.

est res quaecumque, circa quam alia res vertitur, speciatim est lignum illud teres, circa quod *rota* currūs vertitur.

item axis dicitur linea imaginaria, quae ab uno caeli cardine (*cardo*) seu polo, per centrum terrae transiens, in alterum terminatur: circa quam universa mundi machina circumvolvi dicitur.

Cicero, de natura deorum, 1, 20, 52:

„mundus versatur circum axem caeli admirabili celeritate.“

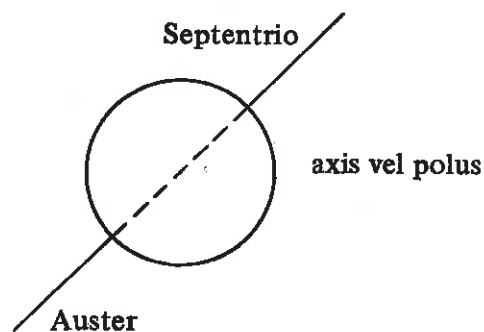

## baiulus —i, m.

baiulus est qui corpore onera portat.  
Plautus, Poen. 1353/4:  
„sume hinc quid lubet.  
Collo rem solvam iam omnibus,  
quasi baiulus.“

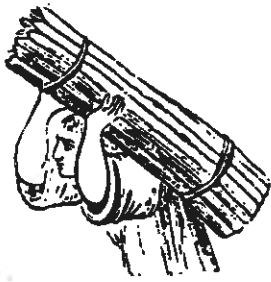

## balaena —ae, f.

balaena est belua marina ingentis magnitudinis,  
quae pilos in cute habet et vivum animal, non  
ova parit, fetūsque suos mammis nutrit.  
Plautus, Rudens 545/6:  
„Quaenam balaena meum voravit vidulum,  
aurum atque argentum ubi omne compactum  
fuit?“

BALAENA ERRECTA GRANDI NAVI SUBMERGENS.



## balneum —i, n.

in hypocausto ignis ad calefaciendas concamerationes superiores alebatur. balneum (calidarium) conclave erat magnum, in quo ingens labrum videmus, cuius orae latiori, qui se lavabant, insidere poterant. concamerata sudatio sudantibus erat destinata. iunctum huic camerae est laconicum tamquam forax immittendo calori aptum (idem erat, quod hodie Sauna Fennica nominatur). pone sudationem tepidarium videmus, in quo tepidior aer inter calidum frigidumque medium quasi tenebat. tepidario haerebat frigidarium et apodyterium (= vestiarium, vestiarius), in quo vestes deponere solebant.

primo in frigidarium intrabatur, ubi veste deposita corpus defricabant; hinc ad tepidarium transitus erat, unde post aliquantum temporis in sudationem procedebant; ex hac in balneum tandem calidum (i. e. in calidarium) perveniebant. Eodem ordine regredientes post lotionem in sudationem denuo intrabant, ibidemque aliquantum temporis commorati ad tepidarium et ex hoc ad frigidarium pergebant, ubi vestes induebant.

saepe in frigidario baptisterium erat, ampla piscina ad natandum. (apud ecclesiasticos scriptores speciatim baptisterium erat locus, in quo baptismi sacramentum solemniter administrabatur).

thermae, balnea publica erant, quae in omnibus oppidis urbibusque imperii Romani magno sumptu aedificabantur. sed etiam in domibus villisque rusticis balnea privata eadem ratione instituta erant.

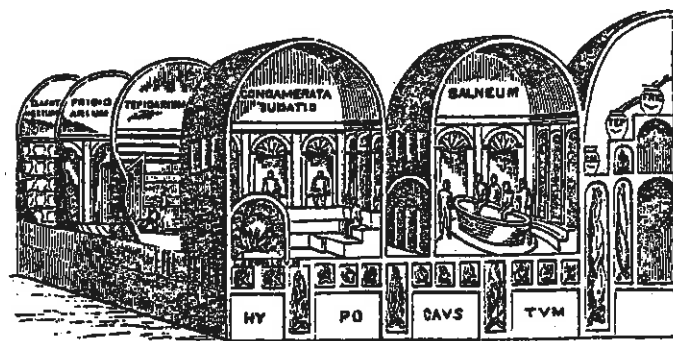

(imago e Thermis Titi imperatoris proveniens)

## balteus —i, m.

a) cingulum militare, ab humero dextro sub sinistrum brachium descendens, transversum pectus cingit.



balteus militaris (a)



balteus equi (b)

b) balteum dixere zonam, qua ephippia (ephippium) equorum dorso adstringuntur, vel potius lorum pectorale, quod bullis (bullae) aureis ornari solet.



c) apud astronomos est *zodiacus*.

Manilius, 1, 679:

„sed nitet ingenti stellatus balteus orbe.“

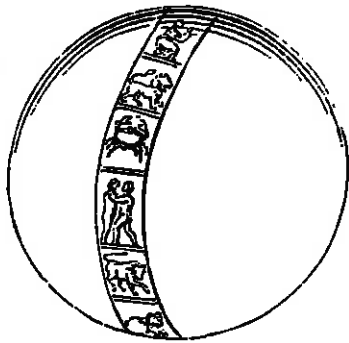

balteus zodiaci (c)

d) baltei in theatris dicuntur praecinctiones, quibus ordines spectatorum ab aliis separabantur.

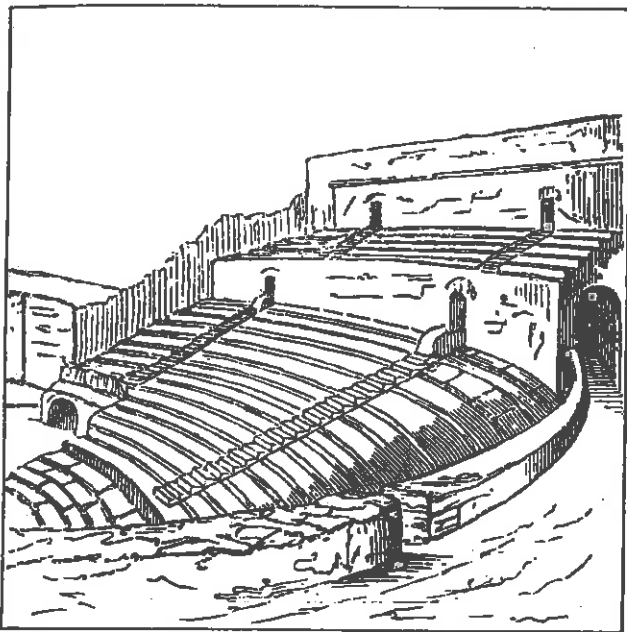

balteus in theatro (d)

## baptisterium –i, n.

est *piscina* frigida in frigidario (*frigidarium*) balnei (*balneum*), ubi post sudationem summissi sunt Romani. baptisterium a verbo Graeco „baptizo“, „submergor“ nominatur. in piscina baptisterii Christiani sacramentum baptismi administrabatur, unde primae ecclesiae Christianae etiam baptisterio, aedificio rotundo cum piscina, praeditae erant.

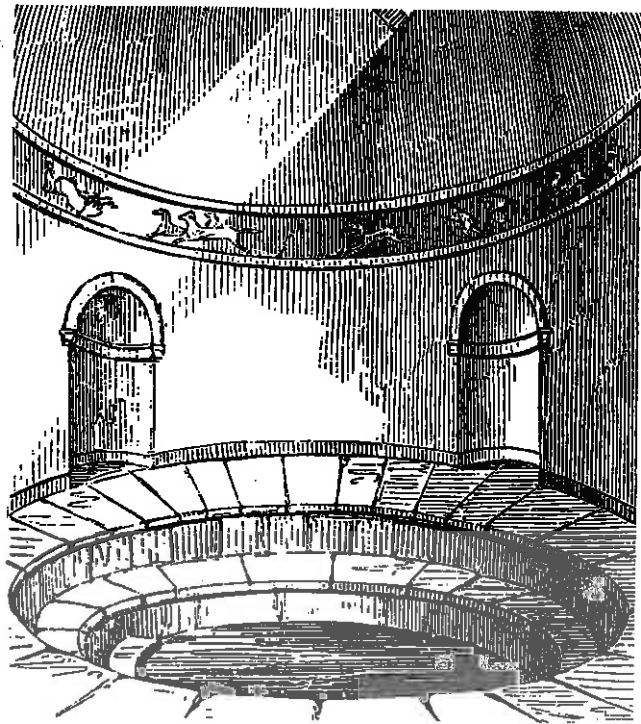

## basilica –ae, f.

a) proprie domum regiam significat Graece.

b) quia vero regum aedes ampliores esse solent

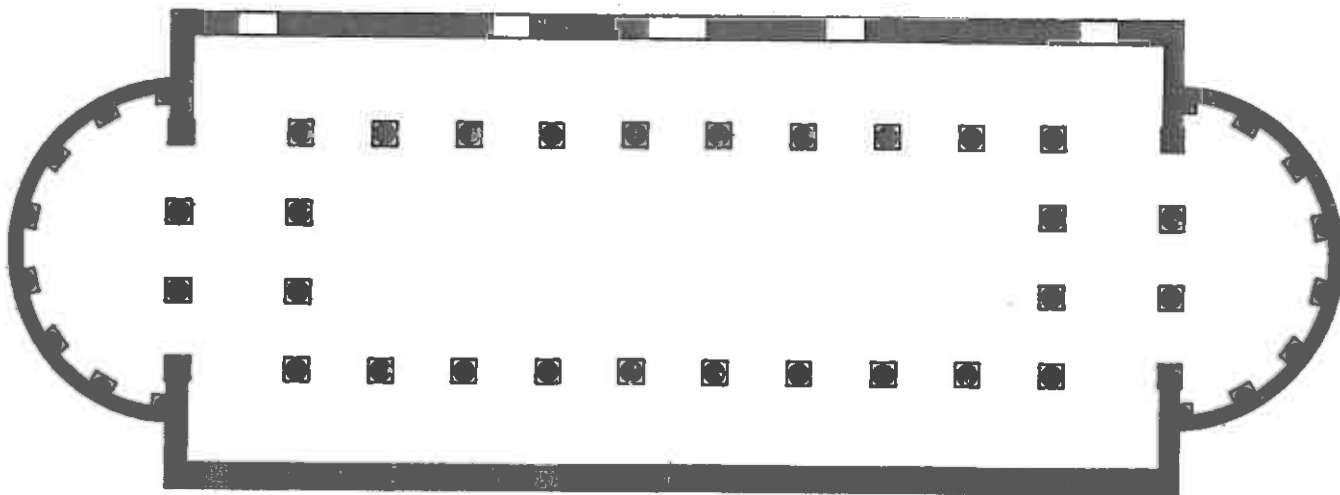

ichnographia basilicae Augustae Rauracorum prope Basileam sitae

atque ornatiores, Latini aequae ac Graeci basilicas appellaverunt aedes publicas spatiosis membris et ambulationibus instructas porticibusque (*porticus*) amplis saepe circumdatas. Saepe basilicae erant aedificia ad populi com-

modum facta, ut haberet, quo convenire posset ab aëris iniuriis munitus et negotia sua sub tecto agere. Hic etiam saepe iudicia exercebantur.

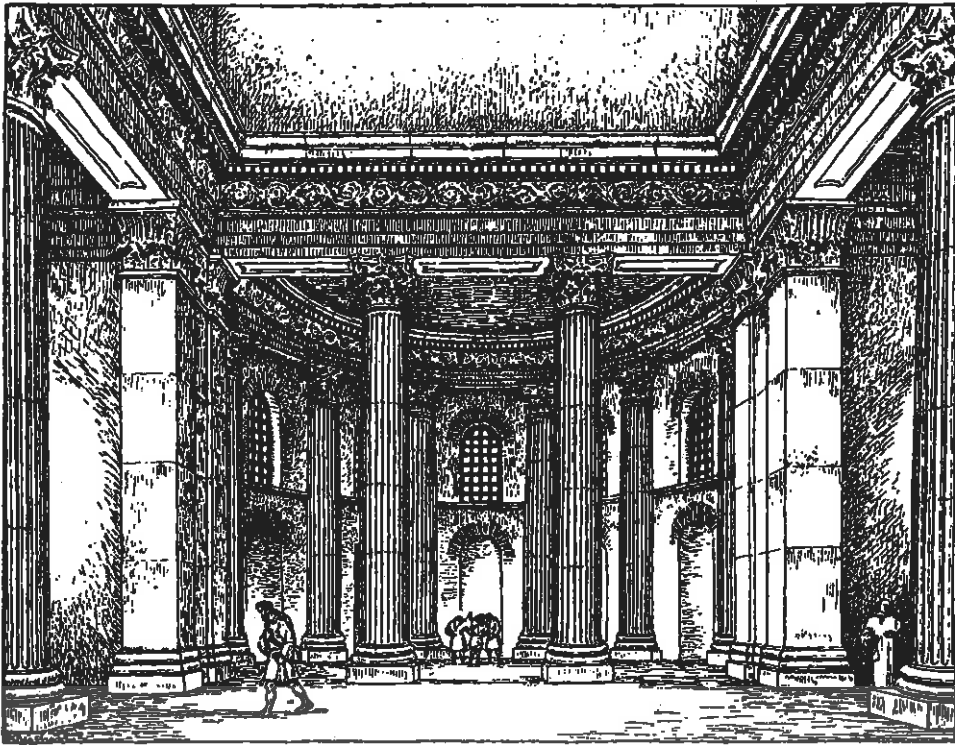

interior pars basilicae  
versus apsidem

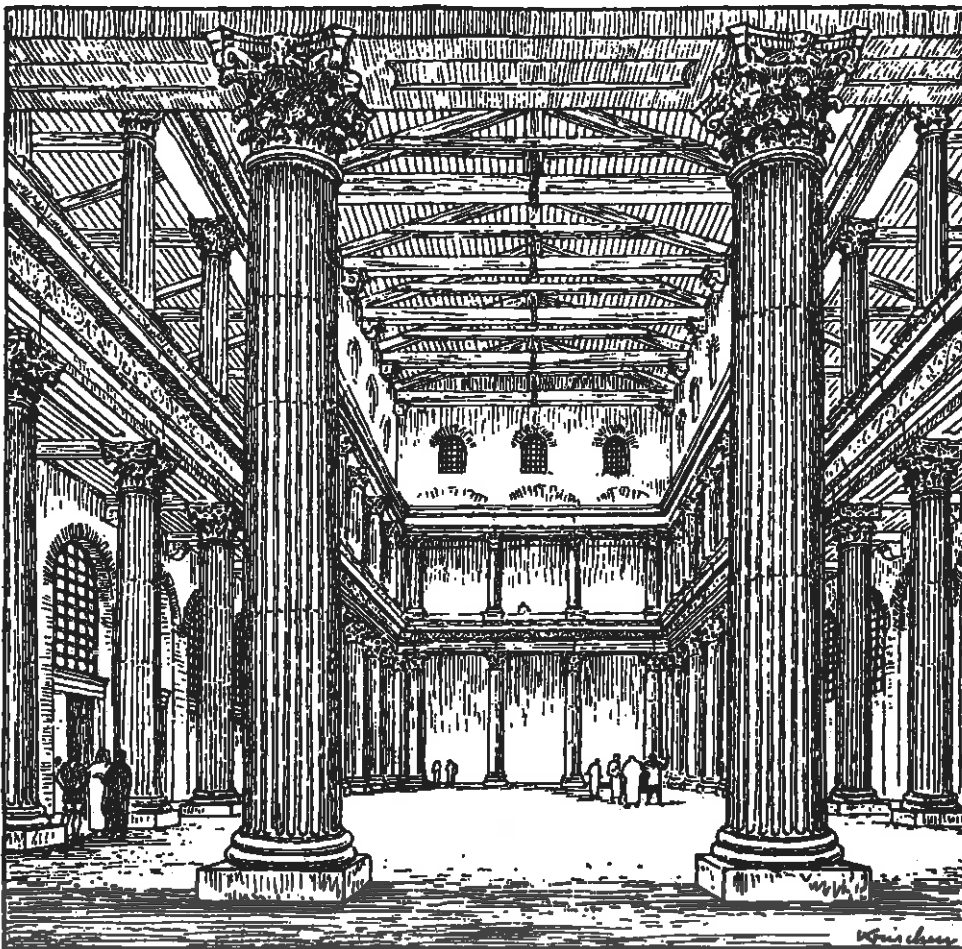

interior pars basilicae  
(reconstructa) Augustae  
Rauracorum



filius Neptuni et Eurynomes, Nisi filiae, rex Ephyrae, sed regno spoliatus a Proeto, Argivorum rege. apud illum eius iussu aulicam vitam peregit. corporis pulchritudine, simul et praeclarissimis maximisque virtutibus excelluit. cum a Sthenoboea, uxore Proeti, interpellatus esset, veritus hospitalis Iovis iram, lascivam feminam reppulit. quare exardescens repulsa mulier, apud virum innocentem hospitem accusavit, qui hospitii iure motus illum domi interficere non sustinuit, sed, datis codicillis, ad Iobatem, socerum in Lyciam misit. lectis ergo codicillis, Iobates in ultionem criminis multis periculis eum obiecit, quae facile superavit. postremo ad interimendam *Chimaeram* missus est; quem etiam laborem, nactus Neptuni beneficio Pegasus, equum alatum, summa cum laude superavit.

postea vero Bellerophontes, felici rerum successu elatus, cum in caelum evolare cum Pegaso conaretur, ab Iove equo excussus decidit in terram.

## \*\*biblia pauperum

ante typos (*typus*) a Gutenberg inventos impressi sunt libri xylographiis (*xylographia*) totam paginam complectentibus. ut imagines ita litterae in tabulam ligneam incisae sunt. maior pars paginae imaginibus et paucis versibus vel titulis completa erat. in imagine exem-

pla Veteris et Novi Testamenti opposita sunt et quam paucissimis verbis declarantur. „pauperum“ biblia nominatur, quia hoc opus illiteratis vel parum litteratis proponebatur.



\*\*\*bibliographia —ae, f.

bibliographia est recensio omnium librorum ad genus quoddam litterarum vel scientiarum pertinentium. bibliographia titulum, auctorem, tempus et locum editionis, interdum etiam compendium operis praebet. Primus qui bibliographiam in lucem edidit, fuit Conradus Gesner Turicensis in opere, cuius *frontispicium* secundae editionis hic apparet.

**BIBLIOTHECA**  
**INSTITUTA ET COLLECTA**  
 PRIMVM A CONRADO GESNERO.  
 Deinde in Epitomen redacta & nouorum Libroru acclensione locupletata, iam vero postremo recognita, & in duplum post priores editiones aucta, per Iosiam Simlerum Tigurinum.

*HABES hic, optime Lector, catalogum locupletissimum omnium fere scriptorum, à mundi initio ad hunc usque diem, extantium et non excussorum, publicatorum et passim in Bibliotheca Latina. Opus non Bibliothecae tantum publicae praeclarissimae instituta, sed studio omnibus, cuiusvis aevi, ad studia melius formanda utilissimum. Tiguri, 16. V. O.*  
 I. G. S. S. S. S. S.



**TIGURI**  
 APVD CHRISTOPHORVM FROSCHO-  
 VARVM, MENIS MARTIO, ANNO  
 M. D. LXXIIII.

**bidens —dentis, m.**

est, qui duos habet dentes. est etiam instrumentum rusticum ferreum, duobus velut dentibus una ex parte instructum, aptumque ad terram fodiendam.  
bipalium —i, n., est instrumentum palae instar latum, et ligneo oblongo manubrio praefixum ad terram versandam et fodiendam.  
falx —cis, f., est ferramentum incurvum ad varios usus in re rustica, quo segetes metuntur, quo faenum secatur; alio genere falcis arborescuntur.

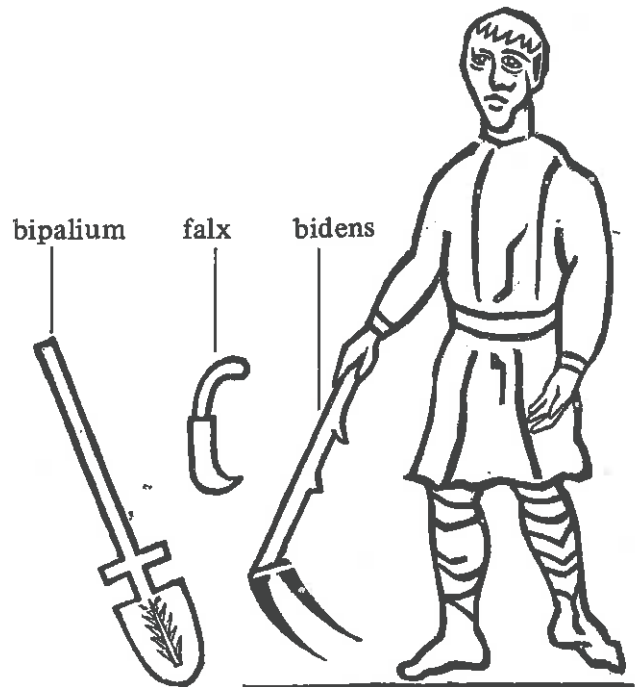

**bigae —arum, f. pl. (vel biga, —ae)**

a) bigae sunt duo equi iugo coniuncti.

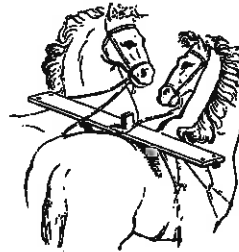

b) bigae sunt currus duobus equis iunctus; (*quadrigae*).



nummus bigatus est nummus antiquissimus, denarius argenteus, qui bigis ornatus est.



## bisellium —i, n.

bisellium erat sella plicabilis, latior, et duorum capax, quamvis unus tantum in ea sederet. accipitur pro sella splendida atque honesta, et honoris causa praeclaris viris concedi solita atque Augustalium in municipiis et coloniis propria, ut publice in ea sederent, in ludis, in theatro, in foro, in curia, ea ratione, qua Romanis magistratibus *sella curulis*, cui simillima erat.

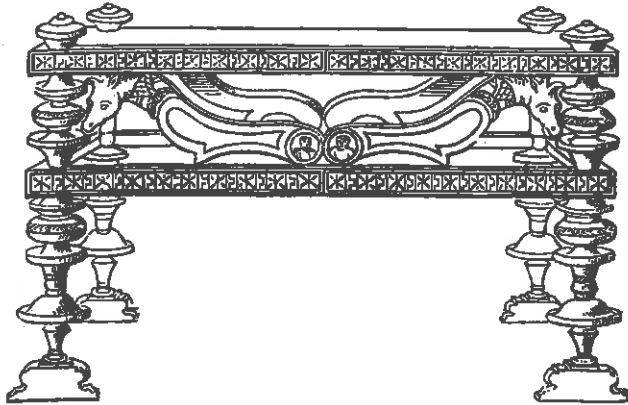

## bracae —arum, f. pl.

sunt vestis barbarorum propria, ut Persarum, Medorum, Sarmatarum, Gallorum, Germanorum, quae non femora solum, sed etiam crura, immo et ventrem contegit. a Romanis, sicut neque a Graecis, diu adhibita non erat. Posterioribus tamen temporibus etiam

ad Romanos transiit. Milites Romani, qui in Gallia et Germania vivebant, hanc vestem, bracas Gallicas, usurpare coeperunt frigoris vitandi causā, ut etiam in opere caelato columnae Marci Aurelii videmus.

Ovidius de barbaris quibusdam, Trist. 5, 7, 49: „pellibus et laxis arcent mala frigora bracis.“

## bractea —ae, f. (vel brattea)

bractea est lamina tenuis ex ligno, metallo, vel aliā materiā, quae alicui rei superinducitur. differt a laminā, quae crassior est et durior, et crusta appellatur. (*aurifex*).

(nummus) bracteatus est nummus bractea inductus.

\*\*bracteati in Medio Aevo nummi inaurati vocabantur.

Vergilius, Aen. 6, 209:

„... sic leni crepitabat brattea vento“  
de ramo aureo.

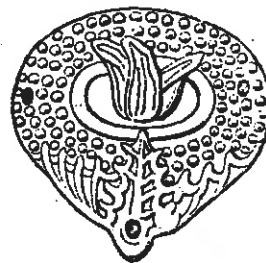

bractea, quae vestimentis assuebantur.





aurifex, malleo (*malleus*) laminam auream tractat

### bubulcus -i, m.

bubulcus est is, qui boves curat et agit. boves (*bos, bovis, boum, bubus*) iugo (*iugum*) plastro (*plastrum*) coniuncti sunt.



plastrum

bubulcus vel agitator

Cicero, de div. 1, 57 „bubulco praesto ad portam (fuit), (quaesivit) ex eo, quid esset in plastro.“  
proverbium: vide sub voce *clitellae*

### bucina -ae, f.

bucina est instrumentum recurvum, in quod insufflando sonos edimus. bucina signis dandis inservit.

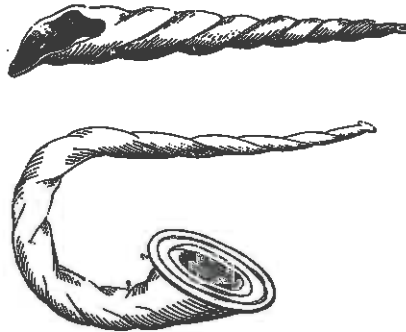

### bucinator -oris, m.

est qui bucinā canit ad signa danda. imago bucinatorem in navi signa canentem monstrat. bucinator etiam partes praecoris (*praeco*) agit.

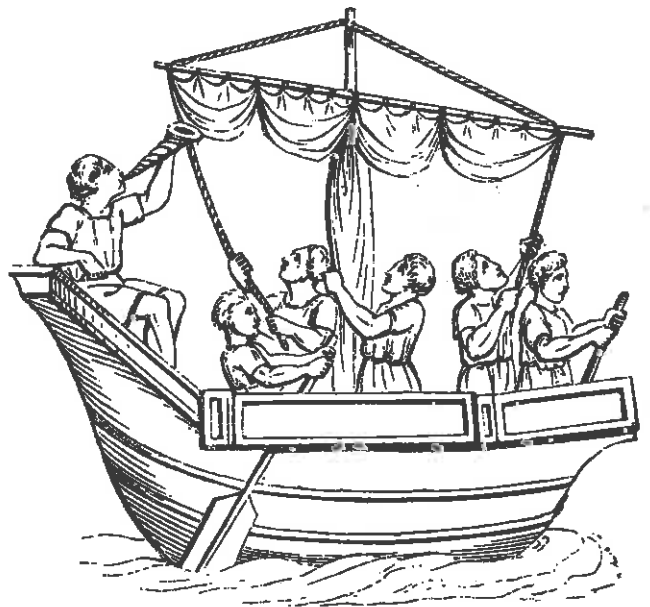

### bullā -ae, f.

a) est tumor globosus in aqua aut aliquo alio liquore excrescens, cum bullit aut spumam facit, et repente evanescens.

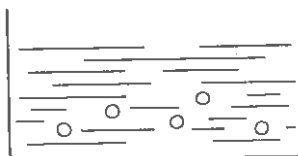

b) per similitudinem dicuntur bullae clavorum (*clavus*) capita, quibus ditiorum fores exornari solent, item quae cingulis (*cingulum*) et balteis (*balteus*) infigi.

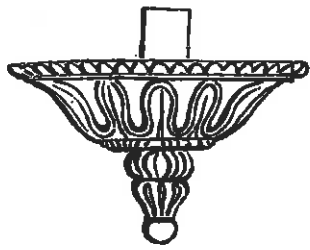

c) praecipue bullae aureae dicta est *insigne* quoddam, quod a pueris Romanis e collo ante pectus loro suspensum gestabatur in *signum* ingenuitatis et fortunae. tempore sumendae togae virilis bullam una cum toga praetexta deponebant et Laribus (Lares) donabant sicut puellae Veneri pupas (*pupa*) suas.

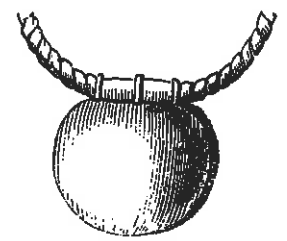
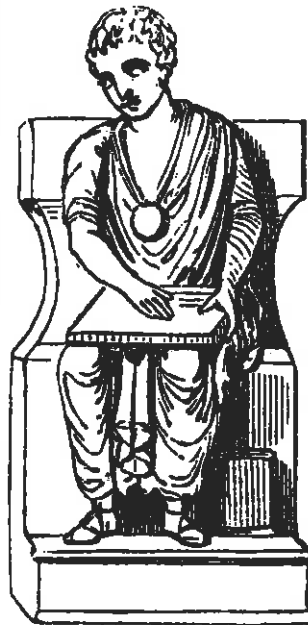

bullae aureae

puer bullatus

d) \*\* bulla est sigillum aureum pontificis Romani; ideoque etiam scripta bullis aureis sigillata „bullae“ nominabantur.

## Byzantium –i, n.

est urbs Thraciae ad Bosporum in promontorio (*promontorium*) inter sinum, qui „chrysoceras“ = „cornu aureum“ dicitur et Propontidem sita; post Constantinum Constantinopolis nominata est; hodie „Stambul“ appellata. hoc nomen ortum est ex verbis „eis ten polin“, quae Graeci accolae,

cum urbem adirent, usurpabant. Byzantium colonia Graecorum condita est anno a. Ch. n. 658 situ pulcherrimo ac tuto et commercii (*commercium*) quam maxime idoneo. memorabile est eius *templum* rotundum Stae. Sapientiae (Hagia Sophia) dedicatum, quod imagine illustratur.

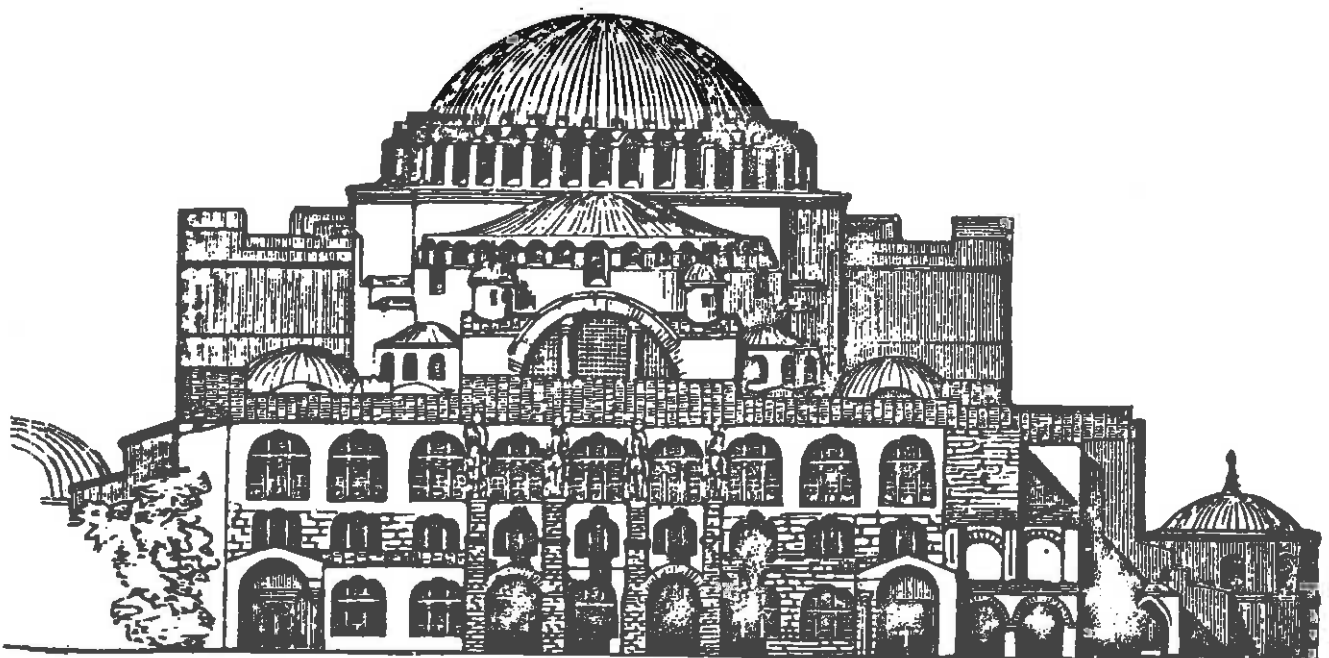

cādūceus –i, m. (aut –eum, –i, n.)

caduceus est virga Mercurii duobus serpentibus illigata.



Mercurius talaribus (*talaria*) caduceoque munitus

caducifer –i, m.

est qui caduceum (*caduceus*) gestat; epitheton Mercurii.

Ovidius, Met. 8, 617:

„venit Atlantiades (= Mercurius) positus caducifer alis.“

cadus –i, m.

cadus est vas condendo servandoque vino praecipue aptum.

cadi, ut dolia (*dolium*), ex fictili materia facti sunt.

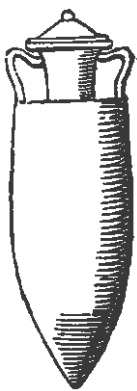

caelator –oris, m.

caelator imagines vasis aeneis insculpit. caelum est instrumentum caelatoris, quo vasa metallica imaginibus ornantur. signa metallo affixa emblemata (*emblema*) vocantur.

Quintilianus, 2, 21, 24:

„caelator caelum desiderat, et pictor penicilla.“ „caelum“ derivatur a verbo „caedere“, confer eius compositum incidere: incidere lignum, incisio = *xylographia*.

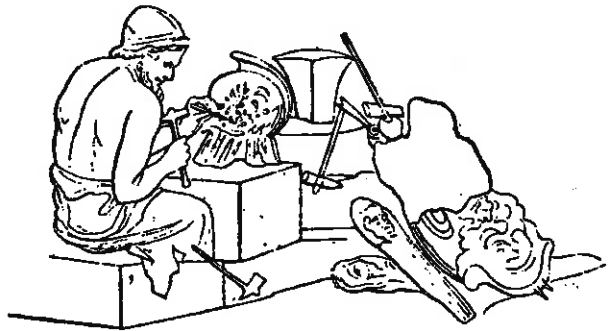

caelator opere caelato galeam ornat, manu sinistra caelum, dextrā malleum (*malleus*) tenens

calamister –tri, m. (vel calamistrum –i, n.)

est *acus* ferrea, qua capilli crispantur, intus cava instar calami harundinis (*harundo*).

Varro, LL. 5, 129 Müll.:

(calamistris) „calefactis in cinere capillus ornatur.“

calamistratus est qui capillos calamistro intortos habet.



calcar –āris, n.

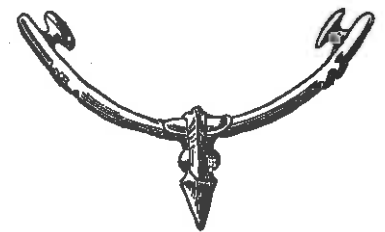
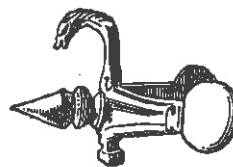

calcaria Romana

calcar est stimulus ferreus calci (calx) alligatus, quo equos pungimus et incitamus, ut docet

Isidorus, Orig. 20, 16, 6:

„calcaria dicta, quia in calce hominis ligantur, id est in pedis posterioris parte, ad stimulandos equos, quibus aut pugnandum est aut currendum.“

formula: concitare equum calcaribus. translate dicitur pro stimulo et incitamento.

Cicero, de orat. 3, 9, 36:

„in altero calcaribus, in altero frenis uti.“



id. ad Att. 6, 1, 12:  
 „alter (puerorum) frenis eget, alter calcaribus.“

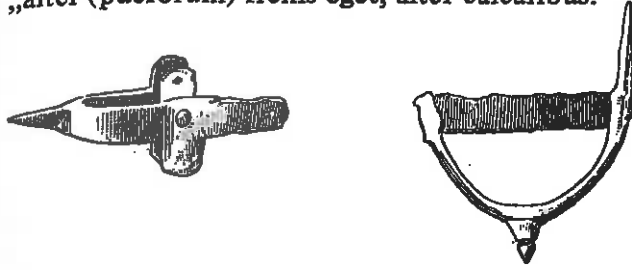

**calcator** —oris, m.

qui calcat, et speciatim qui calcat uvas.  
 (vide imaginem).  
calcatorium est locus in *cella* vinaria, in quo  
 uvae calcantur.

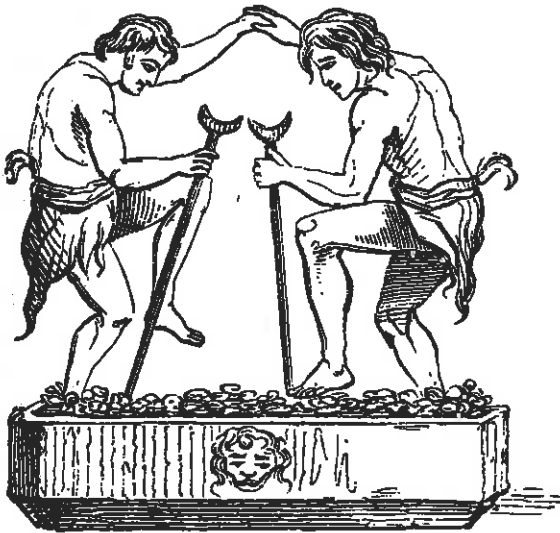

**calco** —as, —avi, —atum, —are

est aliquid calce et pede premere. calx (calcis)  
 f. est inferior posteriorque pars pedis.  
 calcantur uvae in torculario (Cato, RR. 1/2)  
 (*torculum*).

**calendarium** —i, n.

- a) Latini hoc nomine appellant librum, in quo faeneratores perscribebant nomina eorum, quibus pecuniam faenori dederant et pensionis solvendae quantitatem. quoniam Kalendis pecunia faenebris collocari solebat, et Kalendis itidem, vel Idibus eius usura solvi.
- b) \*\*posterioribus temporibus calendarium dictum est etiam liber, in quo anni, mensium ac dierum ac lunarium mutationum ratio per-

scribitur, vide specimen calendarii ruralis in illustratione apposita.

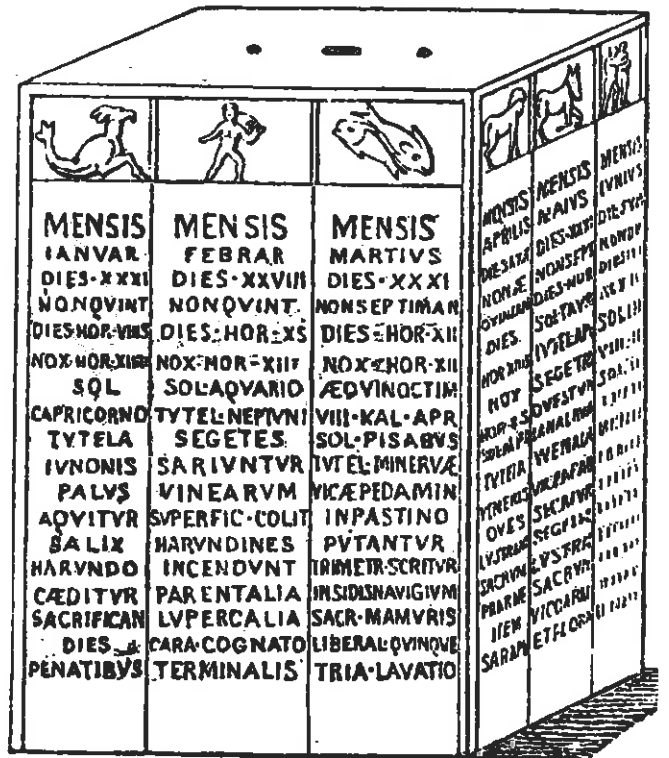

**caliga** —ae, f.

caliga est calceamentum militare, quo Romani milites gregarii utebantur, constans soleā coriacea, quae ferreis plerumque clavis (*clavus*) muniebatur habebatque ligamenta plura, quibus tum superiori pedis parti, tum imae tibiae circumdatis ligabatur; deminutivus: caligula. hinc cognomen C. Caesari filio Germanici et Agrippinae: Caligula.



**calix** —icis, m.

- a) vas ollae formam habens.
- b) vas coquendis cibis aptum.

c) item est poculum, ad calidam praecipue bibendam, ex terra vel aliquo metallo constans, nullis fere pedibus, mediocri altitudine, rotundum ac latum.



camera -ae, f.

est tectum incurvum in modum testudinis (*testudo*), tectum in modum crucis arcuatum sive ipsa tecti curvatura.

camera differt a fornice (*fornix*) in eo, quod camera significat totum tectum fornicatum,

fornix vero de singulis etiam camerae arcubus dicitur; quamquam hoc discrimen perpetuum non est.

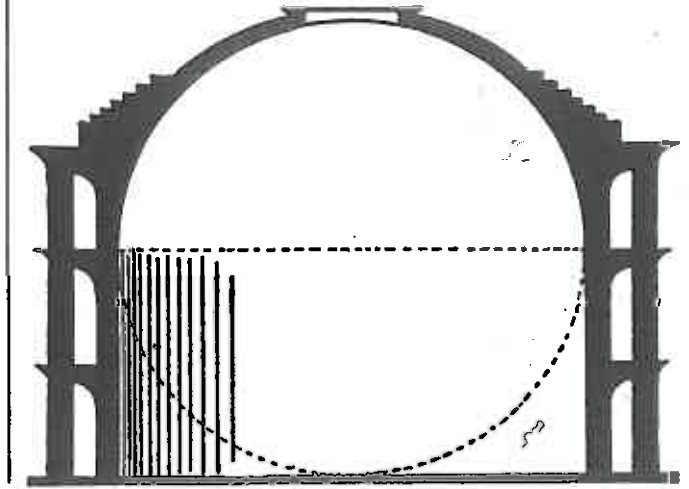

Campania -ae, f.

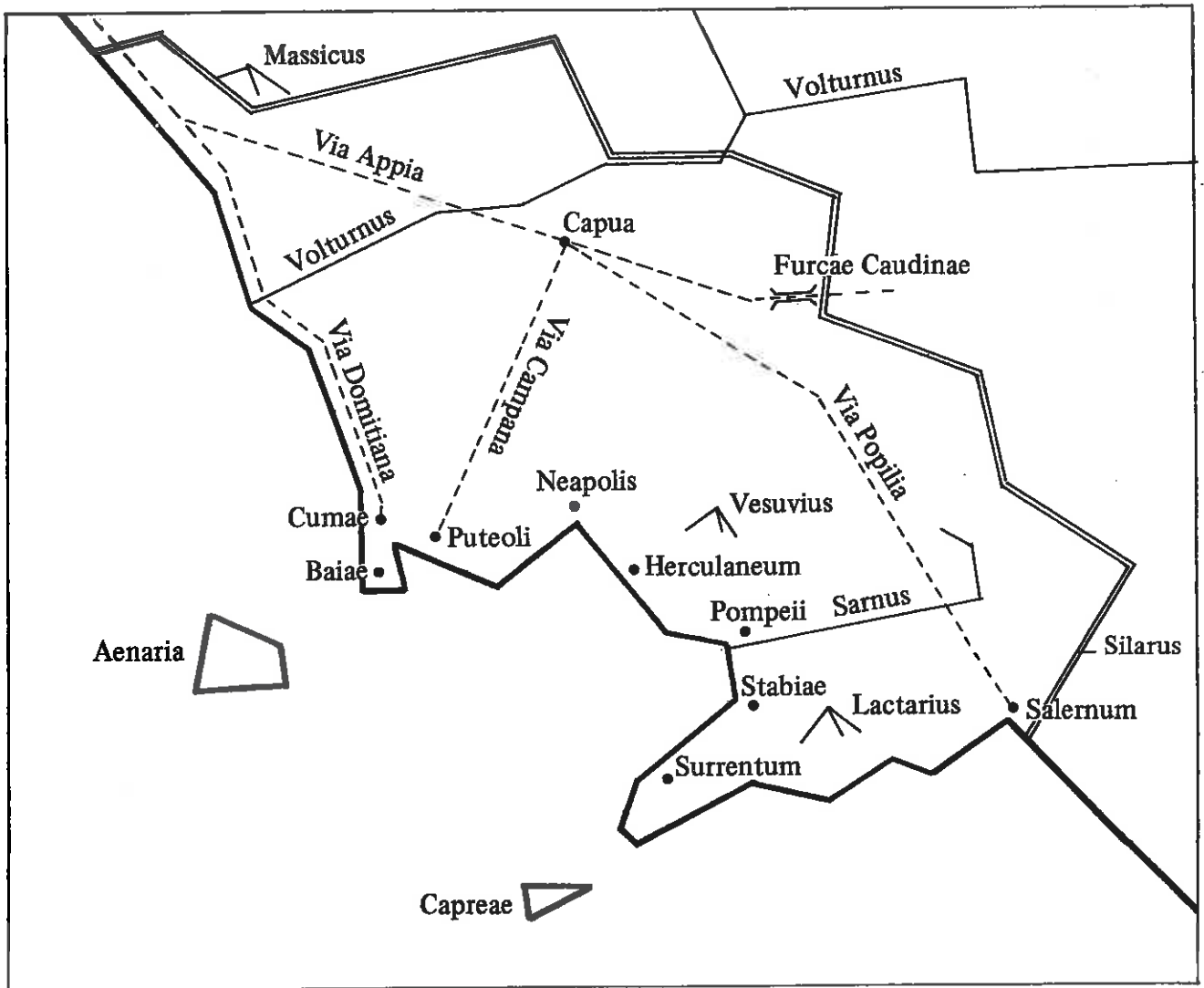

est regio Italiae australis, se protendens a Latio usque in Lucaniam, limites habens inter Latium, Samnium, Lucaniam et mare inferum, a monte Massico ad Silari ostium.

urbes et oppida:

Capua, caput Campaniae (adi. Campanus), Neapolis, Cumae, Baiae, Puteoli, Herculanum, Pompeii, Stabiae, Surrentum, Salernum et alia.

viae: Via Appia (Furcae Caudinae), Via Campana, Via Popilia, Via Domitiana.

montes: mons Massicus, Furcae Caudinae, mons Vesuvius, mons Lactarius.

flumina: Volturnus, Sarnus, Silarus.

### canalis –is, m.

canalis est *alveus*, tubus, fistula, meatus, plerumque arte factus ad irrigandos agros (irrigare).

Caesar, B. C. 2, 10:

„super lateres coria inducuntur, ne canalibus aqua immissa lateres diluere possit.“

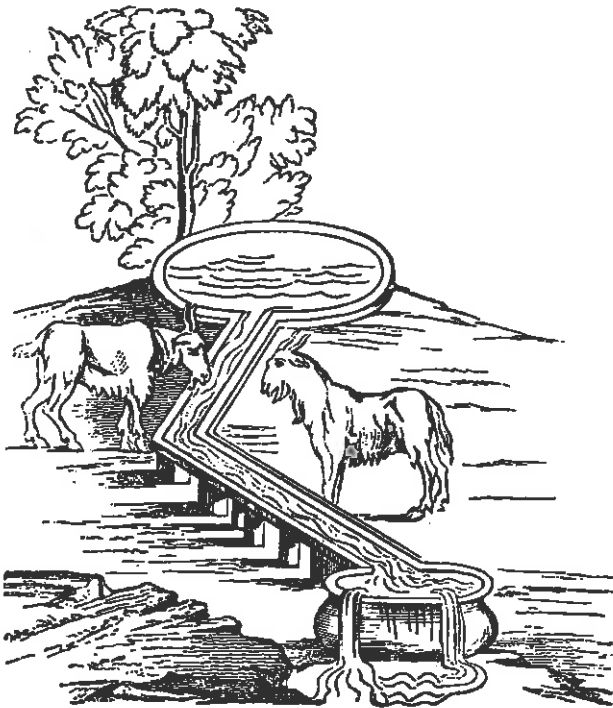

caprae e canali in agro bibentes

### cancelli –orum, m. pl.

cancelli sunt saeptum ex rectis et obliquis lignis aut ferramentis, modicoque intervallo distinctis

contextum, quo fenestrae, ianuae, scaenae, tribunalia muniri eorumque aditus praecludi solent.

Columella, R. R. 8, 17, 6:

„ravis, per quos exundat piscina, praefigantur aenei exiguis foraminibus cancelli, quibus impediatur fuga piscium.“



### candelabrum –i, n.

candelabrum est instrumentum, in quo candelae infiguntur. translate etiam candelabrum dicitur instrumentum illud, quod non candelas habet, sed oleum continet ad illuminanda cubicula.

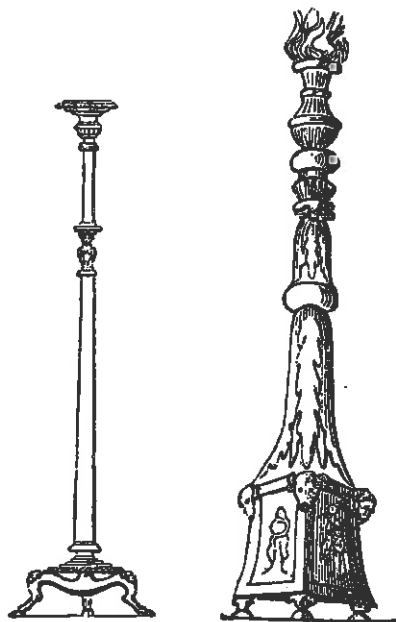

## canon —onis, m.

- a) canon (Gr.) proprie est *norma*, quae significat instrumentum fabrorum (faber).  
b) proprie apud Vitruvium, 10, 8, 2 est canon *arca* in machina hydraulica, in qua servatur aer et per canales (*canalis*) distribuitur.  
c) translate est regula constans et immutabilis, lex, ex. gr. canon architecturae, grammaticae, musicae (vide infra!).  
d) \*\*apud scriptores ecclesiasticos canon est lex, regula, decretum de fide, disciplinā et moribus a sacris conciliis sancitum, adi. canonicus.  
canonica ratio in re musica dicitur, quae longitudo et altitudines vocis emittitur. chorda iugo in ratas partes dividitur, videlicet 3:2 (quinta); 2:1 (octava); 4:3 (tertia). (*intervallum*)

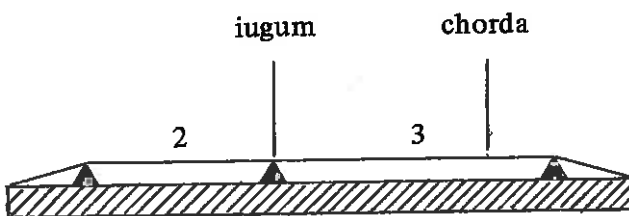

norma, canon, vel monochordum

## capistrum —i, n.

- a) est vinculum vimineum, coriaceum aut ex aliā materiā ad rem aliquam alligandam et coerendam, ex. gr. duas tibias tibicinis (*tibicen*).

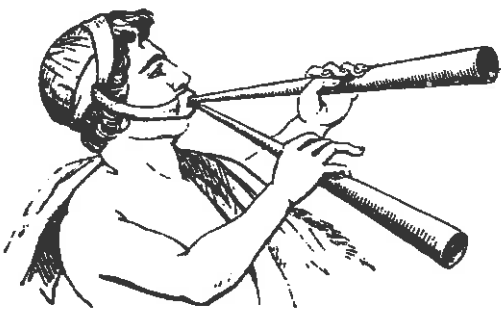

- b) capistrum est capitis vinculum, quod equis et iumentis adhiberi solet.

Ovidius Met. 10, 125:  
„... frenabas ora capistris.“

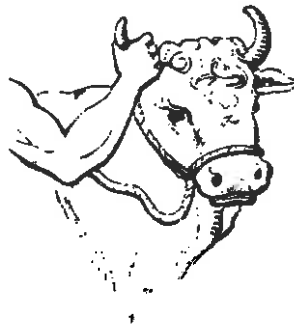

## capitulum —i, n.

est pars superior *columnae*.

Vitruvius, de architectura 4, 1, 1:  
„columnae Corinthiae, praeter capitula omnes symmetrias habent ut Ionicae, sed capitulorum altitudines efficiunt eas pro rata excelsiores et graciliores.“

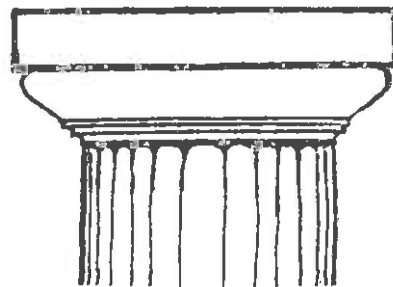

capitulum  
Doricum

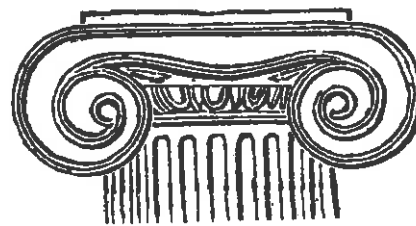

capitulum  
Ionicum

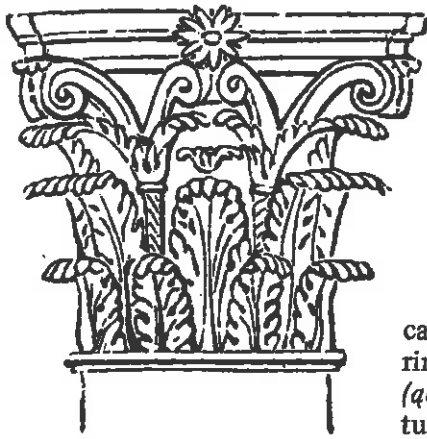

capitulum Co-  
rinthium acanthis  
(*acanthus*) orna-  
tum

### capsa —ae, f.

capsa est *arca*, cista, scrinium, ex ligno vel metallo aliquo, in quo praecipue volumina librorum et tabulae et litterae reponebantur. deminutivum: *capsula*, —ae, f., parva capsula ad libros et chartas reponendas. formula dicendi: „homo totus de capsula“ dicitur, qui summo-  
pere munditiis studet, et in eo totus est, ut exquisito cultu compositus ornatusque pareat. Seneca, *epist.* 115, 2:  
„nosti complures iuvenes, barba et coma nitidos, de capsula totos: nihil ab illis speraveris forte, nihil solidum.“

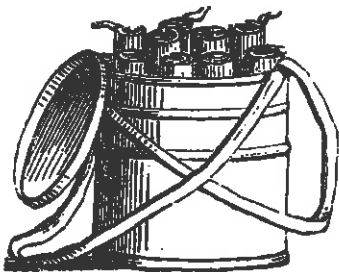
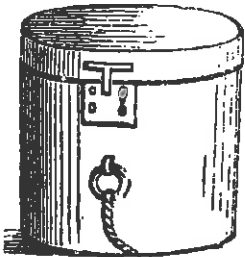

### carcer —ris, m.

est saeptum, cancelli, locus conclusus.  
a) usurpatur pro loco, in quo nocentes homines conclusi detinentur.

carcer

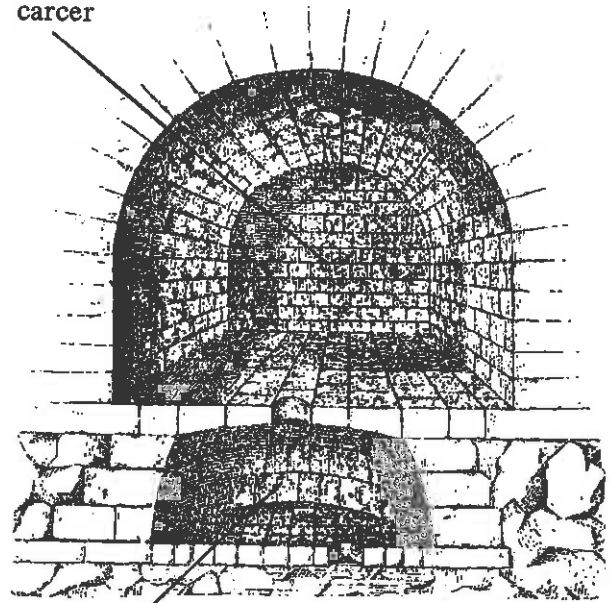

Tullianum

b) est saeptum, quo claudebantur equi et inde ad cursum demittebantur in publicis ludis (Varro, *LL.* 5, 153 Müll.).

### cardo —inis, m.

a) in machinationibus lignum aliquod in cavum seu foramen alterius immittitur, ut versari possit, *cardo* dicitur. speciatim *cardo* est fulcimentum illud, cui fores incumbunt et vertuntur. *cardines* apud veteres plerumque infixi erant in superiore et inferiore ostii parte, hoc est in superno et inferno limine. (*limen*)

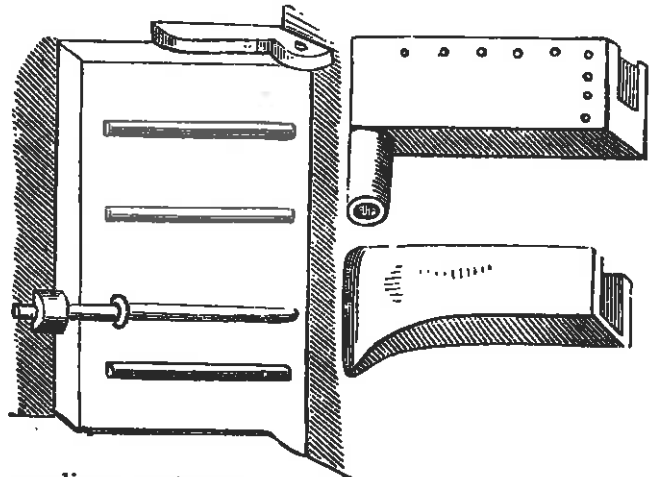

cardines portarum

b) in re astronomica et mathematica cardo est *axis caeli*, praecipue cardo dicitur *polus septentrionalis*, hinc in re agraria cardo est via, fossa, *limes* a meridie ad septentrionem ductus, quem admodum *decumanus* limes est, qui ab oriente ad occidentem. hae lineae etiam in castris et oppidis condendis ducuntur et vias principales castrorum vel oppidi definiunt. (*castra*)

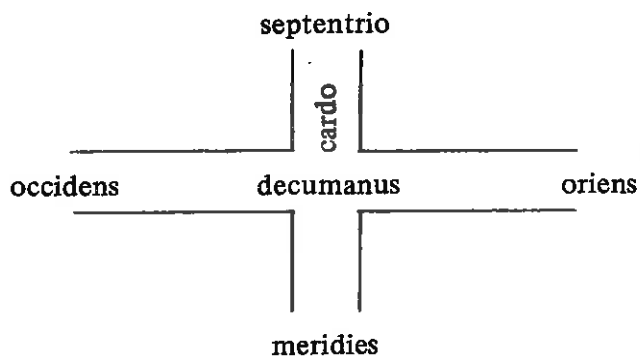

### carina —ae, f.

carina est ima pars navis, trabes ima, quae totius navis fundamentum est. apud poetas carina saepe dicitur pro nave (*pars pro toto*), ut tectum pro domo, caput pro homine et similia. (*puppis*)

### carpentum —i, n.

carpentum est genus vehiculi, cuius forma varia. carpento in itineribus extra urbem raro admodum sed Romae plurimum in itineribus urbis matronae usae sunt.

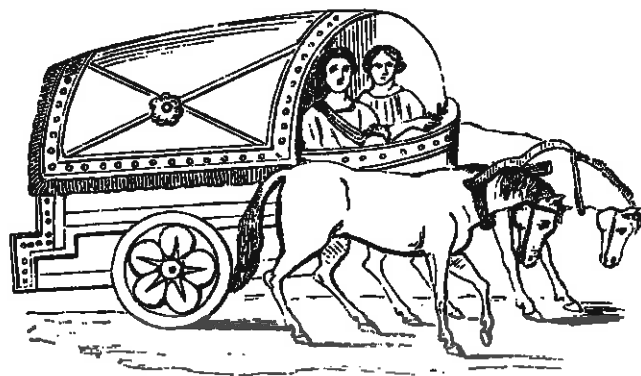

### Caryatides —um, f.

Caryatides sunt statucae virginum quae pro columnis tectum aedificii sustinent. (*Atlantes*). hae virgines Caryatides a loco *Caryae*, oppido in Peloponneso sito, nuncupatae, calathiscos (= corbes) capitibus portantes, *saltationem* in honorem Artemidis deae celebrabant.

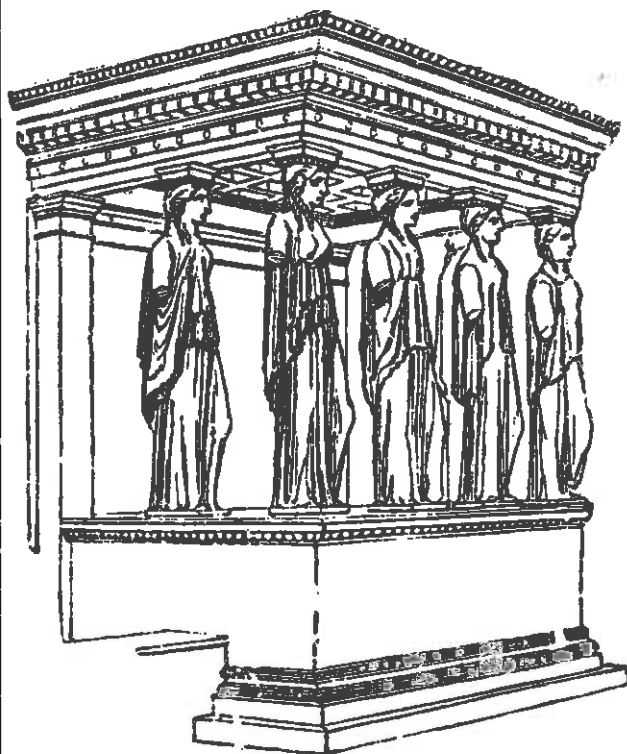

### casa —ae, f.

casa est domus vilis, tugurium, mapale, aedes deteriores et male constructae, cuiusmodi sunt, quas rustici et pauperes habitant.

Seneca, Ep. 90, 10:

„furcae utrimque suspensae fulciebant casam: spissatis ramalibus ac fronde congesta et in proclive disposita, decursus imbribus quamvis magnis erat. sub his tectis habitabant securi. *culmus* liberos textit: sub marmore atque auro servitus habitabat.“

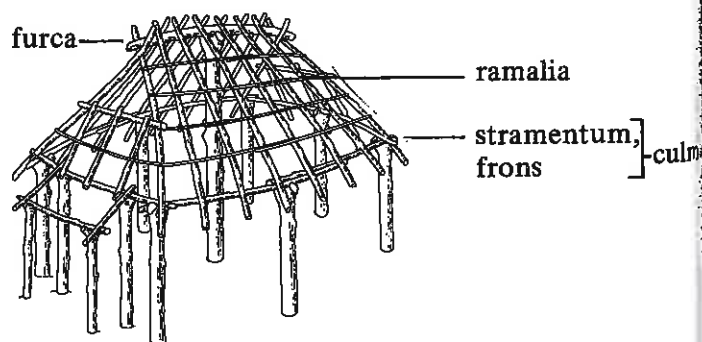

## castellum –i, n. deminutivum a „castrum“

- a) castellum est locus militari opere munitus exstructo aggere, vel muro cum fossa, quasi parvum castrum.  
b) translate castellum est locus operibus munitus ac tutus.  
c) castellum etiam nominatur receptaculum aquarum in aquaeductibus (*aquaeductus*), ex quo aqua ex communi ductu per fistulas in varia loca distribuitur: unde et „dividiculum“ dictum est; „aquam e castello ducere“.  
d) eodem nomine appellatur *labrum* amplum in summo rotae aquariae (*rota*), in quod influunt aqua ex modiolis (*modiolus*), cum ad summum elati invergi coeperint. (*Vitruvius*, 10, 4, 3)

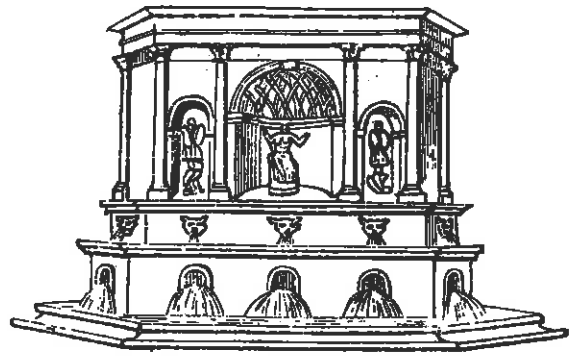

castellum aquarum

## Castor et Pollux

sunt Lacedaemonii, Iovis et Ladae, uxoris Tyndarei filii dicti, ex eodem ovo eodemque partu editi, fratres Helenae, quam a Theseo raptam et Aphidnae custoditam liberaverunt; Dioscuri, i. e. filii Iovis nominabantur. equorum tutores erant et saepe equis vehuntur, de quibus Cicero, Nat. Deor. 2, 2, 6: „apud Regillum, in nostra acie Castor et Pollux pugnare visi sunt.“  
Castor et Pollux alternā morte ab inferis redeunt seu alternatim vivunt.

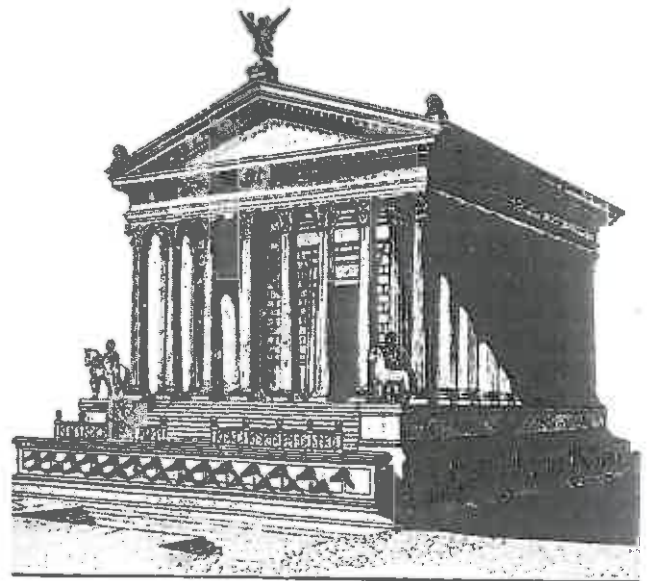

templum Castoris et Pollucis  
Romae aedificatum



sacrificium Dioscuris offertur

**castra** –orum, n. pl.

sunt locus, in quo exercitus cum in expeditione est, subinde consistit et vallo (vallum) fossaque munit, tentoria (tentorium) figit, quietem capit.  
 formulae: castra locare, castra movere.

e castris statis saepe oppida eiusdem ichnographiae fiebant, ut etiam in aliquot hodiernis oppidis cernitur, ex. gr. Xanten.  
 castra cardine et decumano in quattuor quadrantes dividebantur. (cardo, decumanus)

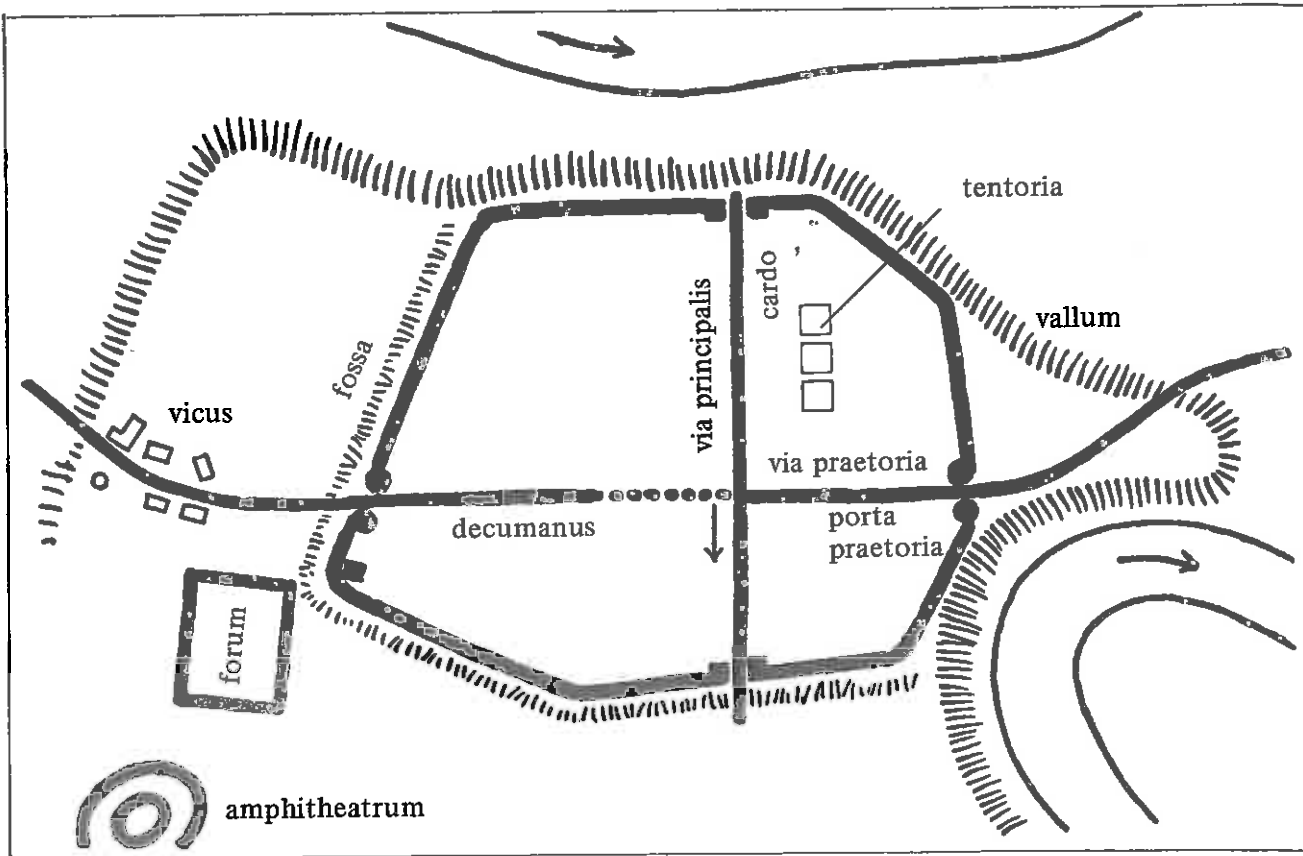

castra legionis Vindonissae sita

**\*catacumba** –ae, f.

catacumba est sepulcrum arcuatum, subterraneum, seu potius *fornix*, hominibus sepelien-

dis apta. temporibus persecutionum saepe primi Christiani his in locis latuerunt.

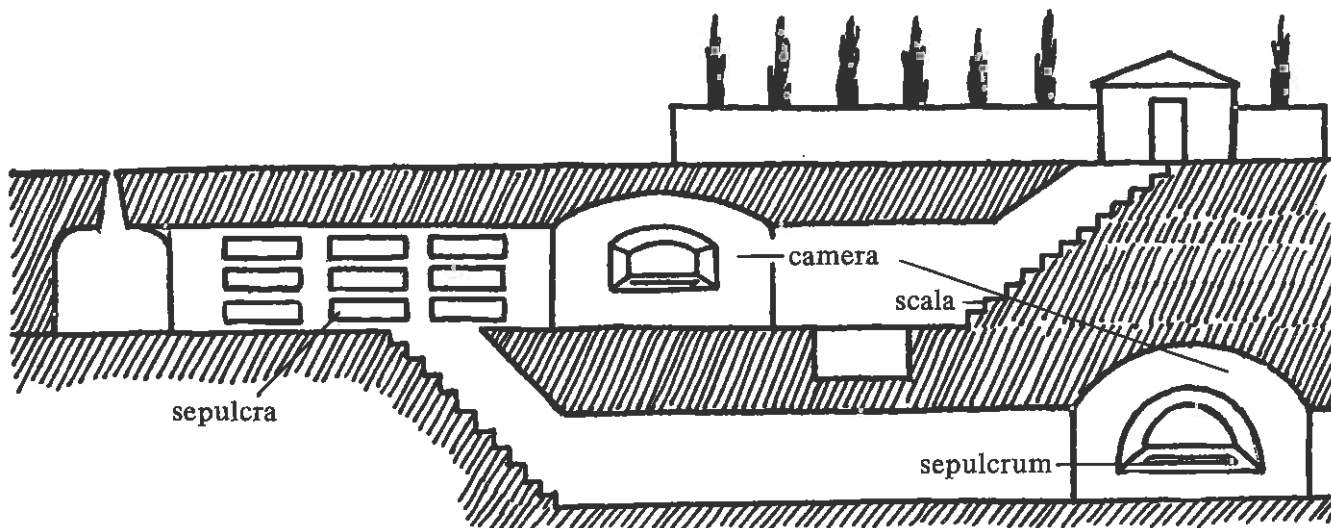



## catapulta —ae, f.

est genus machinae militaris, quā sagittae et tela magno impetu longoque spatio iaciuntur.

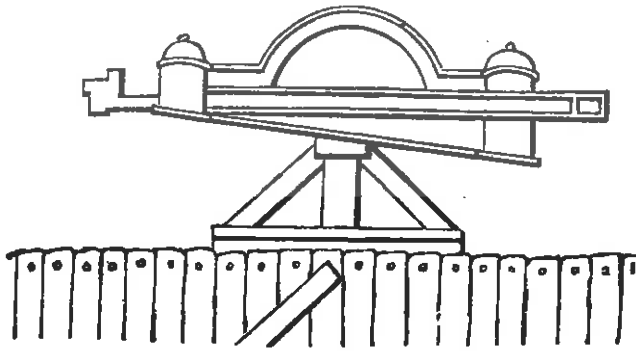

catapulta

## cataracta —ae, f./cataractes m.

significat praecipitem eruptionem et descensum:

a) cataracta est locus angustus, praeruptus, et praecipit in flumine, ubi aqua illisa et refracta magno impetu ruit, qualis est in Nilo eo loco, quae *Catadupa* ab incolis appellantur.

b) sunt etiam cataractae claustra in fluminibus arte facta ad aquarum impetum temperandum vel ad aquas colligendas.

c) item genus est militaris obicis in urbium portis, qui funibus aut catenis cum aperitur, in altum tollitur, et cum opus est, iis repente solutus, citissime decidens, momento temporis aditum claudit.

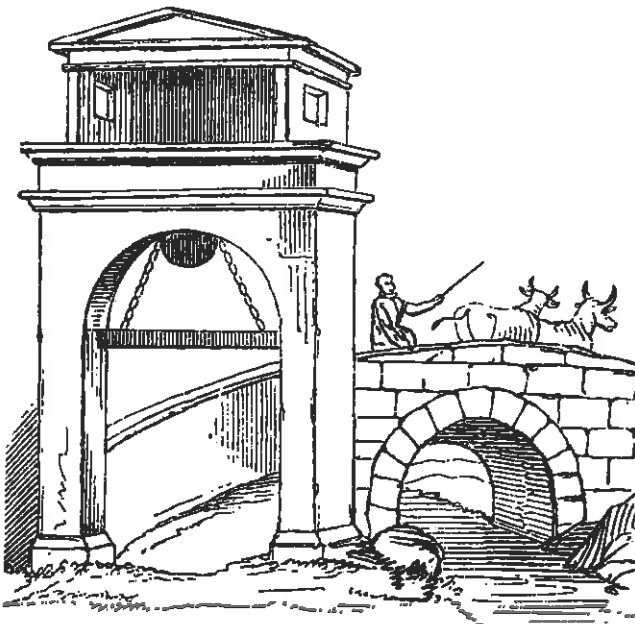

cataracta in aditu pontis, cui inferior pars deest

## catenarius —i, m.

est qui catenā ligatur, ut canis ad fores domūs custodiae causā.

imago repraesentat canem catenarium domūs Pompeianae cum inscriptione: cave canem!

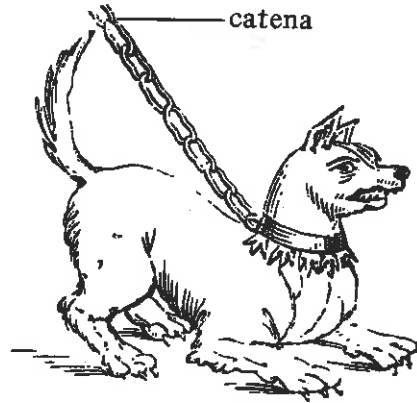

## cathedra —ae, f.

est Graeca vox, quae proprie significat sedile, sellam (*sella curulis*).

a) speciatim sumitur pro sella molliore et delicatior, qua utebantur mulieres et delicati etiam homines.



cathedra mulieris  
in vase Graeco

b) dicitur etiam pro sella magistrorum et professorum.

\*\*ponitur etiam pro sella et munere episcopali: ecclesia cathedralis est sedes episcopi.



cathedra professoris

### caupo —onis, m. (cōpo)

significat quemcumque mercatorem et institorem, praecipue esculentorum poculentorumque venditorem.

caupona, —ae, f.

est taberna, ubi mercatores res vendunt, et praecipue ubi caupones vinum et cibos vendunt ac peregrinos excipiunt, ut in figura nostra.

cauponari:

est cauponam exercere, e quo verbo verbum germanicum „kaufen“ derivatur.



lanius in laniēna: e pertica pendent caput vituli, perna aliaeque carnes

### caupona Pompeiana

haec imago Pompeiana interiorem partem cauponae monstrat. de tecto pendent tomacula et carnes in retibus e pertica:

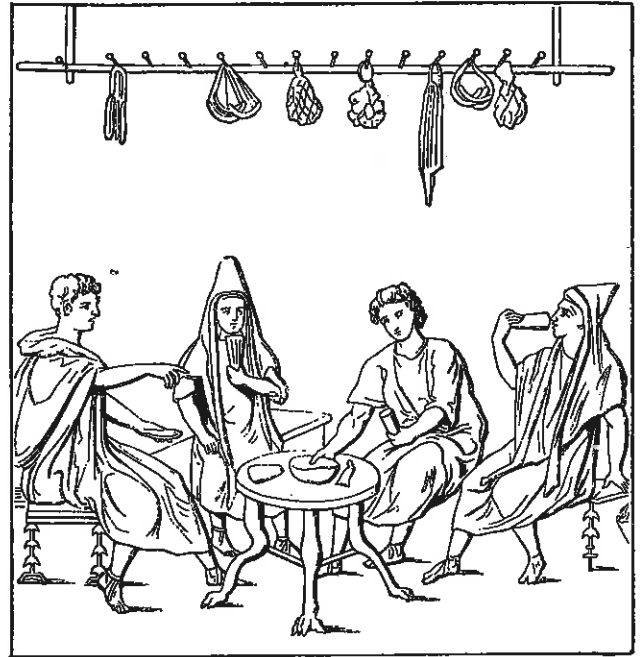

### cavea —ae, f.

a) cavea significat cavum et vacuum, quod multis constat circulis inter se divisus ac distinctis.

b) accipitur pro loco concluso aut saepto, in quo bestiae asservantur.

c) accipitur etiam pro quodam ianuae versatilis genere.

d) item de saepto (saeptum) ex lignis et spinis, quo tenerae arbores a pecudum iniuriis muniuntur.

e) praeterea dicitur de loco, in quo sedet populus in theatris (theatrum), quia concavus est et rotundus, tamquam cavea.

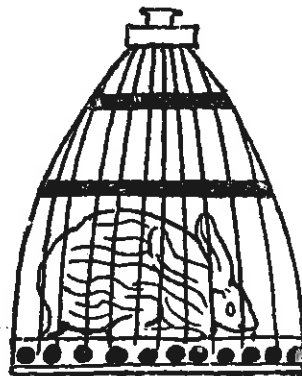

**cella** -ae, f.

cella est parva camera, semperque toti vel saltem ampliori aedificio opponitur.

a) in templis (*templum*) est pars sacratio et nobilior, in qua signa deorum stabant.

b) cella saepe est locus secretus in aedibus, in quo aliquid ad usum familiae reconditur.

c) in cella vinaria vinum servatur, in cella olearia oleum. sunt etiam cellae farinariae, pomariae, lignariae, caseariae etc.

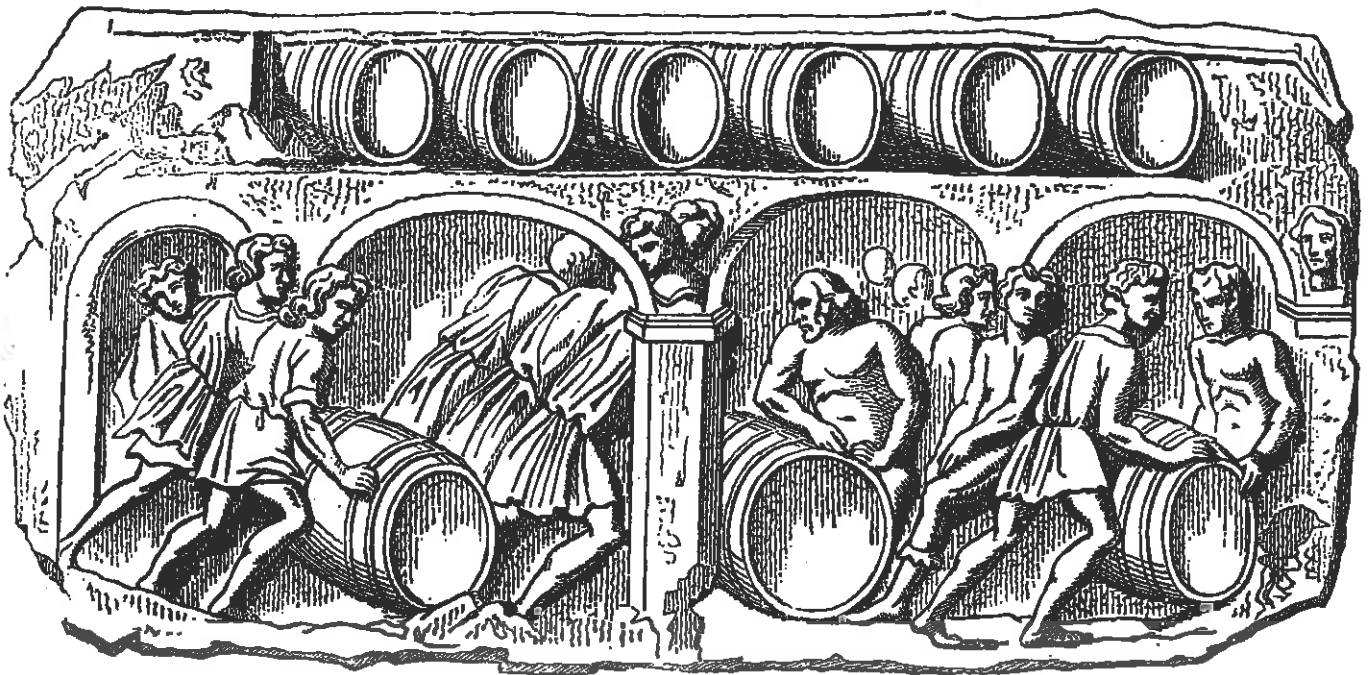

**cento** -onis, m.

a) cento est vestis ex variis pannis veteribus ac diversi coloris consuta, qua pauperum lecti sternuntur, ipsique pauperes ac rustici amictuntur.

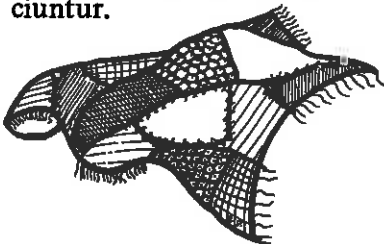

b) centones etiam dorso equorum mulorumque imponebantur, ne dorsum bestiae sellā tereretur.

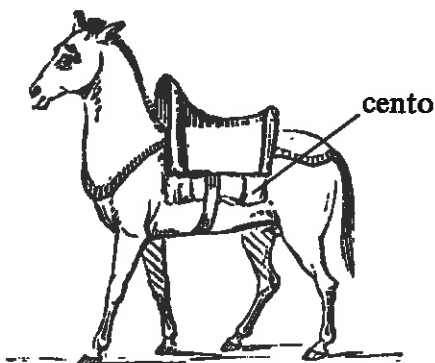

c) translate dicitur genus carminis ex variis alieni operis hinc inde decerptis versibus, et ad alia significanda traudctis consarcinatum, qualis est Cento Nuptialis ab Ausonio ex Vergilianis versibus compositus.

**centurio** -onis, m.

centurio est, qui centuriae praest. legio enim in decem cohortes divisa erat: hae in ordines ternos, quorum praefecti centuriones dicti sunt.



## cervical –alis, n.

est pulvinar quod vel ad mensam vel in cubiculo vel in lectica decumbentes cervici et capiti supponimus.

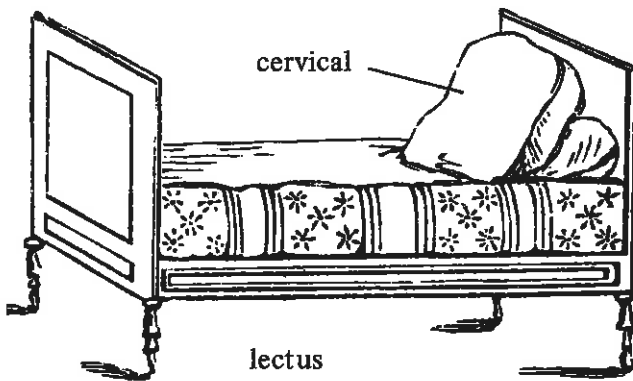

## Charon –ontis / –onis, m.

Charon est portitor inferorum, Erebi filius, quem animas mortuorum per tria Inferorum flumina, Acherontem, Stygem et Cocytum ad ripam adversam cymbā transvehere fabulantur.



## chimaera –ae, f.

est monstrum in Lyciā triplex, vertice nempe leonis, media parte caprae ignem vomentis, extrema in draconem desinens; a Typhone

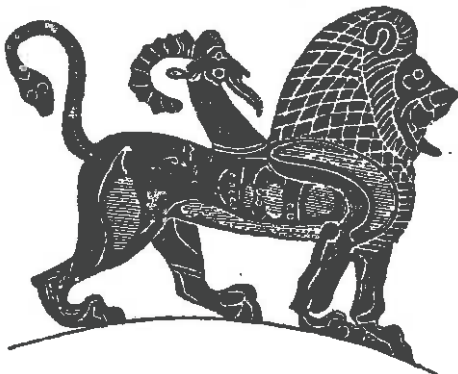

chimaera in vase Corinthio picta

genitum ex Echidna. ad monstrum interficiendum missus est Bellerophontes, qui Pegaso, equo alato insidens, illud interemit. chimaera saepe dicitur pro re, quae non exstat vel exstare non potest.

## ciborium –ii, n.

a) ciborium proprie est nomen herbae.

Porphyrio, in Hor. carm. 2, 7, 22:

„ciboria proprie sunt folia colocasiorum, in quorum similitudinem pocula facta eodem nomine appellantur.“

b) id quod poculum

Horatius, carm. 2, 7, 22/23:

„ciboria exple, funde capacibus unguenta de conchis.“

c) \*apud Ecclesiasticos est pars altaris tholi similis.

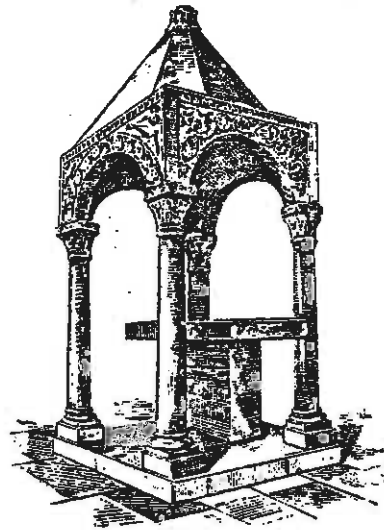

ciborium altaris

## cingulum –i, n.

cingulum est idem quod cinctus aut zona, a verbo cingo (cinxī, cinctum); cingulo succincta est tunica, ut expeditius se movere possit vir (homo alticinctus).



cingulum vel cestus

alticinctus

## circinus —i, m.

est instrumentum, quo circuli designantur. circini inventorem fuisse Daedalum narrat his verbis Ovidius, Met. 8, 247 ss:

„primus et ex uno duo ferrea bracchia nodo vinxit, ut aequali spatio distantibus illis, altera pars staret, pars altera duceret orbem.“  
(orbis)

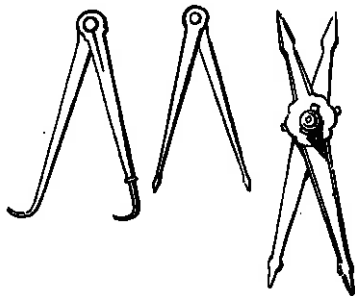

## circulator —oris, m.

a) circulator dicitur, qui merces de domo in domum vendit, et qui in omnibus auctionibus praesto est, ut merces, quae ibi forte vilio-

pretio venirent, coemeret, deinde cum lucro venditurus.

b) item circulator est homo circumforaneus, qui congregatā multitudinem in foro et per vicos varia medicamenta proponit, et praestigiiis, saltationibus, cantu aliisque huiusmodi ludicris plebem detinet et oblectat, lucris causa.  
(cf. imaginem.)

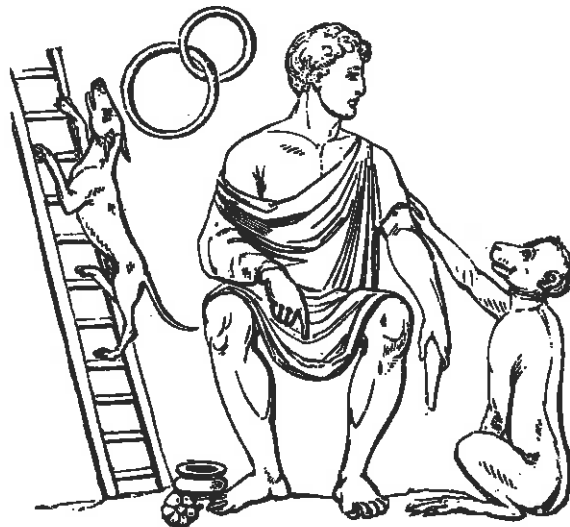

## circus —i, m.

a) circus est omnis in gyrum (*gyrus*) ambitus; deminutivus: circulus.

b) circus apud astronomos est orbis caelestibus signis circumscriptus.

c) generatim circus erat planities aperta; fere semper orbicularis, at figurā ellipticā, quae publicis praecipue ludis edendis, populorum conciliis habendis etc. inserviebat. Romae plures circi erant. Circus Maximus locus erat muris saeptus, in quo equi pugilesque exercebantur, sic dictus, quia orbicularis erat, longior

tamen quam latior, i. e. figurā ellipticā. Circus Maximus etiam extra ludorum tempora magnā semper populi frequentiam celebrabatur, cum eo convenire solerent ludicarum artium professores, circitores (= *circulatores*), physiognomi, somniorum coniectores, multique alii.

Iuvenalis, 10, 81:

(populus) „... nunc se continet atque duas tantum res anxius optat, panem et circenses ...“

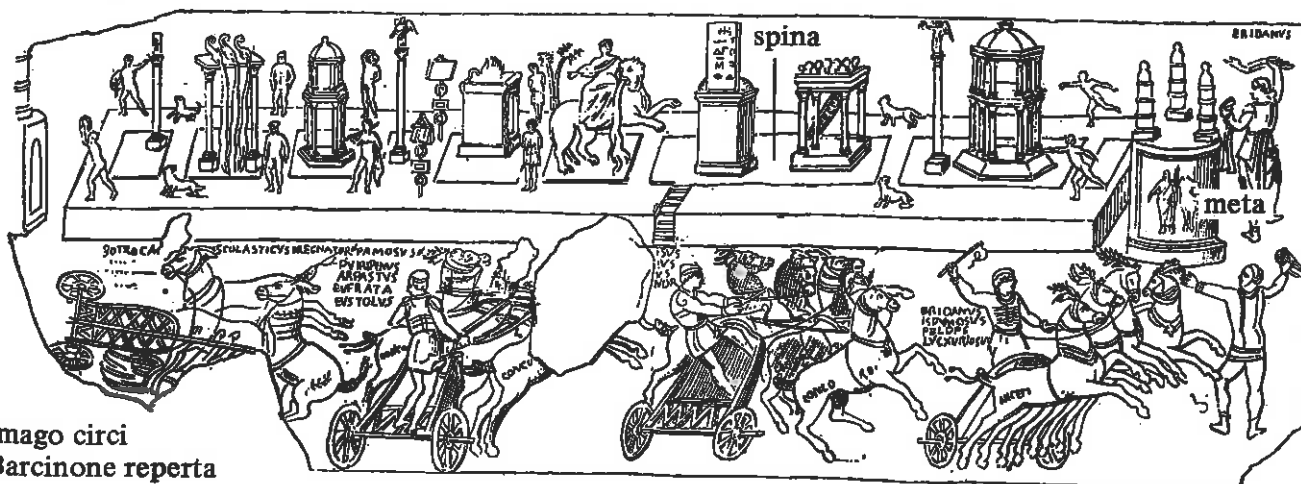

imago circi  
Barcinone reperta

## cirrus -i, m.

cirrus proprie est capillorum nodus in summo vertice (*vertex*) capitis, aut capillus naturā crispus seu contortus.

cirri etiam dicuntur fimbriae tenues in quibusdam vestibus, in extremitatibus earum dependentes.

\*\*propter similitudinem hodie etiam configuratio nubium „cirri“ nominatur.



gladiator cirro  
praeditus

## classarius -i, m.

classarii sunt milites, qui e navibus (*navis*) pugnant. etiam nautae et remiges inter classarios numerantur. *classis*, -is, f. est summa navium longarum.

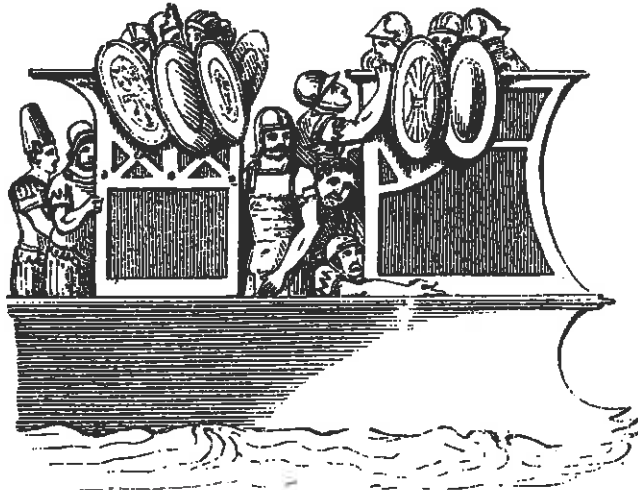

## cisterna -ae, f.

cisterna est receptaculum subterraneum aquae pluviae ex stillicidiis (*stillicidium*) collectae ad hominum usum, idque in tectis fiebat; contra „lacus“ ad pecorum usum fiebat sub divo.

Varro, R. R. 1, 11,2:

„si omnino aqua non est viva, cisternae faciundae sub tectis et lacus sub divo: ex altero loco ut homines, ex altero ut pecus uti possint.“

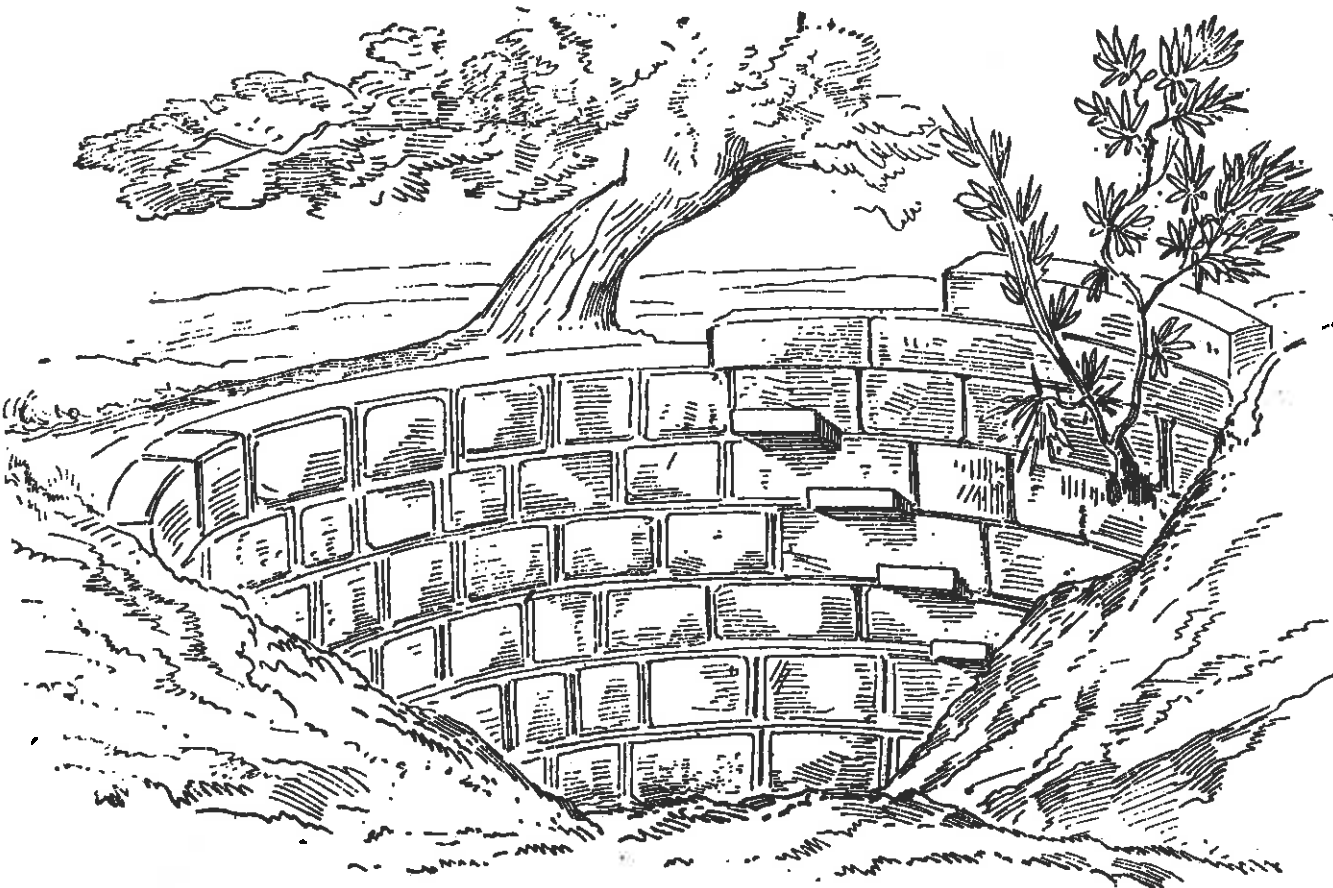

## claustrum -i, n.

est quidquid claudendo inservit, vectis, sera, repagulum, quo ianua aut quidpiam aliud clauditur.

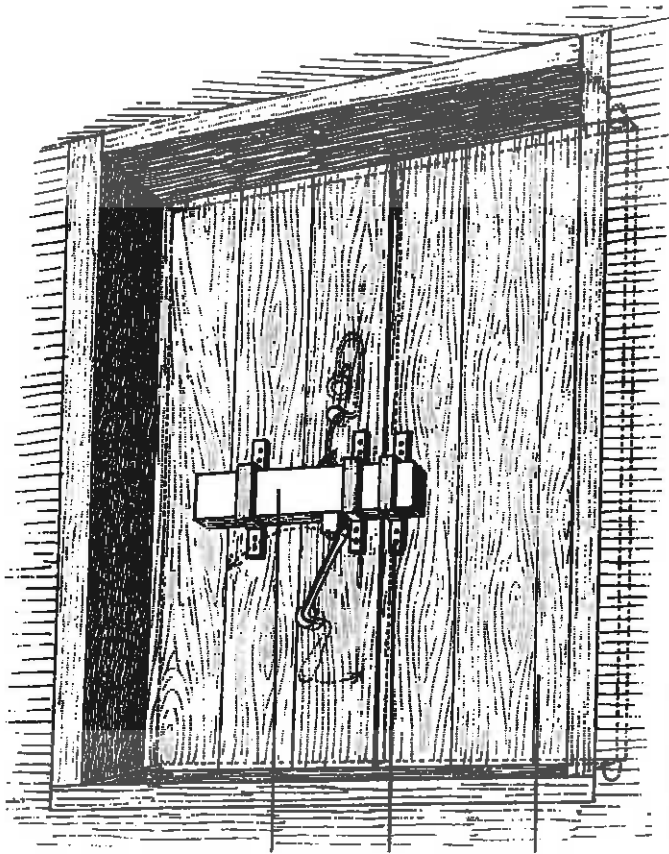

repagulum      sera      ianua

## clava -ae, f.

clava est ramus ex arbore recisus cum nodis, cui maximum pondus inest in parte inferiore. clava numeratur inter antiquissima et rudiora arma. Lucretius, 5, 966 s.:



claviger

„consectabantur silvestria saecula ferarum missilibus saxis et magno pondere clavae.“  
clava Herculi tribuitur, eoque telo plurima domuisse dicitur monstra: Hercules claviger.

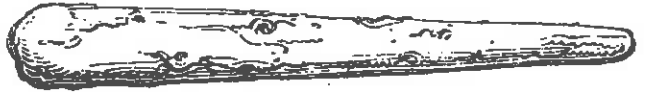

clava

## clavis -is, -ium, f.

est instrumentum ferreum, quo ostia (ostium), arcae (arca) et id genus multa clauduntur et aperiuntur.

Tibullus, 1, 6, 34:

... „tua si bona nescis  
servare, ah frustra clavis inest foribus.“



monumentum funebre (funus) Atticum in opere caelato sacerdotem cum clave templi representat

## clavus -i, m.

clavus est quidquid obtunditur vel percutitur, seu quidquid percutiendo infigitur.  
a) id quo aliquid figitur et alteri rei iungitur.



b) fustis, manubrium, quo gubernaculum navis torquetur.

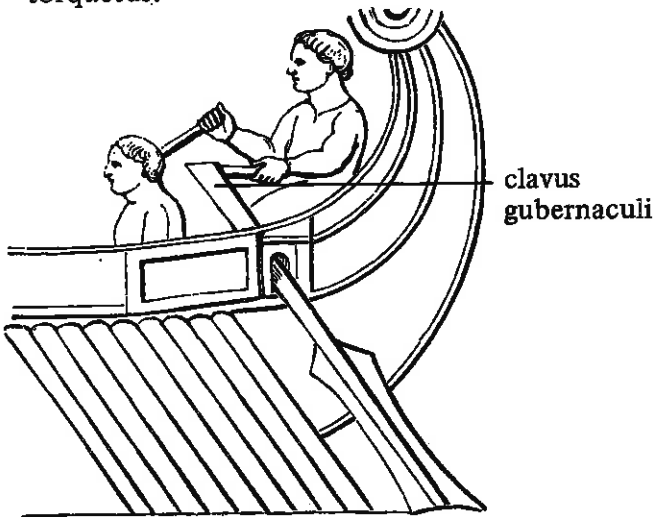

clavus gubernaculi

c) clavi in tunicis Romanorum erant segmenta, fere e purpura, ipsi tunicae assuta, ornatūs gratiā. latum clavum adhibebant senatores, angustum equites.

formulae: ad a) adigere clavum in arborem, figere aliquid clavis duplicibus, avellere clavum adactum.

mos fuit Romae dextro lateri aedis Iovis Capitolini, ex qua parte fuit Minervae templum, clavum quotannis idibus Septembribus figere, ideo singuli clavi erant indices numeri annorum.

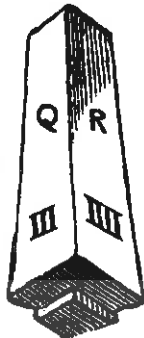

clavus annalis

## clipeus –i, m.

clipeus est scutum rotundum, quod milites (*miles Romanus*) sinistra manu gerebant tegendo ab ictibus corpori.

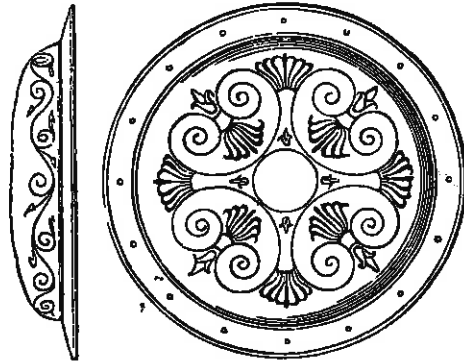

b) latiore sensu dicitur etiam clipeus discus ex aere, aut alia quapiam materia, in qua sculpebantur aut pingebantur deorum ac virorum magnorum imagines usque ad pectus representatae. clipeata imago est imago in clipeo depicta vel sculpta. (*Triton*)

## clitellae –arum, f. pl.

sunt *ephippia*, quae imponuntur dorsuariis iumentis, ad onera commodius gestanda.

formulae: clitellis apportare aliquid; clitellas asino imponere. proverbium: „bovi clitellas imponere“, i. e. onus alienum imponere alicui: Quintilianus, 5, 11, 21:

„non nostrum, inquit, onus bos clitellas (videns)“; non est officium meum clitellas portare.

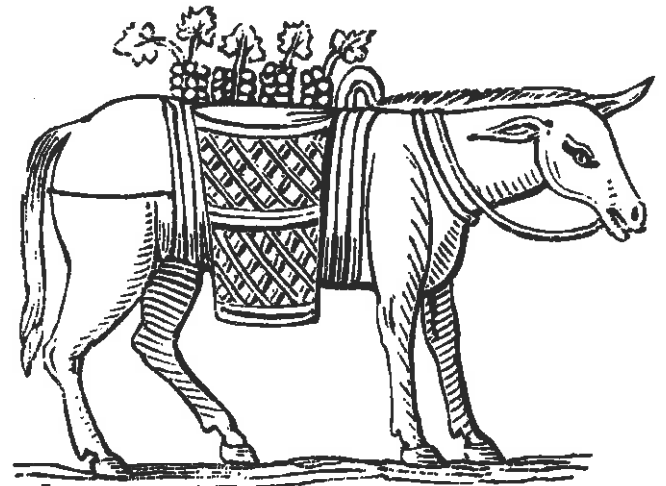

asinus clitellis onustus



## cloaca —ae, f.

est *cuniculus*, aquae ductus subterraneus, lateribus vel lapidibus structus, ad deducendas aquam imbrium sordesque urbis. imago exitum Cloacae Maximae, quae etiam hodie exstat, in ripa Tiberis fluminis monstrat.

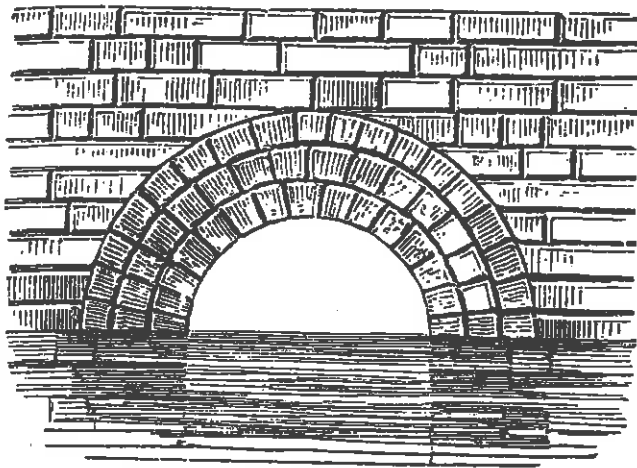

Cloaca Maxima in ripa Tiberis sita

## cochlea —ae, f.

cochlea est limax, animal notum, testā inclusum tortili et turbinatā:

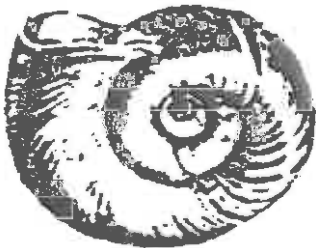

cochlea etiam nominatur porta versatilis, qua in ludis circensibus utebantur ad evitandas bestias feras, ut in hoc nummo describitur.



cochlea

cochlea est etiam machina haustoria ad aquam hauriendam et tollendam. est autem machina, cuius in medio rota est, quae dum a calcantibus (*calco*) versatur, machina intus cochleae instar detornata aquas exsorbet ex aquario saepto et retrorsus emittit.

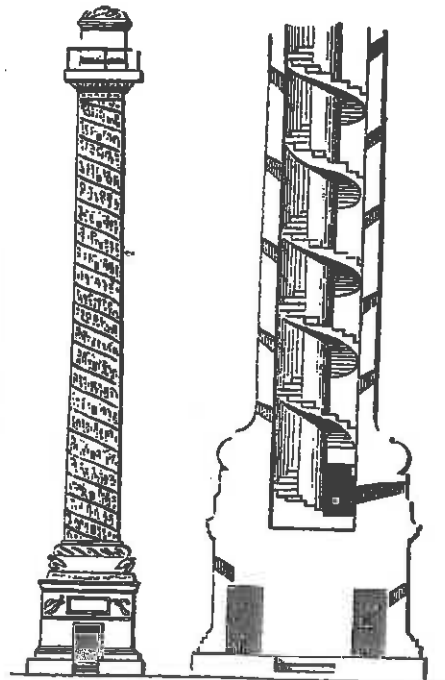

scala cochleata in interiore columna Traiana constructa

## cochlear —aris, n.

a) est ligula ex altera parte acuta, ex altera latior et cavata: illā extrahuntur ex sua *testa* cochleae (*cochlea*), hāc ova (*ovum*), alii eiusmodi liquidiores cibi.

b) est etiam *mensura* liquidorum, quarta pars cyathi (*cyathus*).

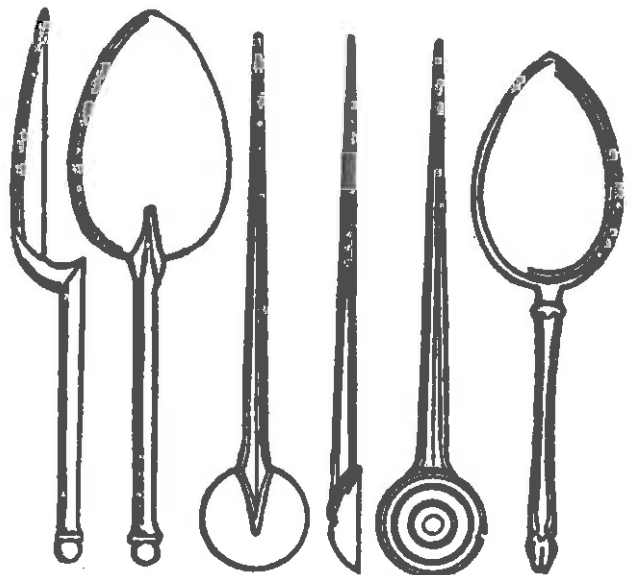

cochlearia Romana

## codicillus –i, m.

- a) est parvus caudex vel arboris truncus.  
b) codicilli (vel pugillares) sunt parvae tabellae scriptoriae, cerā illitae, in quibus stilo perscribitur. his usi sunt veteres ante chartae inventionem, cum per litteras aliquid alicui significandum erat. formula: exarare codicillos.

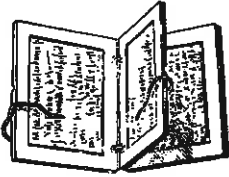

## \*coenobium –ii, n.

coenobium a Graeco koinos bios, significat vitae societatem et communitatem. accipitur

etiam pro loco, in quo simul vivunt coenobitae vel „fratres“, qui eodem simul loco sub iisdem legibus vivunt.

Isidorus, orig. 15, 4, 6:

„... est enim habitaculum plurimorum in commune viventium.“

coenobium etiam monasterium dicitur.

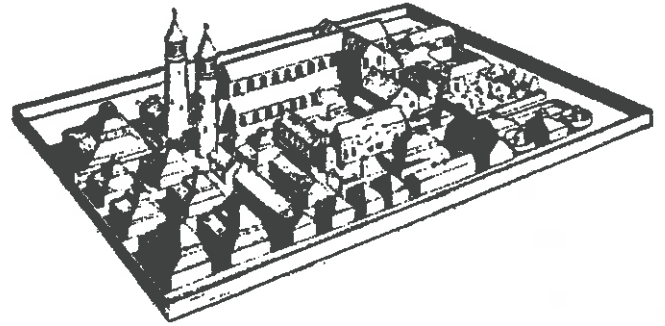

coenobium Sancti Galli, secundum formam idealem monasterii delineatum

## cognatio –onis, f.

cognatio est communis origo, coniunctio naturae et sanguinis (*affinitas*); gradūs cognationis sunt:

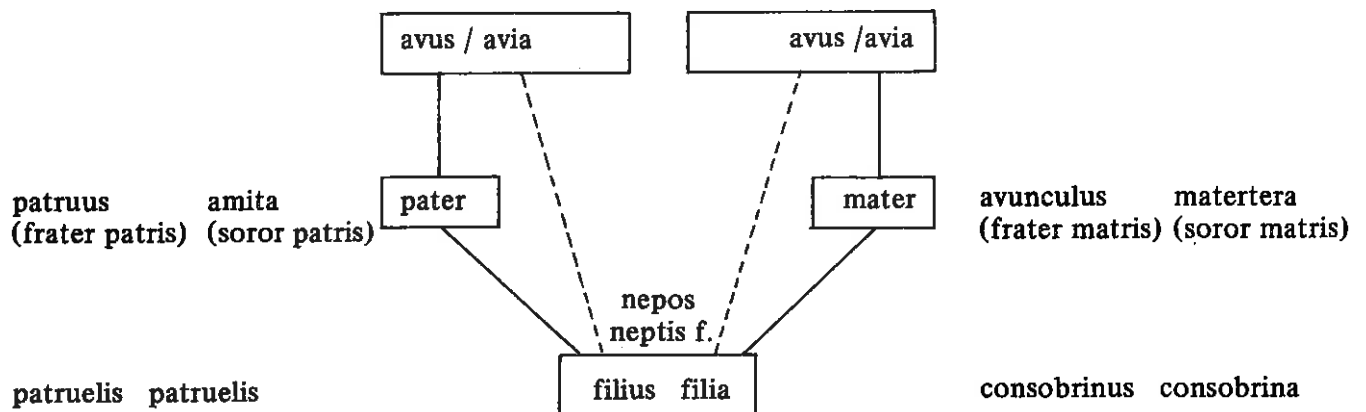

## cohors –tis, f.

- a) cohors est locus in villa, maceriis aut saepe circumdatus, in quo altilis aves custodiuntur et alia ad usum villae servantur.  
b) cohors est etiam hominum multitudo, quae

personam aliquam circumdat, hominum manus, comitatus. cohors praetoria circa imperatorem erat custodiae causā. et sub imperatoribus aulicorum quoque turba cohors dicta est (it. corte, fr. cour).

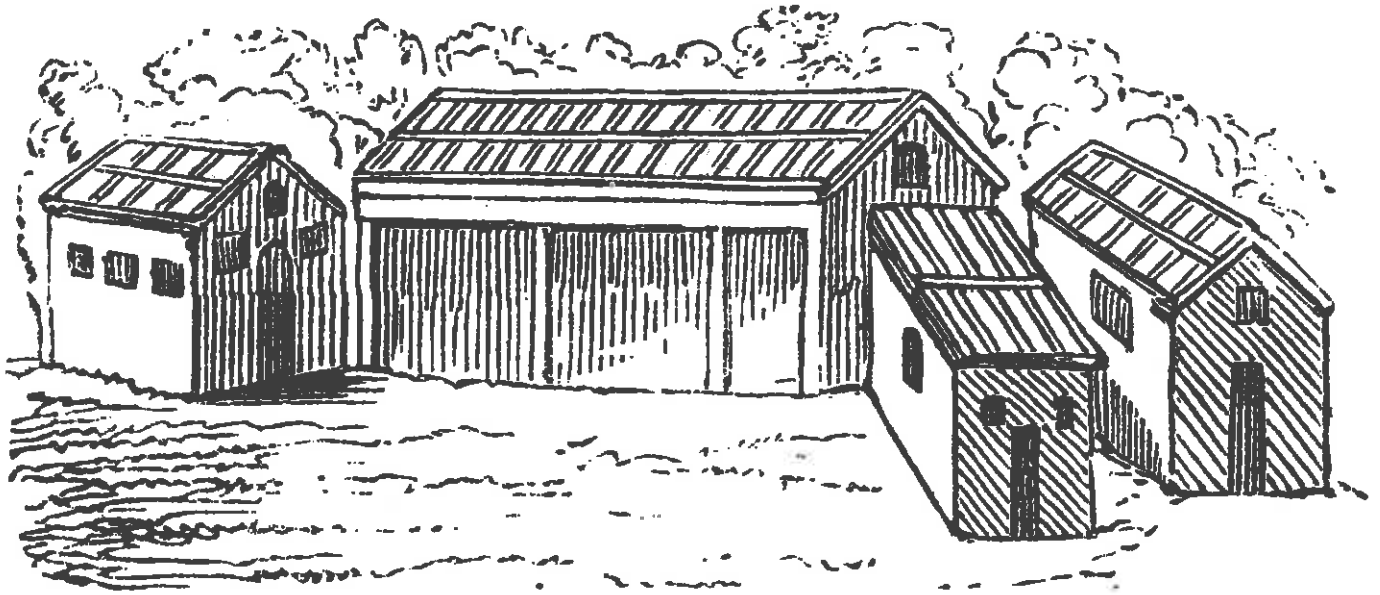

### colonia –ae, f.

colonia est pars civitatis aut sociorum deducta in aliquem locum, colendi et inhabitandi gratiā; itemque ipse locus.

coloniae civiles constabant ex civibus pauperibus, qui in aliquem locum agri colendi causā deducebantur; coloniae militares constabant ex militibus veteranis, qui in aliquem locum tamquam in laboris requiem deducebantur, simul ut adversus hostium incursiones praesidio essent.

coloni sunt cives unius civitatis in aliam deducti et eius iure utentes, a qua sunt propagati.

### colum –i, n.

colum est vas vimineum aut setaceum per quod vinum, lac, et alii liquores in aliud vas transmittuntur purgandi causā.

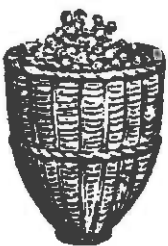

colum vimineum

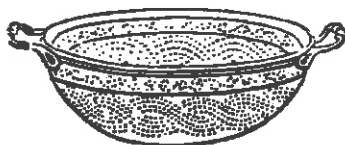

Plinius, H. N. 36, 173:

„per colum in proximam (transeat) pura aqua.“  
colum hīc appellat arenam, per quam aqua in cisternis purgatur.

### columbarium –i, n.

a) est locus, in quo habitant columbae.

b) a similitudine sic appellatur etiam cubile tigni et trabis in aedium parietibus.

c) item foramen rotundum in machina haustoria, per quod aqua in tympano (*tympanum*) concepta egreditur.

d) item locus in sepulcris, in quo olla cinerum reponebatur. (vide illustrationem.) (*sepulcrum*)

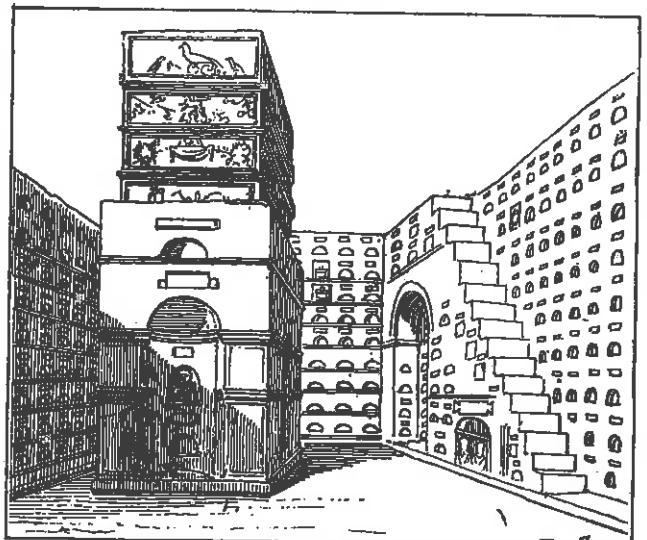

**colus** –us, f.

colus est instrumentum, in quo lanae pensum ponitur et fuso (*fusus*) fila deducuntur.

Ovidius, amor. 2, 6, 45:

„septima lux aderat, non exhibitura sequentem, et stabat vacuā iam tibi, *Parca*, colo.“

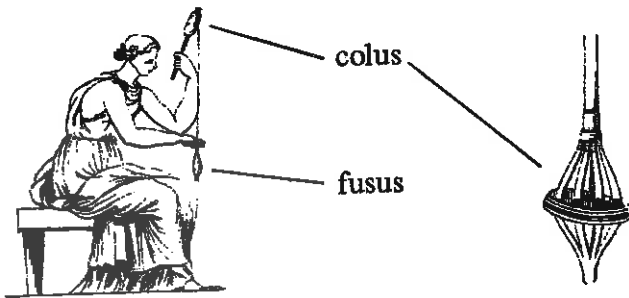

**comoedia** –ae, f.

comoedia est poema dramaticum, civium et vulgi actiones stilo populari imitans, non sine

salibus ac iocis, exitu laeto. (*pallium*)  
soccus est calceamentum comoediae personarum  
Horatus, A. P. 80  
„hunc socci cepere pedem ...“  
carmina socco digna sunt carmina iocosa et levia.



soccus

personae comoediae Terentii

**commutatio** –onis, f.

commutare est aliud pro alio substituere.

Cicero, Off. 1, 13, 39:

„Regulus de captivis commutandis Romam

missus (est).“

commutare vinum pro oleo, vel oleum pro vino;  
genus est commercii sine pecunia.



**De commutationibus rerum, & mercium sine nummis.**

imago sumpta ex Olai Magni opere

## compedes –um, f. pl.

compedes sunt vincula, quibus servorum, captorum aliorumve pedes vincuntur, e ligno aut e ferro; compedibus opponuntur „manicae“. „compeditus“ est servus compedibus victus.

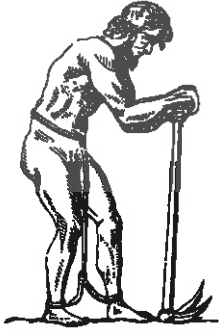

compeditus

## compendium –i, n.

a) est quidquid lucratur rem nostram servando. formulae: compendium facere, compendi facere. Plautus, *Pers.* 471:

„ego hodie compendi feci binos panes.“

b) latiore sensu generatim est lucrum ex deminutione operae, actionis, temporis ... et interdum est abbreviatio.

compendium viae, quod saepius compendium absolute dicitur, est via brevior.

formulae: compendio ducere aliquem = breviora via ducere aliquem; viā compendiarīā ire.

## compitum –i, n.

est locus, ubi plures viae competunt, hoc est confluunt, sive *bivium* illud sit, sive *trivium*, sive *quadrivium*.

adi. compitalis, a quo compitalia –ium, n. pl. sunt dies attributi Laribus Compitalibus. celebrabantur hiemis tempore non multo post Saturnalia. non tamen habebant diem certum, sed concipiebantur quotannis a praetore.

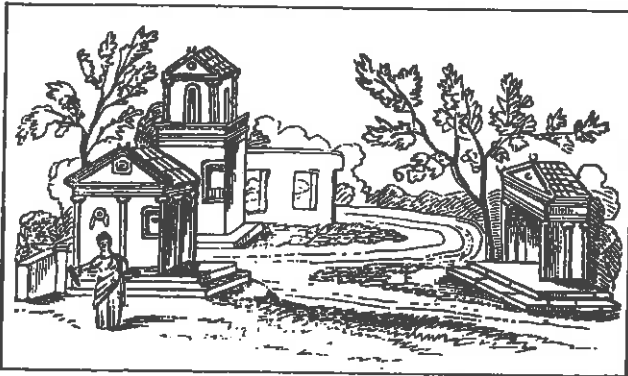

arae in compito erectae

## concordia –ae, f.

est unanimitas et consensus, eique opponitur discordia, ut apud Sallustium, *Iug.* 10: „concordiā res parvae crescunt, discordiā maximae dilabuntur.“

## congiarium –i, n.

a) ad congium (*congius*) pertinens.

b) vas congiarium: quod congium capit.

c) congiarium est donum, quod antiquitus in Romanā re publica distribuebatur in populum, et erant tot congii vini aut olei aut salis, etc.

Livius, 25, 2:

„Ludi Romani magnifice facti et congii olei in vicos singulos dati.“



donator congiarii in suggesto sedens tesseras congiarii distribuit

## congius –i, m.

est mensura liquidorum continens sextarios sex, heminas autem duodecim. erat autem pars octava *amphorae*, et vino aut aqua plenus pendebat libras decem. in hac imagine congium praebente P. X. significat „pondo decem“, h. e. libras decem continens.

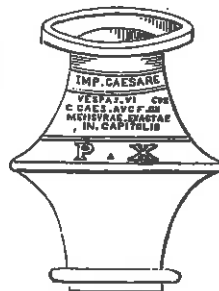

## consecratio —onis, f.

dicebatur imperatorum defunctorum in deos relatio, quod primum in Augusto factum est. fiebat autem exstructo rogo (*rogus*) aromatibus

farto immissoque igne; quo accenso *aquila* emittebatur, quam dicebant animam demortui ad deos evolantis. (*apotheosis*)

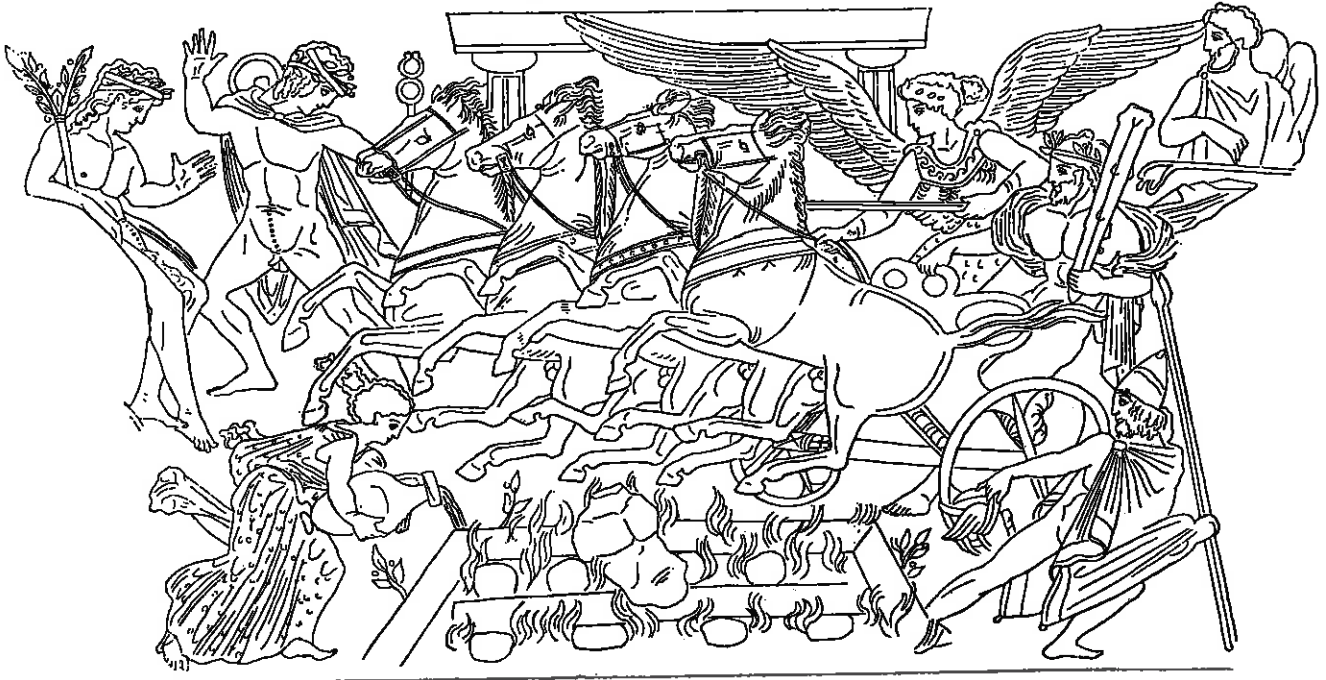

exemplar mythicum huius consecrationis erat consecratio Herculis, qui a rogo inflammato sublatus in *quadriga* ab Amore Mercurioque ducta in caelum ascendit, ut in hac imagine vasis Graeci quarti saeculi a. Ch. n. videtur

## constratum —i, n.

constratum ptc. consterno —stravi, —stratum, 3. c. sunt tabulae, aut aliud quidpiam constratum.

**Petronius, Satyr. 100:**

„... ut super constratum navis occuparem secretissimum locum.“

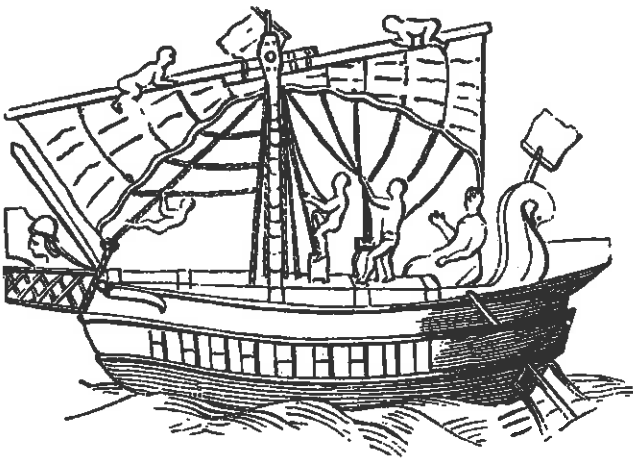

constratum navis

**Livius, 30, 10:**

„levia navigia sub constratis pontium per intervalla excurrebant.“



constratum pontis

## consul —is, m.

consul fuit summus apud Romanos post exactos reges magistratus, a Iunio Bruto introductus. duo viri fuere aequali potestate, quos penes omnis rei publicae tum belli tum pacis administratio ac ius fuit. insignia consulatus (*insigne*) fuere eadem quae regum, *trabea*, *toga praetexta*,

scipio eburneus, sella curulis et duodecim lictores (lictor) cuique, qui totidem fasces virgarum cum securibus praeferebant.

consulis insignia

1 sella curulis

2 fascis

3 scipio eburneus (sceptrum)

4 calcei

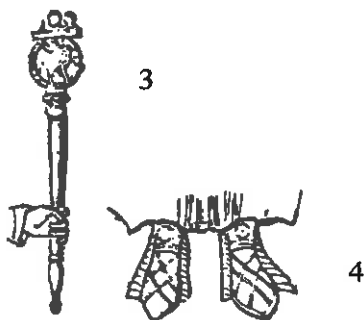
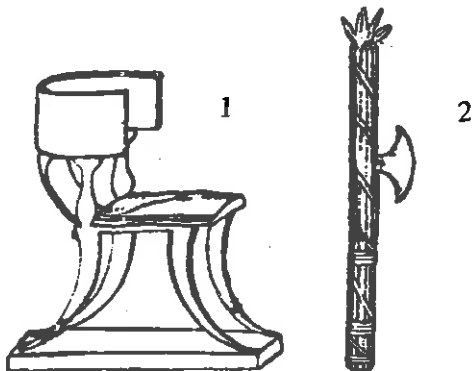

### contignatio —onis, f.

contignatio est tignorum seu trabium series et contextus, ut in aedibus, quae membra superiora domūs sustinet.

Bellum Alex, 1:

„incendio tuta est Alexandria, quod sine contignatione sunt aedificia.“

contignatio opus est tignarii (tignarius).

### contus —i, m.

contus est longa sudes, pertica, hasta longior et robusta. etiam est instrumentum propellendis navibus aptum.

Vergilius, Aen. 6, 302:

„ipse ratem conto subigit ...“

percontari est conto vel perticā aquarum altitudinem explorare, quod in nave facit proreta

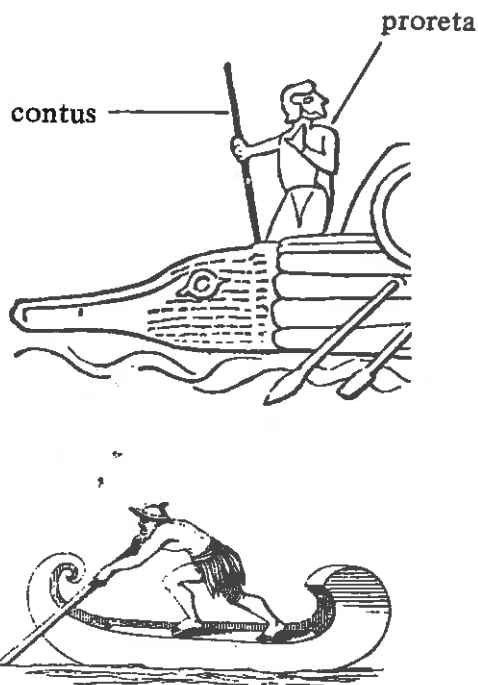

### convivium —ii, n.

convivium est cena inter multos celebrata.

Cicero, de sen. 13, 45:

„bene enim maiores accubitionem epularem amicorum, quia vitae coniunctionem haberet, convivium nominaverunt.“

pocillator est puer, qui poculum convivis implet et praebet, dapifer, qui dapes adfert.

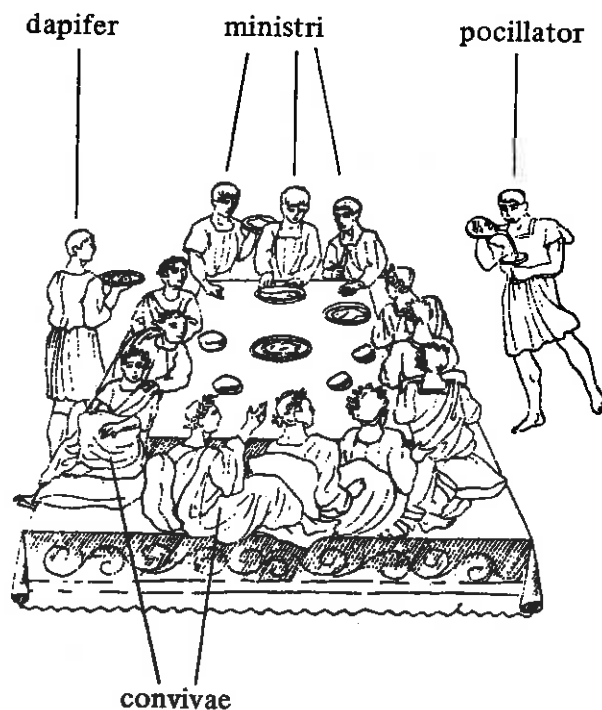

## copula –ae, f.

a) est vinculum, nexus, quo plura simul ligantur et connectuntur. specialiter dictum est de vinculo, quo alligantur canes venatici.

b) translate: amicus est copula virorum dissimilium; e. gr. Atticus Ciceronem et Hortensium tamquam copula vinculo amicitiae constrictos habebat.

c) speciatim dicitur de verborum nexu et compositione.

d) \*\*in logica: copula est nexus verbalis inter subiectum et praedicatum; plerumque copula verbum auxiliare est.

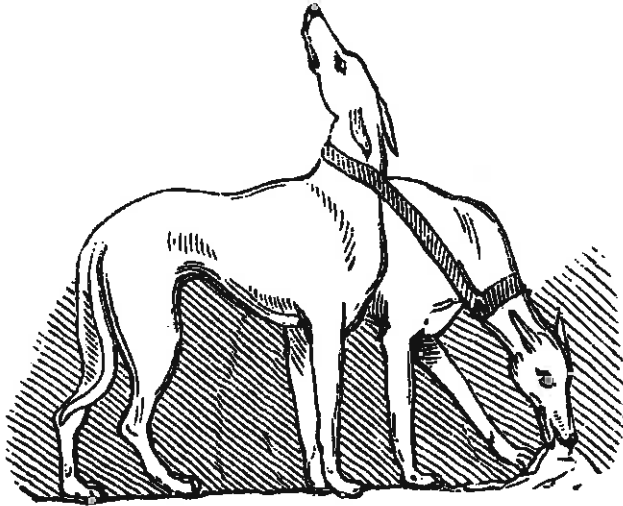

canes venatici copula iuncti

## corbis –is, f./m.

corbis est vas e vimine, ad usus rusticos, praesertim colligendorum fructuum. corbis etiam *mensura* est. per corbem mensuram vini facere est metiri modum vini ex modo uvae, cuius mensura per corbem definiri solet.

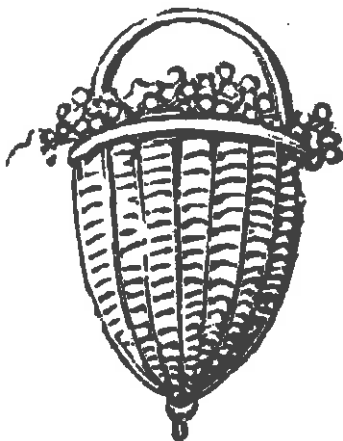

## corbita –ae, f.

est navis oneraria duorum mälorum (*mälus*, –i), quorum unus corbem (*corbis*) gestat, e quä cursus *navis* observabatur. a vocabulo „corbita“ derivatur fr. gall. „corvette“.

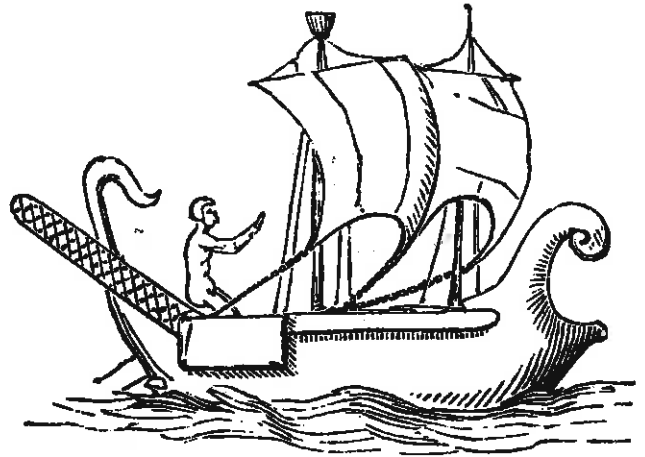

## cornicen –cinis, m.

est is, qui cornū (*instrumenta musica*) signa canit; confer: *tibicen*, qui tibiā canit, *fidicen*, qui fidibus canit. f.: *tibicina*, *fidicina*.



cornicen  
in *arcu*  
Constantini  
fictus



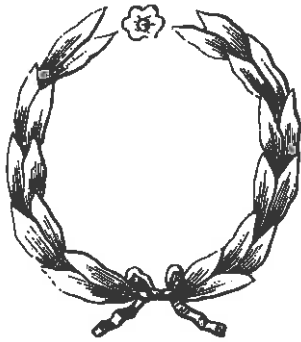

corona triumphalis

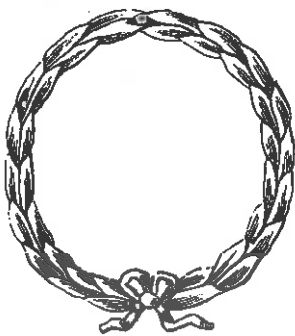

corona ovalis



corona obsidionalis

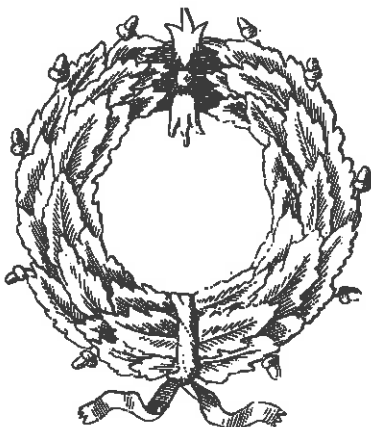

corona civica

corona est ornamentum circulare capitis, sertum, strophium. coronae, quae virtutis ergo dabantur, diversorum generum fuerunt, scilicet corona vallaris, c. castrensis, c. civica, c. muralis, c. navalis, c. obsidionalis, c. triumphalis, de quibus Gellius, 5, 6:

„triumphales coronae sunt aureae, quae imperatoribus ob honorem triumphii mittuntur ... obsidionalis est, quam ii, qui liberati obsidione sunt, dant ei duci, qui liberavit ... civica corona appellatur, quam civis civi, a quo in proelio servatus est, testem vitae salutisque perceptae dat ... muralis, est corona, qua donatur ab imperatore, qui primus murum subiit inque oppidum hostium per vim ascendit; idcirco quasi muri pinnis decorata est. castrensis est corona, qua donatur imperatori eum, qui primus hostium castra pugnans introivit; ea corona insigne valli habet. navalis est, qua donari solet, maritimo proelio qui primus in hostium navem vi armatus transsiluit; ea quasi navium rostris insignita est. et muralis autem et castrensis et navalis fieri ex auro solent. ovalis corona murtea est: ea utebantur imperatores, qui ovantes urbem introibant. ovandi ac non triumphandi causa est, cum aut bella non rite indicta neque cum iusto hoste gesta sunt, aut hostium nomen humile et non idoneum est ut servorum piratarumque, aut deditione repente facta ‚impulverea‘, ut dici solet, ‚incruentaque victoria obvenit‘.“

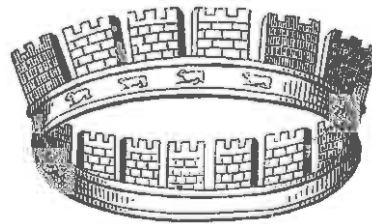

corona muralis

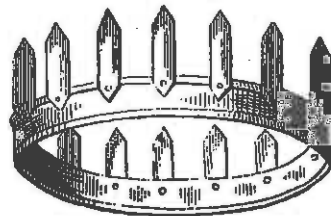

corona vallaris

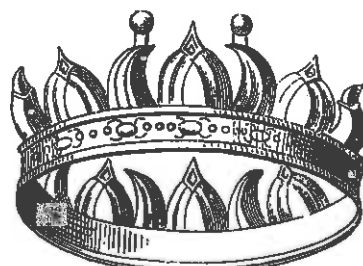

corona navalis

# corpus humanum

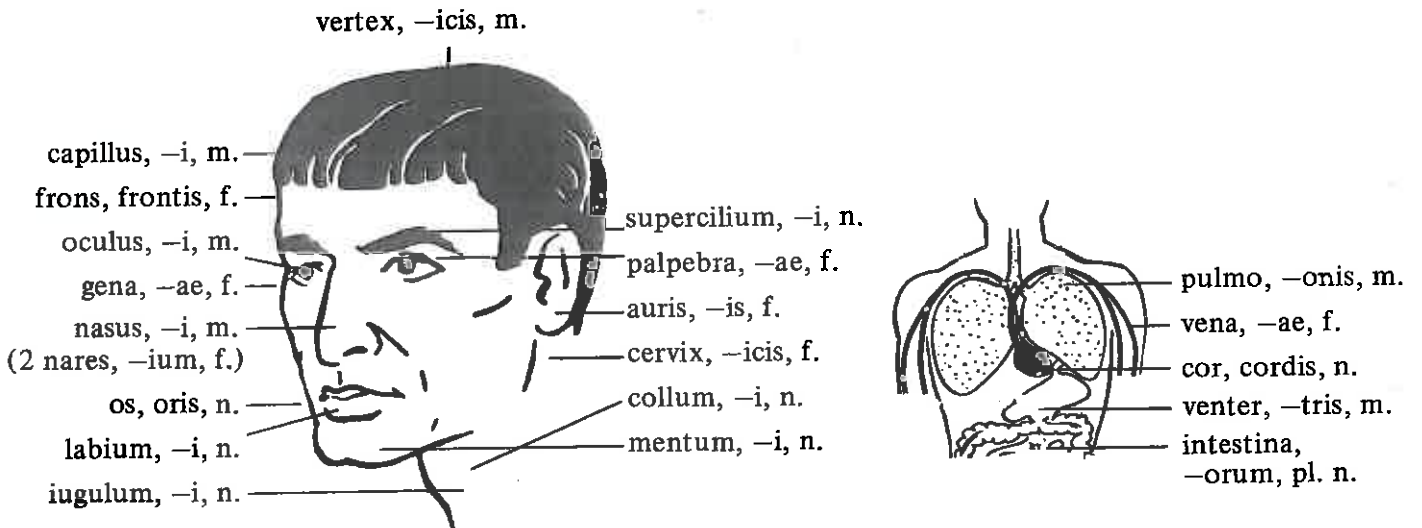
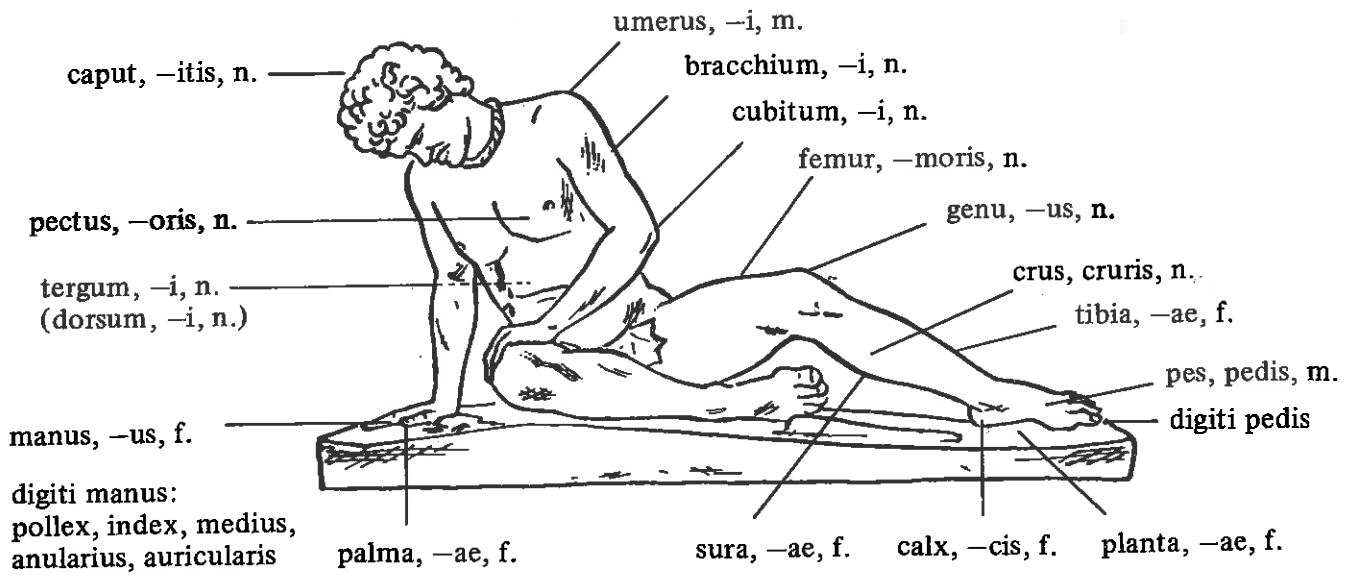

## corrigia -ae, f.

corrigia est lorum, quo calcei et *caligae* ligantur, saepe e corio canino facta.



calcei corrigiis ligati

## cortina -ae, f.

a) cortina est vas rotundum et concavum ad varios usus.

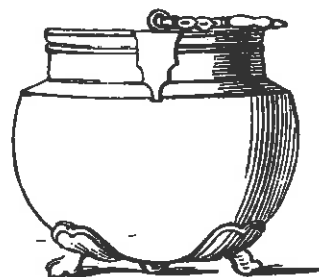

cortina

b) latiore sensu cortina dicitur *tripus* ipse Apollinis, ex quo responsa oraculorum dabantur, quod tripodi impositum erat vas cortinae similitudinem habens.

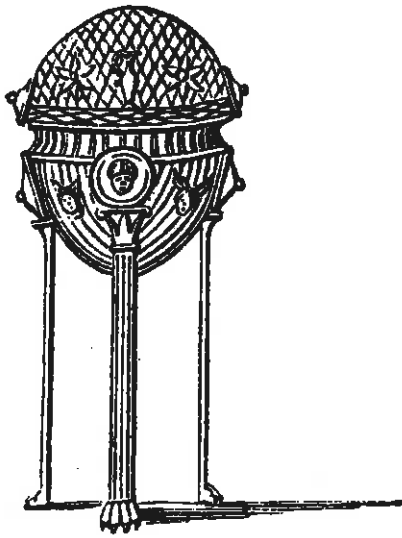

cortina in tripode

### cos cotis, f.

a) cos est lapis, quo ferramenta acuuntur, gemmae, pavimenta et similia poliuntur. (*acus, acies*).

Horatius, A. P. 304/5:

„fungar vice cotis, acutum reddere quae ferrum valet, exsois ipsa secandi.“

Plinius, N. H. 34, 145:

exacuendo oleariae cotes aquariaeque differunt et oleo delicatior fit acies. („cum exacuendo oleariae cotes aquariaeque differant et oleo delicatior fiat acies.“)

b) translate: Florus, epit. 1, 19, 3:

„quasi cote quadam ... ferrum suae virtutis acuebat.“



imago cotis sumpta est e *gemma* Romanā. genius alatus (*ala*) cote sagittam acuit.

### cothurnus -i, m.

a Graeco *kóthornos*, est calceamenti genus virorum aequae ac mulierum, ex corio (corium),

usque ad dimidiam cruris partem, quo et venatores (*venatio*) et tragoediarum (*tragoedia*) actores utebantur. Sed venaticus cothurnus et tragicus formā differunt, quia tragicus subere (suber) altius sublevato fiebat.

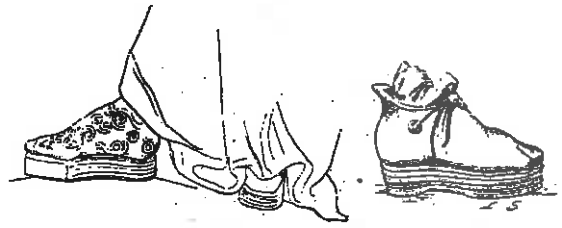

### crates -is, f.

a) crates est instrumentum ex subtilibus lignis vel viminibus aliāve materiā, directis transversisque modico intervallo contextis, ad varios usus.

b) crates ferrea carni torrendae inservit.

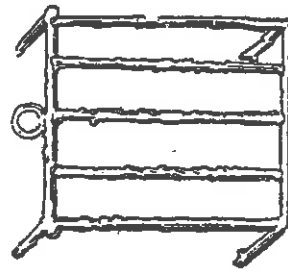

crates ferrea

### crepido -inis, f.

est basis alta et erecta, fundamentum, fulcrum. crepido est moles alta et abrupta, quā maris *litus* vel ripa fluminis munitur contra aquarum impetū.

crepidines viarum sunt margines vel gradus ex petra, ipsā viā aliquanto editiores, qui et commodius praetereuntibus iter et meliorem domibus accessum praebent.



semita Pompeiorum cum crepidinibus

## crepitaculum -i, n.

est instrumentum ludorum ex aere aliāve materiā, quod manu concussum crepitat ac sonum reddit.

Martianus Capella, 9, 314:

„infantibus crepitacula vagitūs abrumpunt.“  
vox derivatur a voce crepitus, crepitare: pedum crepitus, cardinum crepitus. formula dicendi: crepitus digitorum, vel crepere digitis.

Martialis, 3, 82:

„digiti crepentis signa novit eunuchus.“

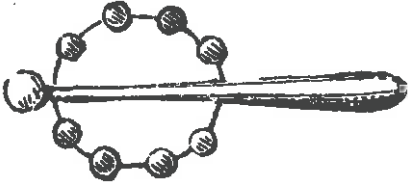

## cribrum -i, n.

est instrumentum crebris et minutis foraminibus pertusum, ex pellibus perforatis, vel lino, aut



cribra in opere caelato sepulcri Eurysacis pistoris (*pistor*), Romae

setis, aliave materia contexta, quo frumenta, farina, et alia cernuntur et purgantur.

**proverbium:** „cribro aquam ferre“ dicitur pro operam perdere, frustra laborare.

verbum derivatum: cribro, -as, -avi, -are = secernere, purgare.

## crista -ae, f.

a) crista est apex in vertice gallinaei generis.

Plinius, H. N. 10, 156:

„gallarū generositas spectatur cristā erectā“

b) dicitur etiam de apice galeae (*galea*).

Livius, 9, 40:

„cristatae galeae, quae speciem magnitudini corporum adderent.“



cristae in galeis

## crypta -ae, f.

a Graeco krypto = „abscondo“.

crypta est locus fere subterraneus fornice (*fornix*) tectus cum fenestris (*fenestra*) in

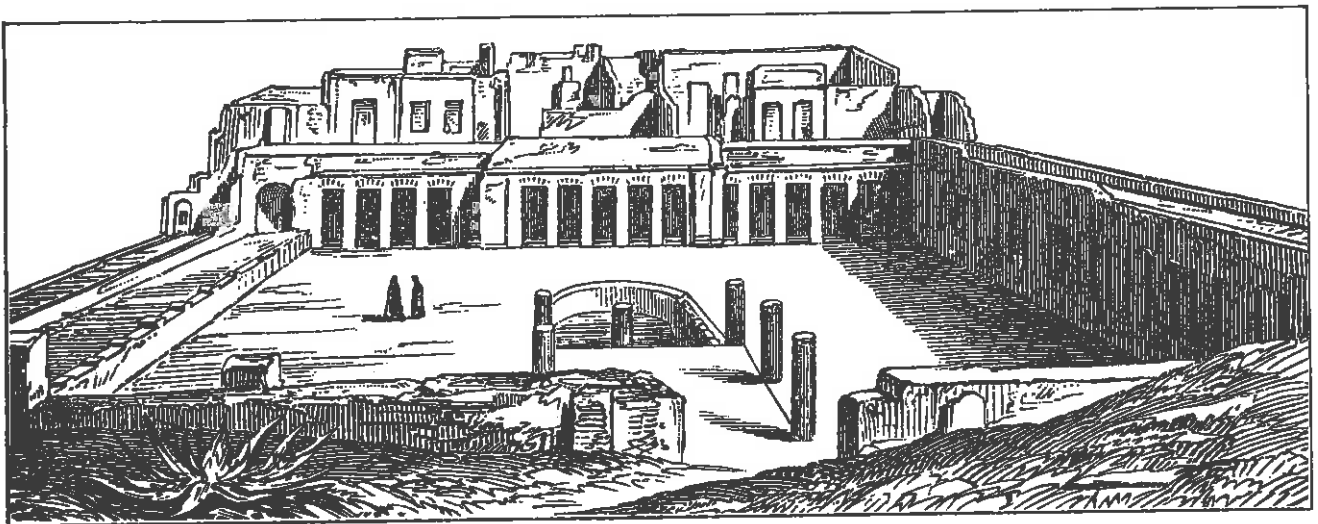

crypta villae Pompeianae

summitate modo. saepe haec vox de granario subterraneo usurpabatur.

Vitruvius 6, 5, 2:

„in aedibus cryptae, horrea, apothecae, ceteraque quae ad fructus servandos magis quam ad elegantiae decorem possunt esse.“

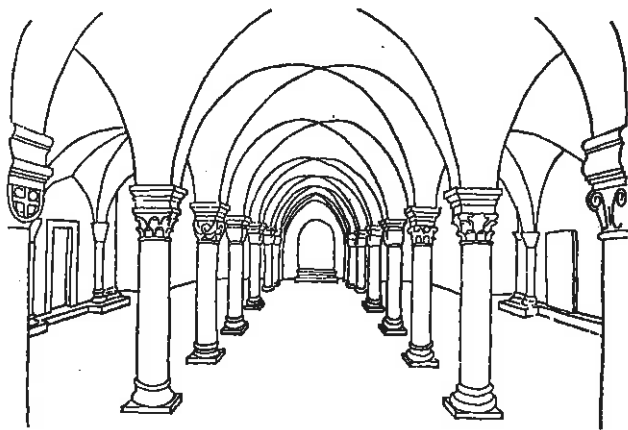
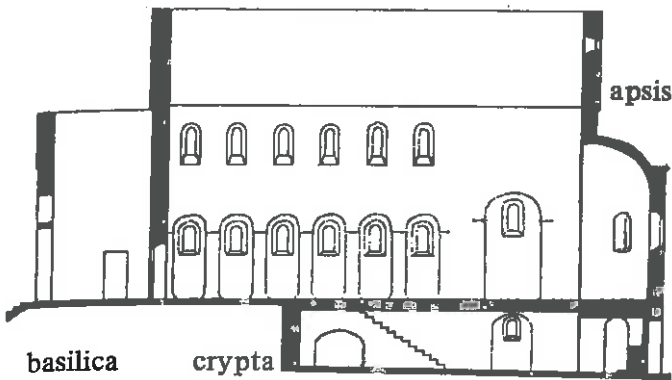

\*\*crypta est pars inferior aedis sacrae, aram, sepulcraque sanctorum complectans.

### Ctesibica machina

est machina, quae in altitudinem aquam educit. fuit autem Ctesibius vir Alexandrinus, qui sub Ptolemaeo Philadelpho floruit et pneumaticam rationem atque hydraulica organa (organum) repperit.

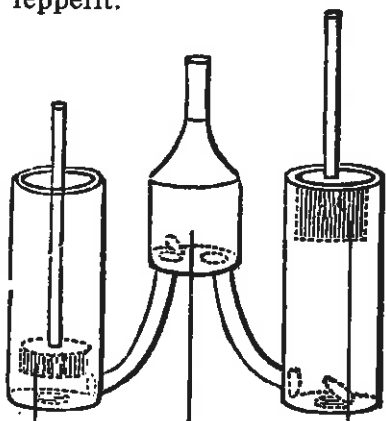

### cuculla -ae, f. / cucullus -i, m.

est pars vestis a tergo pendentis, qua caput tegitur pluviae vel tempestatis causā.

cucullatus est is, qui vestem cum cuculla fert.

\*\*multi monachi vestem cucullatam gerunt.



agricolae cucullati, qui olivas metunt



puerulus cucullatus

cucullus erat etiam involucrum chartaceum, quo a pharmacopolis aliisque institoribus pulveres ac similia clauduntur.

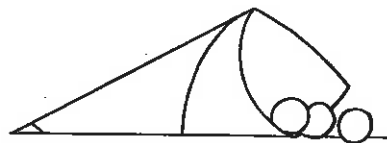

### culex -icis, m.

culex est perexiguum animal, tenuissimis pennis, longisque et exilibus cruribus instructum, circa palustria praecipue degens, sanguinisque avidissimum, praecipue humani, et non solum spiculi acumine, sed bombi sono molestissimo infestum.

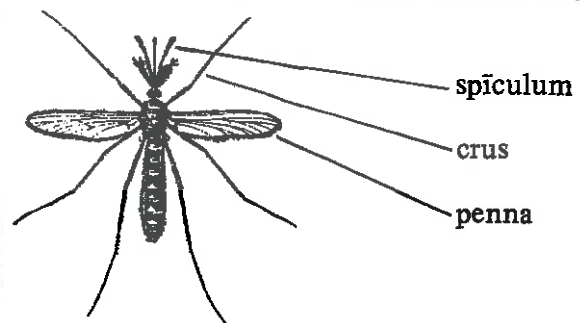

culina —ae, f. / coquina —ae, f.

utensilia culinae domus Pompeianae:



culter —tri, m.

in hac imagine depicta est taberna cultrarii, qui cultros cuiusque generis et formae vendit:

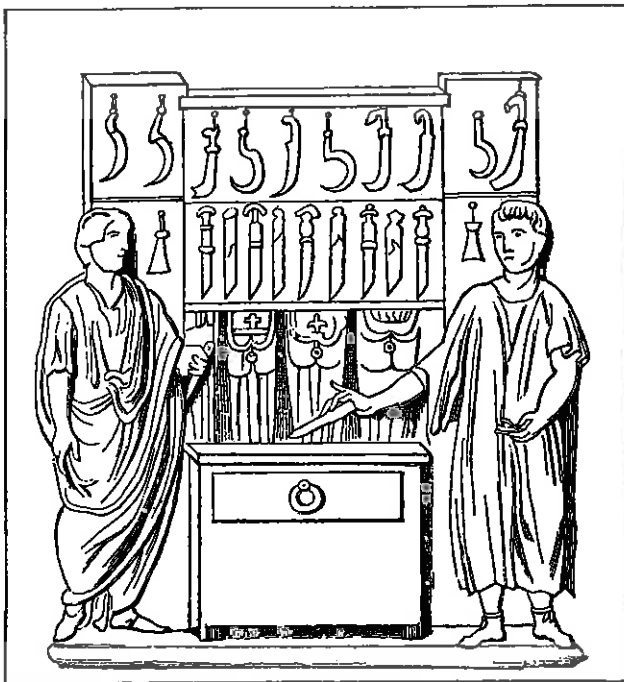

cumulus —i, m.

cumulus est acervus multarum rerum in altitudinem congestarum.

formula dicendi: struere cumulos auri.

\*\*cumulus est configuratio nubium, quae tempestatem aut bonum tempus praenuntiant.



cuneus —i, m.

a) cuneus est instrumentum ferreum aut ligneum, quo finduntur ligna, cuius pars inferior acuta est, superior lata et ampla.

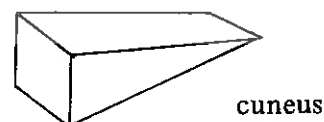

Vergilius, G. 1, 144:

„... cuneis scindebant fissile lignum.“

b) cuneus improprie dicitur quidquid cunei figuram refert.

c) sumitur et pro sedilium ordine et scalarum directione in theatris (*theatrum*) et amphitheatris (*amphitheatrum*), quae ita cum praecinctionibus disposita erant, ut universam sedilium seriem in partes cuneorum similes dividerent.

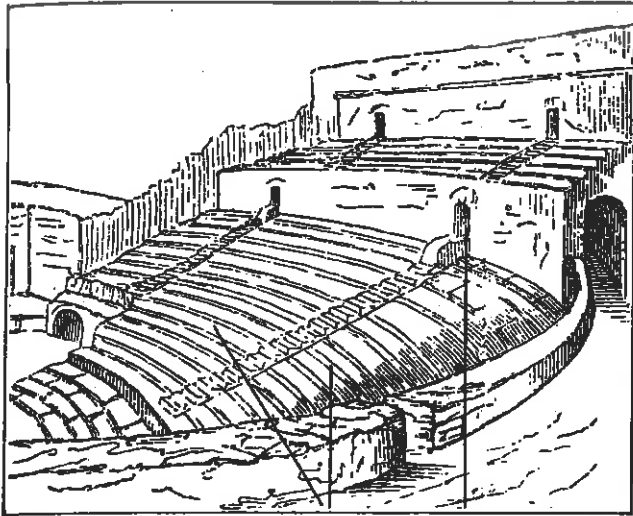

cunei vomitorium

cuniculus -i, m.

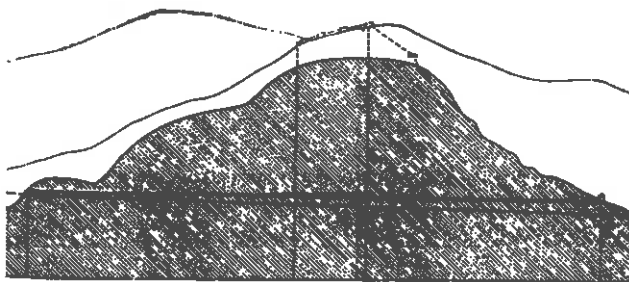
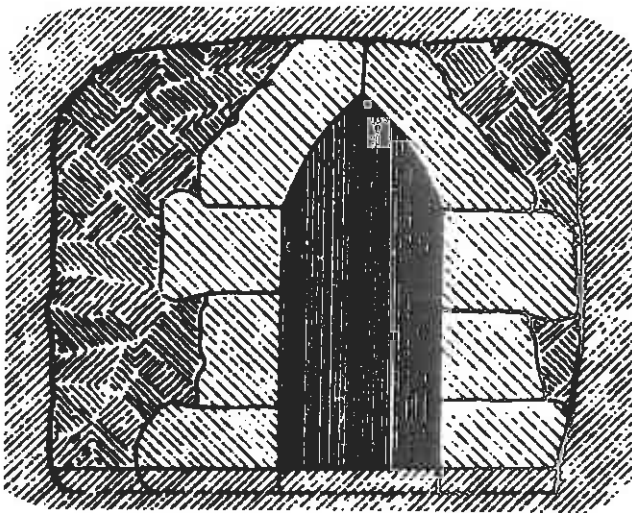

Eupalini architecti cuniculus

a) est animal lepori (*lepus*) simile, sub terrā effossā latēre solitum, ex Hispaniā oriundum.

b) est meātus subterraneus, praesertim qui fit urbium oppugnandarum causa.

Caesar, B. G. 8, 43:

cuniculis venas fontis interciderere atque avertere.

cupa -ae, f.

cupa est ligneum vas vinarium amplum in quo mustum e torculari (*torculum*) excipitur et diffunditur servandi causā.

Cicero, Pis. 27, 67:

„pistor domi nullus, nulla cella; panis et vinum a propolā atque de cupā.“

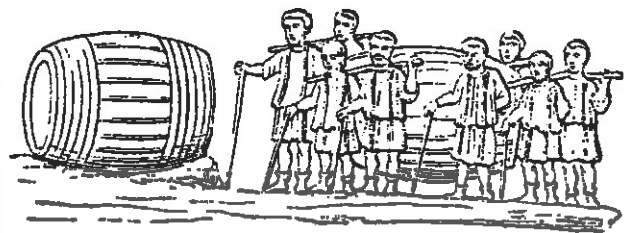
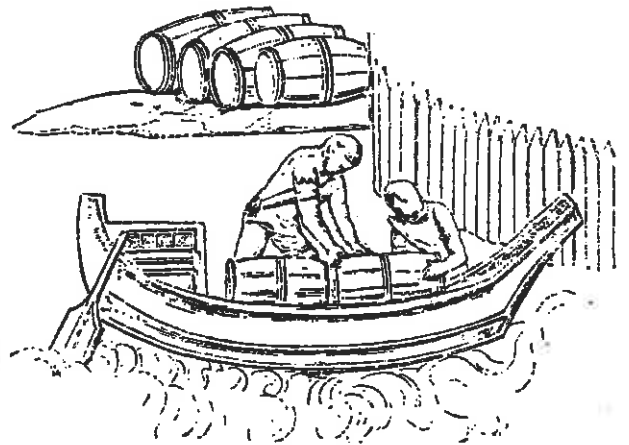

cupa gravis ab octo servis portatur

Cupido -inis, m.

Cupido est Veneris filius, formosissimus omnium deorum, puer arcu (*arcus*) et sagittis (*sagitta*) armatus.

Plautus, Pers. 26/27:

„... saucius factus sum in Veneris proelio, sagittā Cupīdo cor meum transfixit ...“

nomen eius deductum a nomine verbali „cupīdo“ -inis, f., a „cupio, cupivi, cupitum, cupere“

saepe occurrit etiam plurali numero:

Catullus, 3, 1:

„Lugete, o Veneres Cupidinesque“



Venus (Aphrodite), quam quattuor Cupidines (Erotes) comitantur

### currus –us, m.

currus est vehiculi genus, hominibus per urbem aut in itinere vehendis aptum, duabus rotis munitum.

speciatim dicitur de curru, quo triumphantes in Urbem vehebantur. (*triumphus*)

Cicero, Verr. 5, 30, 77:

„at etiam qui triumphant, cum de foro in Capitolium currum flectere incipiunt ...“

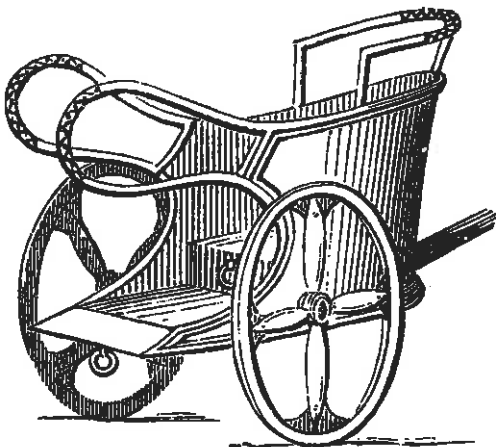

currus

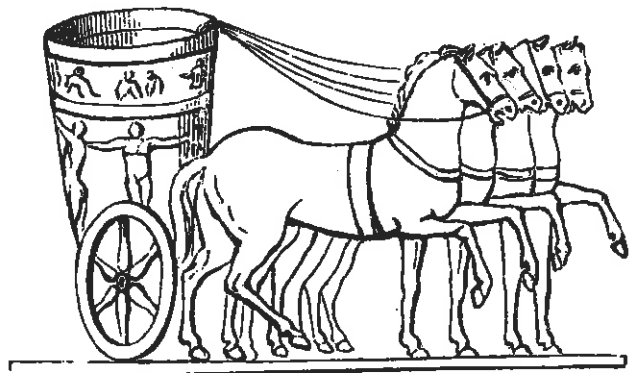

currus triumphalis

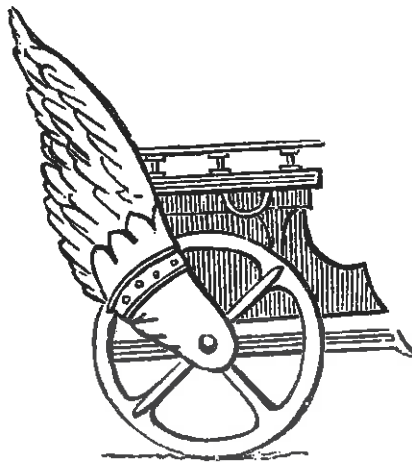

currus volucris vel alatus

### curulis, sella curulis

sella curulis fuit unum ex insignibus (*insigne*) primum quidem regum Romanorum, deinde, iis exactis, maiorum magistratum solummodo, nempe consulum, praetorum, censorum et aedilium eorum, qui de patribus creati sunt, ut distinguerentur ab aliis aedilibus sellae ius non habentibus. sella curulis erat curvis pedibus, signis (*signum*) ornata, sublata gradibus, insculptaque et distincta ebore.

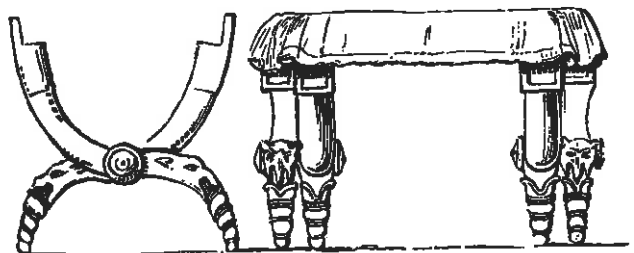



## Daedalus et Icarus

Daedalus primus artifex fuit. Cnossi in Creta insula iussu regis Minois labyrinthum (*labyrinthus*) extruxit. cum a Minoe captivus retineretur, sibi filioque suo Icaro alas cereas perfecit,

quibus ex insula evaderet. Icarus autem, nimis fidens alis cereis soli appropinquavit. alis calore solis liquefactis in mare cecidit et haustus est aqua.

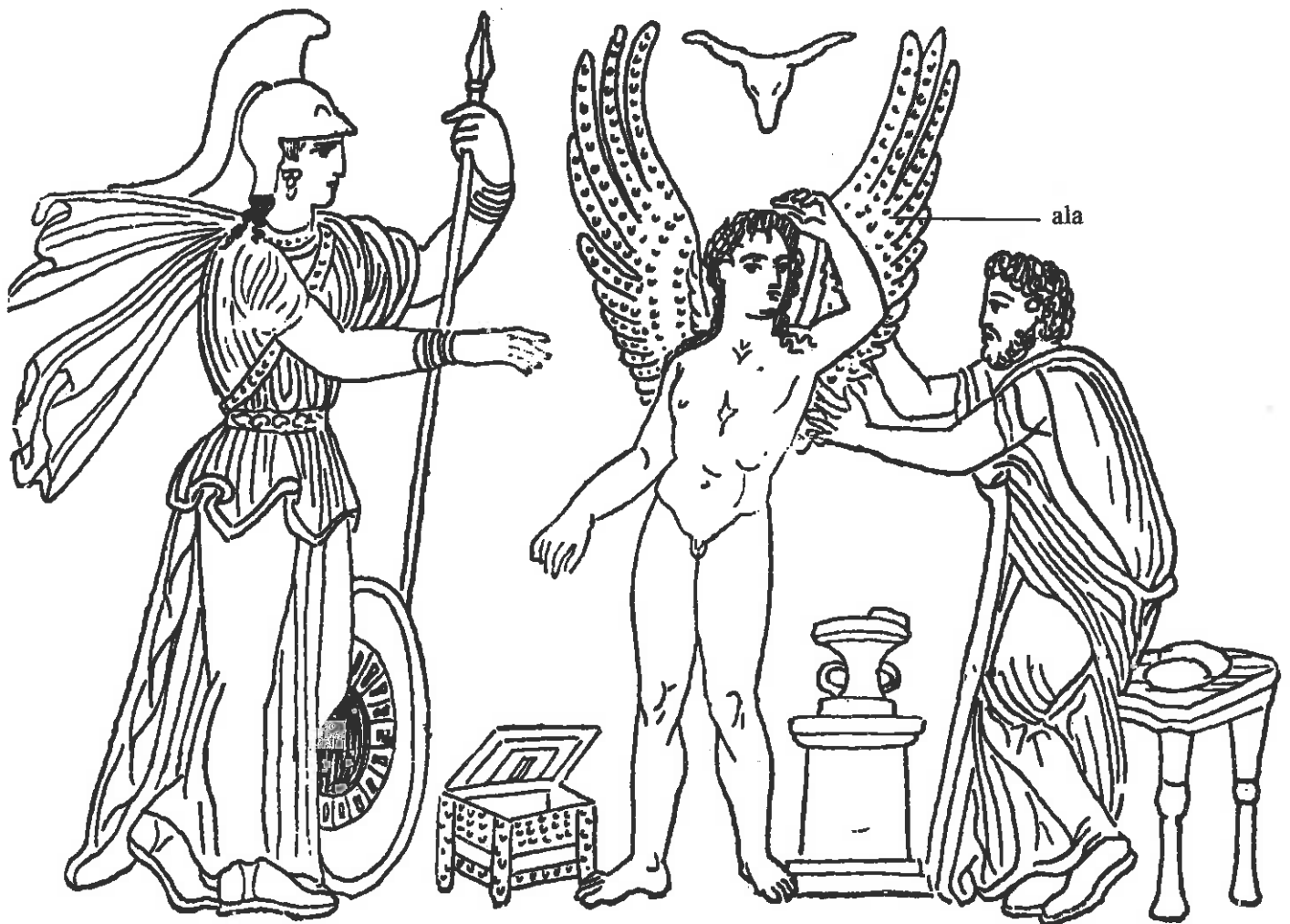

### \*dalmatica —ae, f.

Isidorus, orig. 19, 22, 9:

„dalmatica vestis primum in Dalmatiā provinciā



(Pannonia) Graeciae texta est, tunica sacerdotalis candida cum clavis (*clavus*) ex purpurā.“

### Danaides —um, f. pl.

filiae Danaï, regis Argorum. fabulantur quinquaginta eum habuisse filias eiusque fratrem Aegyptum totidem filios, qui ne ille de filiabus per generos ac nepotes potentior factus ius ablatum sibi vindicaret, ab eo petiit ut filiis suis filias daret uxores, cui Danaus maligne annuit. sed nuptiis vix celebratis sponsae (*sponsus*), a patre instigatae, sponso omnes nuptiali nocte occiderunt, demptā Hypermnestrā, quae Lynceo pepercit; cuius delicti poenam subeunt in inferis, ad dolium pertusum aquā implendum dam-

natae, e quo tantundem effluat quantum infundatur.



### declamatio –nis, f.

est actio declamandi, i. e. domestica exercitatio parandae eloquentiae causā; est exercitatio illa,



puer declamans in ludo

quā pueris in ludis ficta quaedam themata solent praescribi, quibus ad eloquentiam viam sibi sternunt. (*educatio*)

### decumanus –i, m.

a) decumanus ager est ager, qui decimam partem fructuum pro vectigali solvit rei publicae.  
b) decumanus limes est, qui ab oriente ad occidentem ductus est. prius decumanus dictus est duodecimanus, ab hora duodecima diei, qua sol occidit: spectat enim in occidentem. (*cardo*)

### decursio –onis, f.

decursio speciatim dicitur pro exercitatione militari. decurrere milites dicuntur, qui magnā multitudine ac pompā ad solemne aliquod sacrum ex ordine procedunt.



### defectio /eclipsis

defectio vel eclipsis lunae fit, cum sol per interpositionem terrae ita lunae opponitur, ut illum illustrare non possit; eclipsis solis, cum luna inter solem et nostrum aspectum interponitur.

Cicero, de div. 2, 6, 17:

„solis defectiones itemque lunae, praedicuntur in multos annos.“

luna

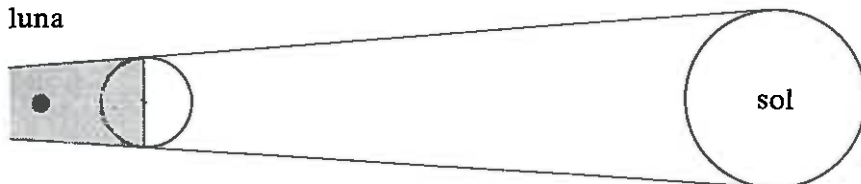

defectio lunae

terra

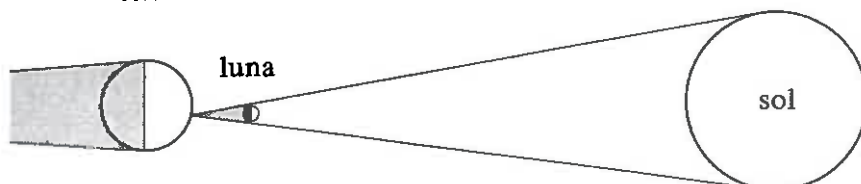

defectio solis

sacrum Apollinis

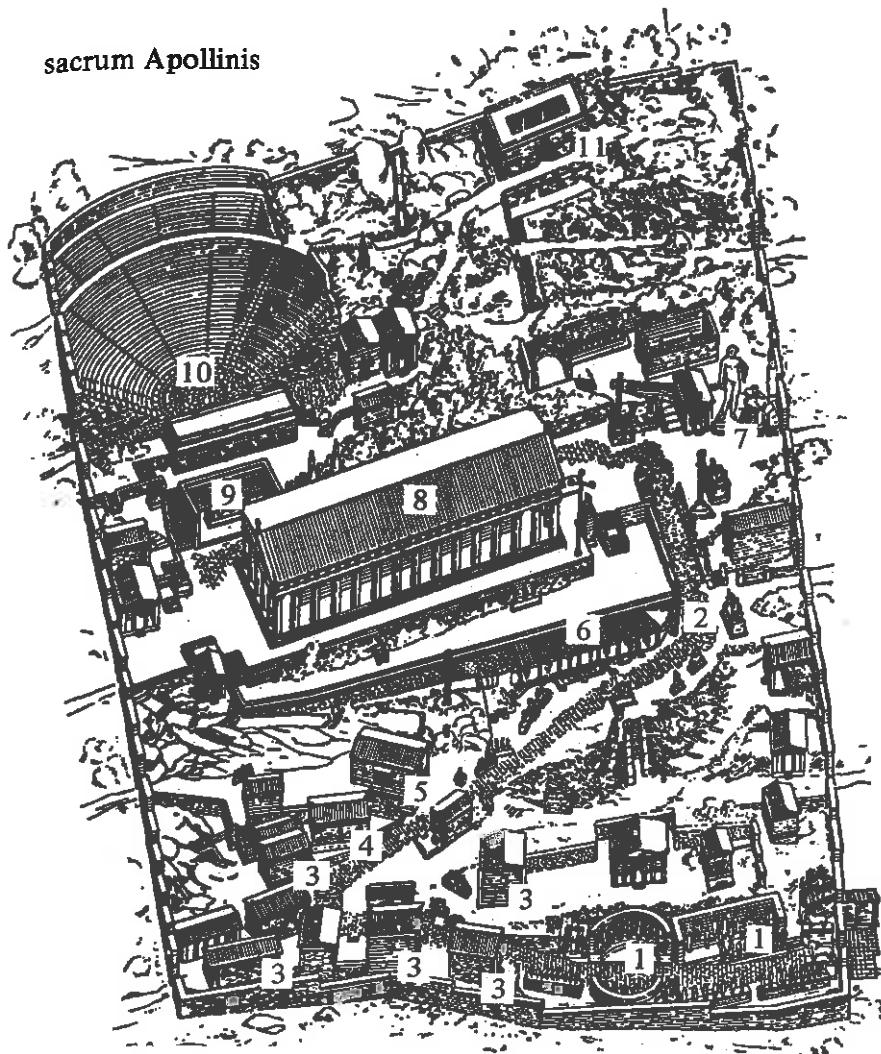

- 1 dona votiva
- 2 via sacra
- 3 thesauri
- 4 Atheniensium thesaurus
- 5 curia
- 6 aula Atheniensium
- 7 statua Apollinis
- 8 templum Apollinis
- 9 Alexandri venatio leonum
- 10 theatrum
- 11 aula Cnidiorum

diadema —atis, n.

est regium *insigne* capitis, candida fascia, vitta, qua regia frons praecingebatur. saepe diadema ex auro et gemmis contextum est. „diadematus“ est is, qui diademate ornatus est.



Constantinus Constantiusque imperatores, diademate ornati

diatretum (sc. vas diatretum)

in quo tessellato opere aurum, argentumve aut gemmae insertae sunt. vas diatretum e vitro factum, ornamentis vitreis induitur quemadmodum vas diatretum in imagine expositum.

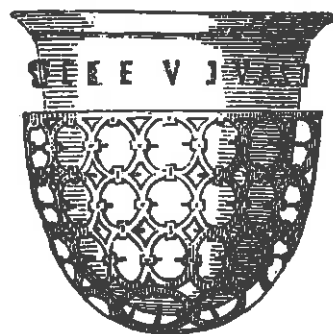

**dies** –iei, m./f.

apud Romanos dies et nox in duodecim horas dividebatur, quae secundum tempus anni longiores aut breviores erant.

in castris nox quattuor vigiliis (*vigiles, vigiliae*) constabat. interdiu hora prima ab ortu solis numerabatur (plus minus horae sextae nostri temporis congruit), hora tertia media erat inter ortum solis et meridiem. hora sexta meridie coepit, hora nona media erat inter meridiem et occasum solis. aestate ab hora sexta cum maximus erat calor, Romani somnum capere solebant (a quo italiane: la siesta).

prima, tertia, sexta, nona in coenobiis tempora orationum et cantuum sunt, quae nomina ab his horis capiunt.

tabula monstrat quomodo Romani in aequinoctiis (aequinotium, solstitium) diem et noctem mensi sint.

a die adiectivum diurnus derivatur (*acta diurna*), a nocte autem nocturnus.

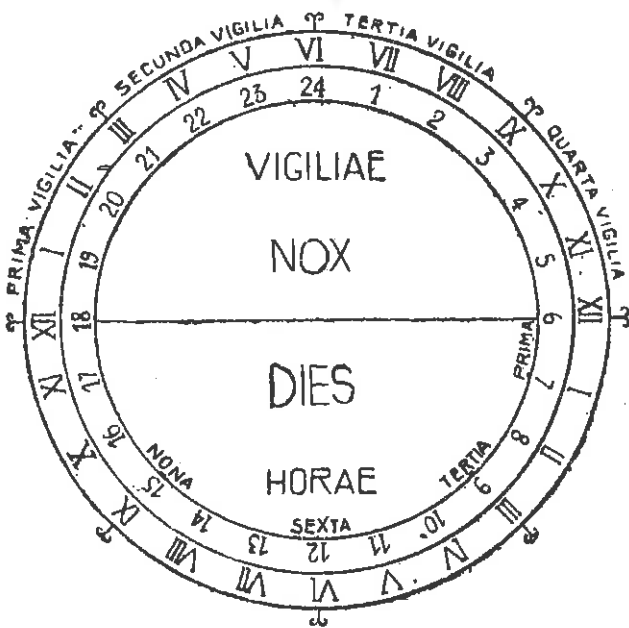

**digitale** –is, n. / digitabulum –i, n.

digitale est tegumentum digiti, quod mulieres in suendo induunt ne acu (*acus*) laedantur.

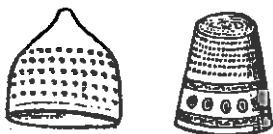

digitalia etiam dicuntur tegumenta omnium digitorum e panno facta, quae vitandi frigoris vel iniuriae laborum causā induuntur.

**diluvium** –ii, n. (vel diluvies –ei, f.)

diluvium est inundatio aquarum ab immodicis imbribus, marisque aut fluviorum incrementis terras operiens.

Ovidius, Met. 1, 291/2:

„iamque mare et tellus nullum discrimen habebant:

omnia pontus erant, deerant quoque litora ponto.“

adi. diluvianus, antediluvianus, postdiluvianus.

HERBARIUM  
*DILUVIANUM*  
collectum

JOHANNES JACOBO SCHEUCHZER, MED. D.  
Mathes. Prof. Tigurino, Acad. Leopold. Carol.  
et Soc. Regg. Anglicae ac Prussicae Membr.

*Edidit. Novissima duplex Auctior.*

*laticum concussa lacunas  
Laudit hians Tellus, et Fontibus ora relaxat:  
Succutiturque pavens, et fundamenta revelat,  
Et reserat Chaos. Aeterni sic vox tonat oris:  
Sic formidanda grave spiritus infremit ira.  
Buchan. in Psalm. xxviii.*

LUGDUNI BATAVORUM,  
Sumptibus PETRI VANDER Aa. Bibliopole.  
*Civitas atque Academia Typographi.*  
M D CC XXIII.

imago in *frontispicio* operis Scheuchzerii: diluvium biblicum repraesentatur cum *arca* Noe. versus sunt Buchanani, celebris poetae Scotici, saeculi XVI. p. Ch. n.

diptychum —i, n.

est id, quod duas valvas habet. tabellae plicatiles, quae panduntur et clauduntur habentque usum litteris praesertim amatoriis, conscribendis. diptycha consulum, quaestorum, etc. erant ta-

bellae eorum nominibus inscriptae, et imaginibus adornatae, quas ipsi ad amicos mittebant apophoreti vice, et in vulgus spargebant ipso die magistratus initi.



diptychum consulis Rufii Probiani, ex ebore factum (= diptychum eburneum)

## divortium —i, n.

idem est quod deverticulum.

a) dicitur de loco, in quo a via militari devertimus: divortium itineris.

b) item ubi aquae in diversas partes defluunt, ut sunt cacumina montium.

Cicero, ad Att. 5, 20:

„mons Amanus, qui Syriam a Cilicia ima aquarum divortio dividit.“

c) speciatim dicitur de discessione coniugum et dissolutione matrimonii.

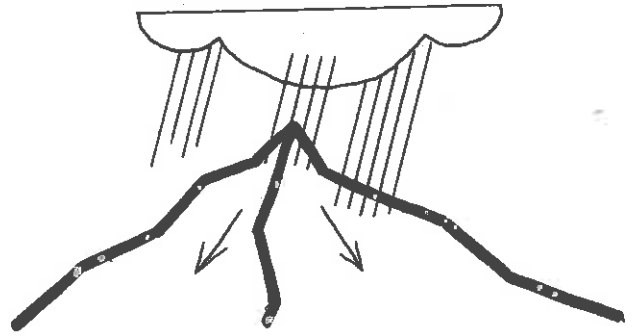

## dolium —i, n.

est vas ex maioribus, quibus vinum conditur, et in cellis servatur, capax, rotundum et ventricosum.

primo dolia fuerunt fictilia, deinde etiam lignea et multo capaciora, asservis vimine constrictis, ut hodieque apud nos. (*cella vinaria, cupa*)

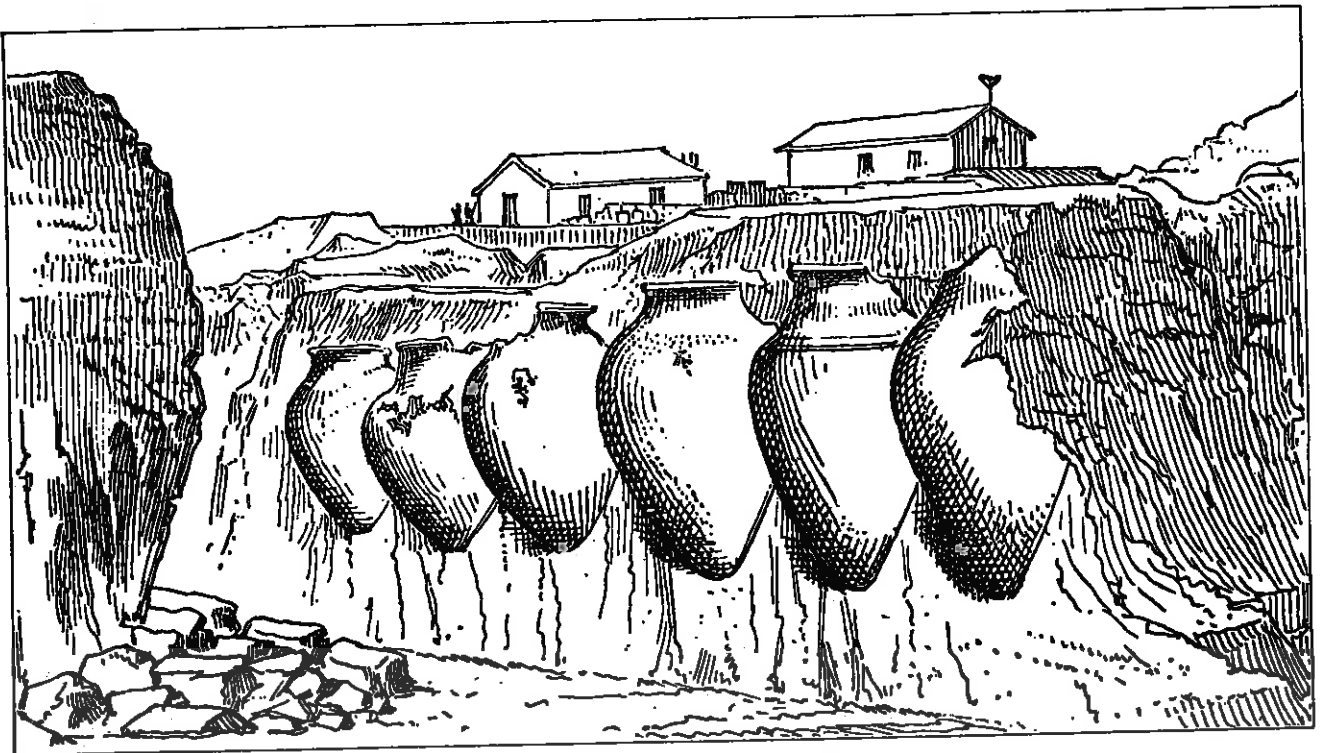

dolia fictilia prope Troiam inventa

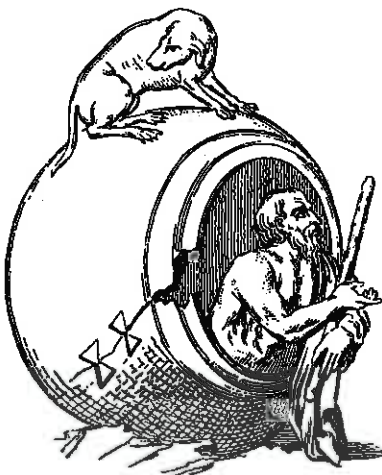

Diogenes philosophus cynicus Athenis in dolio parce vixit. cum Alexander Magnus eum interrogaret, si quid vellet, respondit: „paululum a sole!“

# domus Romana cum atrio et peristylis

peristylum (aut peristylum) est aula magna multis columnis circumdata, interior pars subdivo est.

tablinum: in tablino tabulae rationum reponbantur.

peristylum

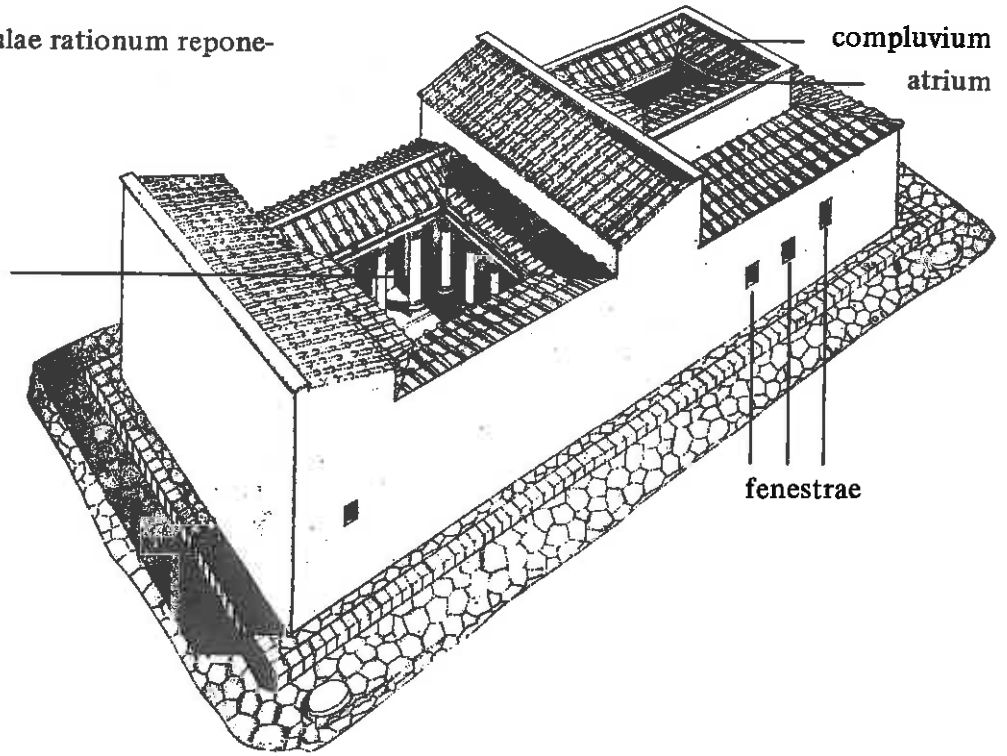

orthographia

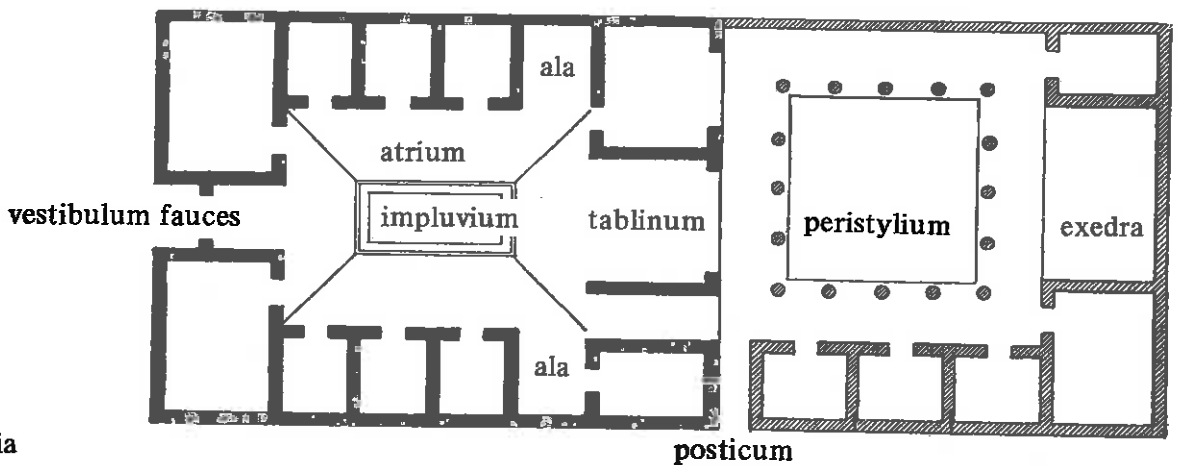
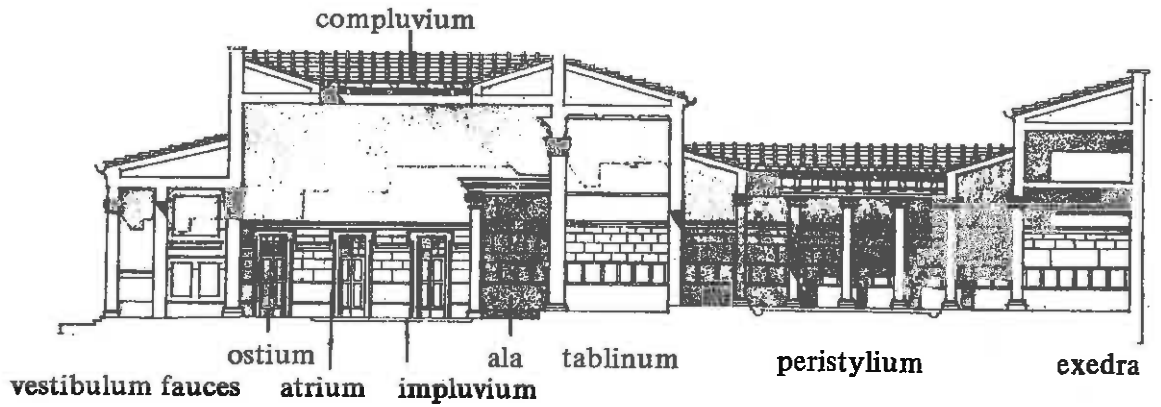

ichnographia

# domus Romana cum tabernis

pluvia per compluvium in impluvium cadit.  
 impluvium in medio atrio situm est. cubicula  
 aliaque conclavia circum atrium sunt.  
 duo conclavia in viam aperiuntur; locata sunt  
 tabernariis, qui hīc officinam suam habent.

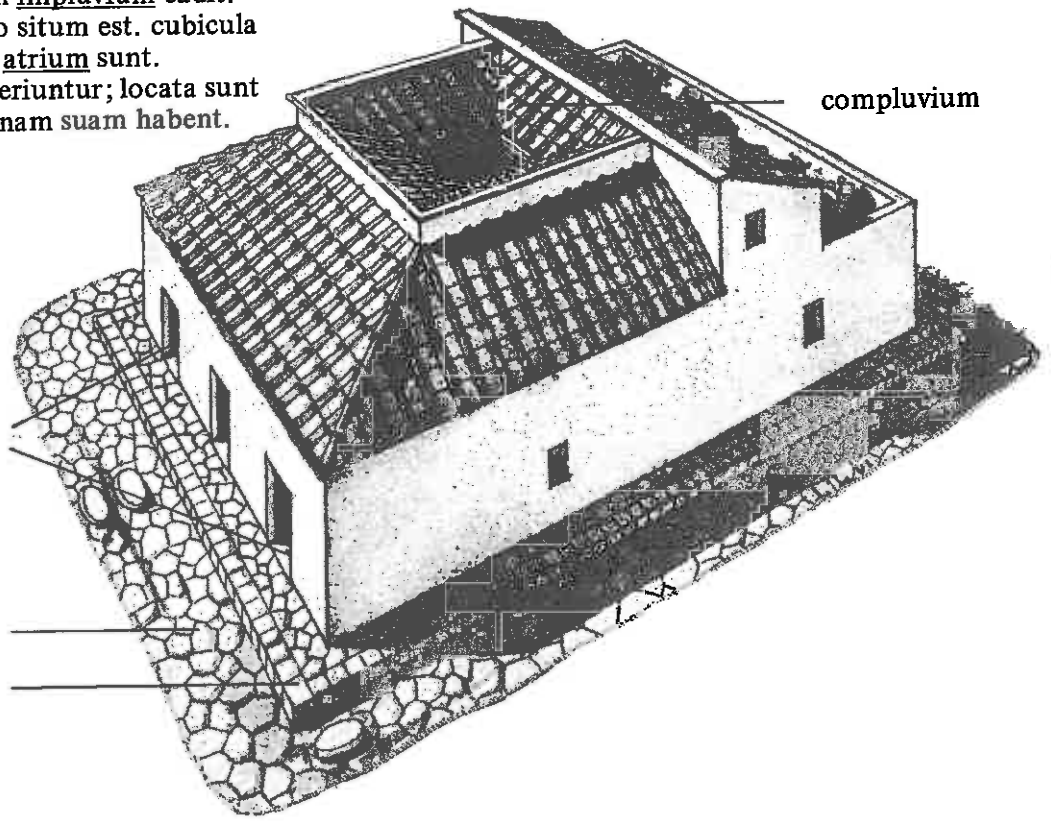

tabernae

via

crepido

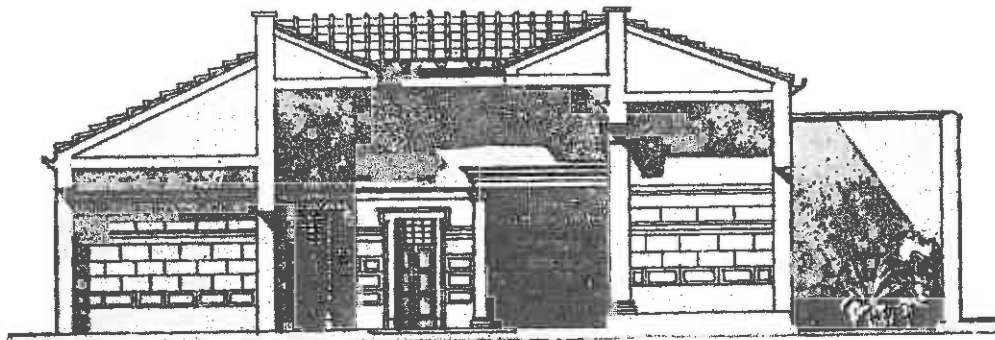

orthographia

fauces

atrium

ala

tablinum

hortus

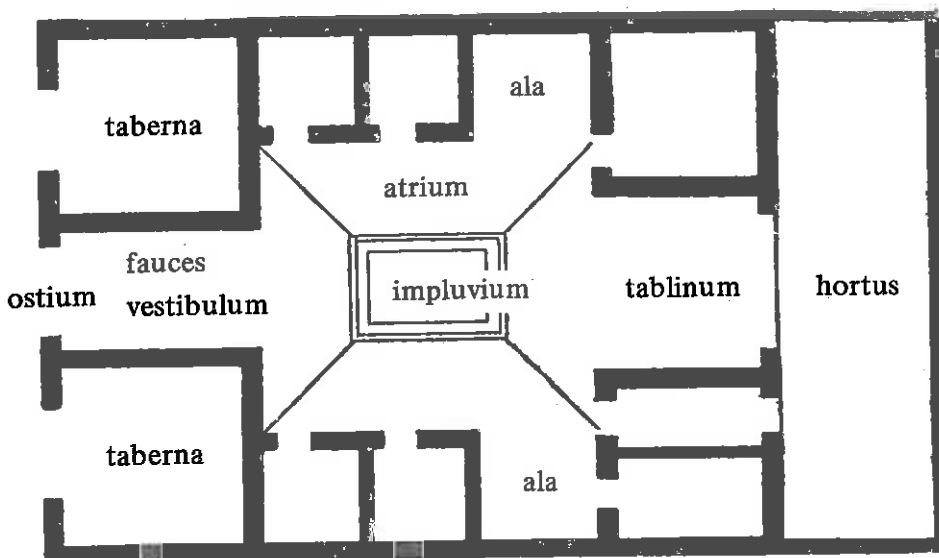

ichnographia



**donarium** –ii, n.

strictiore sensu est quodvis donum deis consecratum.

Capitol. Maximin. 19, 4:

„fana diripuit, donaria militibus divisit.“  
quia donaria deis vel deo saepe ex voto offerata sunt, etiam „ex voto“ nominantur hodie.

donarium in Pannonia  
reperitum his verbis  
conceptum est:

EGO ZENO  
VIVS VOT  
UM POSUI

VIVS pro VIVVS

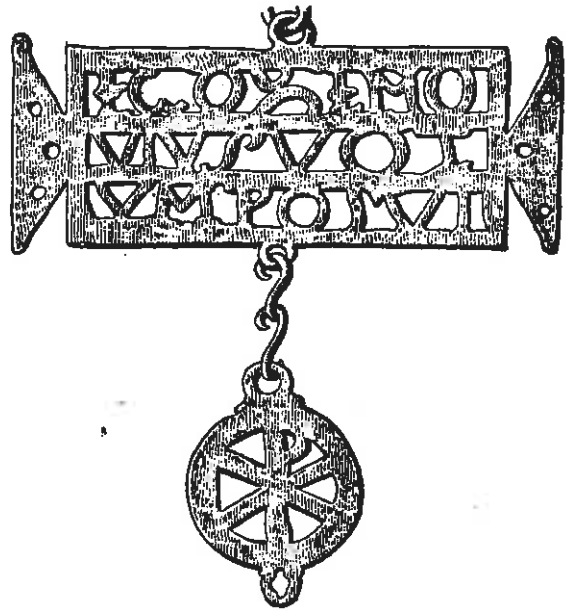

## educatio –onis, f.

educatio est institutio ac disciplina puerorum a primā infantiā usque ad iuventutem.  
imago vitam pueri Romani monstrat: mater

infantem lactat praesente patre; pater puerulum bracchio tenet; puer ludens curru ariete iuncto vehitur; puer in schola ante magistrum declamat.

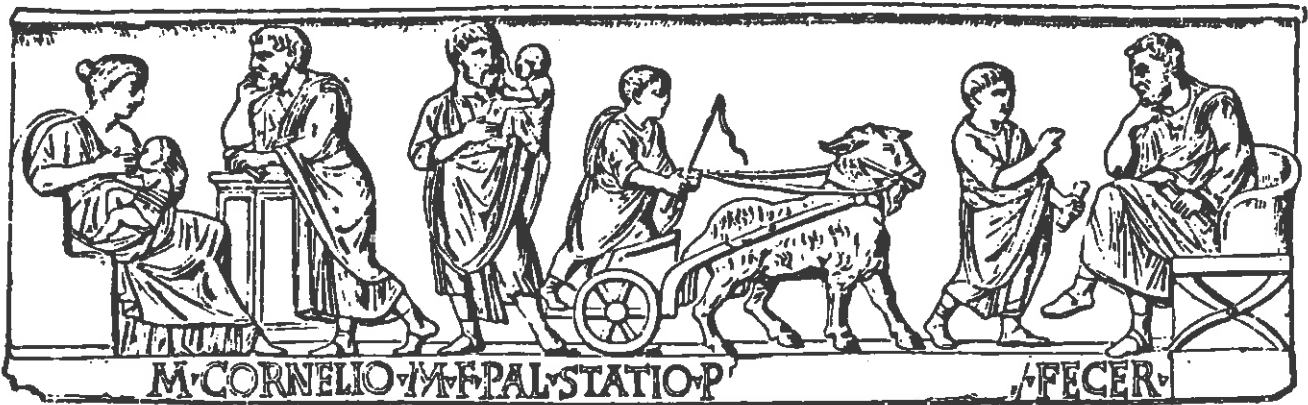

## elementa –orum, n. pl.

a) sunt principia omnium rerum, e quibus reliqua omnia componuntur et in quae resolvuntur. temporibus antiquis quattuor elementa nominabantur.

Seneca, Ira 2, 19:

„cum elementa sint quattuor, ignis, aqua, aer et terra, potestates pares his sunt, frigida, fervida, arida atque humida.“

b) elementa dicuntur notae litterarum, quia sunt prima principia orationis; nam ex litteris syllabae, ex syllabis dictiones (vocabula), ex dictionibus oratio conficitur.

c) item principia artium et scientiarum ut arithmeticae, geometriae, musicae etc. elementa vocantur.

\*\*\*elementa hodie numero 104 sunt, e quorum numero aliquot nomina Latina et symbola chemica haec sunt: aurum (Au), ferrum (Fe), argentum (Ag), cuprum (Cu), sulphur (S), oxygenum (O), hydrogenum (H), aluminium (Al), calcium (Ca), carbo (C), chlorum (Cl), magnesium (Mg), argentum vivum = hydrargyrum (Hg), phosphorus (P), radium (Ra), uranium (U) etc.

adi. elementarius: ad elementa pertinens.

## ellipsis –is, f.

ellipsis figura plana est, rotunda, duobus centris praedita, quae a mathematicis \*\*\*foci vocantur. His verbis Athanasius Kircher in Arte magnā lucis et umbrae eius descriptionem dat:

„Ellipsin fili (filum) ope describere: Sit data diameter maior CF, minor HE. in maiori quaeruntur duo centra: quod fiet, si semidiameter maiorem transferas ex alterutro puncto EH, in diametrum maiorem FC, ut supra diximus: prodibunt AB, centra quaesita, quibus infigantur duae acus subtiles, iisque duo fila alligentur; ponatur et in E graphium, cui duo fila ita alligentur, ut laxari amplius non possint; si igitur graphium intra haec fila coniuncta circumducatur, describetur hoc motu ellipsis quaesita. Sed haec omnia vel ex ipsā figurā patent.“

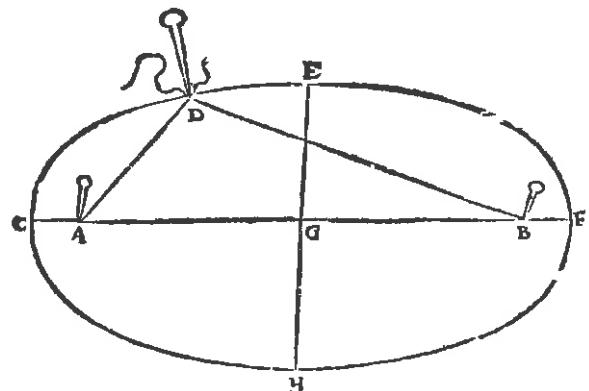

## emblema –atis, n. (vel emblematum –i, n.)

a) emblema est sculptura vel ornamentum vasorum opere caelato (caelator) factum vel varietas pavimentorum (pavimentum) (a verbo Graeco „emballo“ = impingo, affigo).

b) metaphorice ponitur pro ornamento orationis.

Quintilianus, 2, 4, 27:

„(ut) extemporales eorum dictiones his velut emblematis exornarentur.“

c) **\*\***temporibus litterarum resurgentium emblemata sunt imagunculae *symbolum* exprimentes et paucis distichis explicatae, ut monstrat exemplum ex opere Andreae Alciati „Emblematum libellus“ sumptum.

122 AND. ALC. EMBLEM. LIB.

In astrologos.

LIII.



*Iare per superos qui raptus ex aëra, donec  
In mare præcipiem cera liquata daret.  
Nunc te cera eadem feruensq; resusat ignis,  
Exemplo ut doceas dogmata certa tuo.  
Astrologus caueat quicquam prædicare, præceptis  
Nam cadet impostor dum super astra uehit.*

ephippium -i, n.

est stragulum equi, sedendi causa.  
a quarto p. Ch. n. saeculo, ephippio etiam sella  
equestris imponebatur.

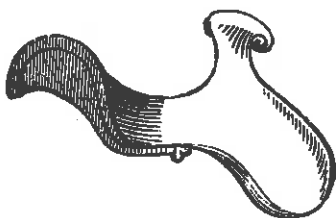

sella  
equestris

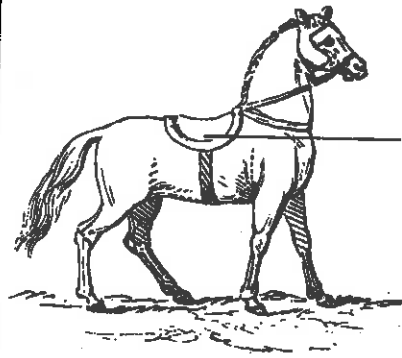

ephippium

epitonium -i, n.

significat instrumentum, quo, prout hoc aut illo modo versatur, liquor emittitur aut oclusus retinetur. in balneis (*balneum*) erat verticillum seu verticillum pertusum, cuius conversionibus aqua e fistulis emittebatur, aut inibi occludebatur.

fistula

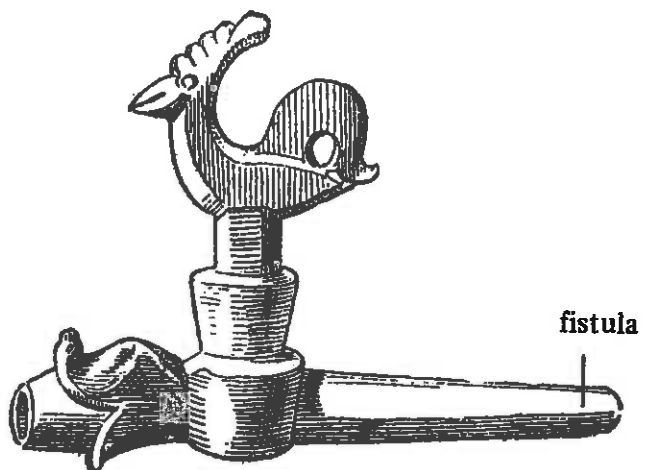
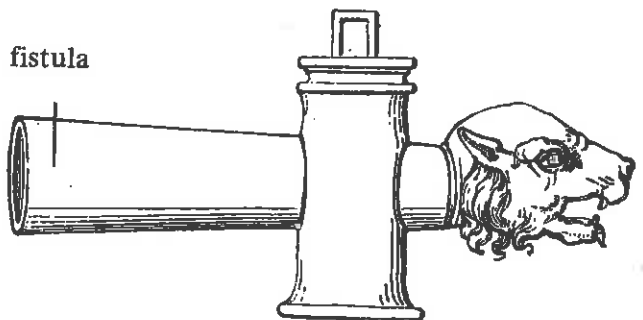

fistula

epitonium Romanum Vindonissae repertum

hodie etiam **\*\*\*epitonium electricum** usurpatur, quo fluidum electricum emittitur aut occluditur:



filum electricum

## erinaceus —i, m.

animal est spinis horridum, qui, ubi venatores senserit, contractis ore et pedibus convolvitur in formam pilae, ne quid praeter aculeos comprehendi possit.

Pilinius, H. N. 8, 133:

„praeparant hiemi et erinacei cibos, ac volutati super iacentia poma, affixa spinis, unum amplius tenentes ore, portant in cavas arbores.“

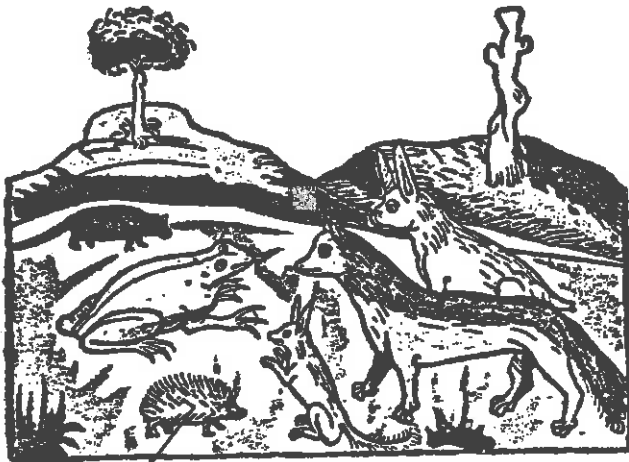

erinaceus inter alia animalia (murem, ranam, leporem, vulpem et lupum) repraesentatur in hāc xylographiā sumptā ex editione imaginibus illustratā Aesopi fabularum anno 1473 Ulmae a Gunthero Zainer in lucem proditā Erasmus, Adag. 4081:  
„(erinacii) cutis detracta cum spinis utilis est ad defricanda vasa.“

## essedarius —ii, m.

est qui *essedum* regit et miles, qui ex essedo pugnat.

Caesar, B. G. 5, 19:

„essedarios ex silvis emittebat, et magno cum periculo nostrorum equitum cum iis confligebat.“

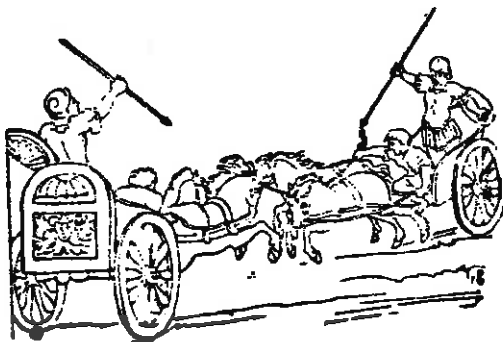

essedarii proeliantes

## essedum —i, n.

essedum est vehiculum birötum Gallorum et Britannorum, vehendis quidem hominibus oneribusque aptum, sed a Gallis praecipue Britannisque usurpatum in bello, cum ex eo pugnare soliti essent. (*essedarius*)

Suetonius, Galba 6, 3:

„ad essedum imperatoris per viginti passuum milia cucurrit.“



## etesiae —arum, f. pl.

sunt venti quidam statis temporibus quotannis flantes, plerumque ab occidente.

Tacitus, Hist. 2, 98:

„mare quoque etesiarum flatu in orientem navigantibus secundum, inde adversum erat.“

## Europa —ae, f.

fuit filia Agenoris, regis Libyae aut Phoeniciae, quam fabulantur a Iove in taurum converso raptam et abductam esse in Cretam et Europam, cui parti mundi nomen dedit.

Paulus Festus, p. 78 M:

„Europam tertiam orbis partem ab Europa, Agenoris filia, certum est appellari. sed alii de amore Iovis in taurum versi narrant; alii eam a praedonibus raptam et navem, quae Iovis tutelam effigiem tauri habuerit, in eam regionem esse delatam; quidam vero ob pulchritudinem regionis per simulationem raptae filiae occupatam eam terram ab Agenore et Phoenicibus ferunt.“



### examen —inis, n.

- a) examen dicitur de apibus, cum ex alveario (*alvearium*) evolant, expulsae a maioribus (*apis*).  
 b) examen est lingula librae seu *libra* ipsa aut actio librandi vel aequilibrium.

Vergilius, *Aen.* 12, 725:

„Iuppiter ipse duas aequato examine lances  
 sustinet ...“

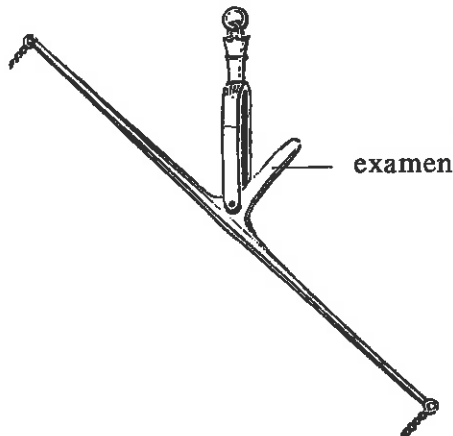

### exedra —ae, f. / exhedra —ae, f.

est locus apertus in porticu (*porticus*) vel etiam sub divo, in quo multae circum positae sellae colloquendi causa.

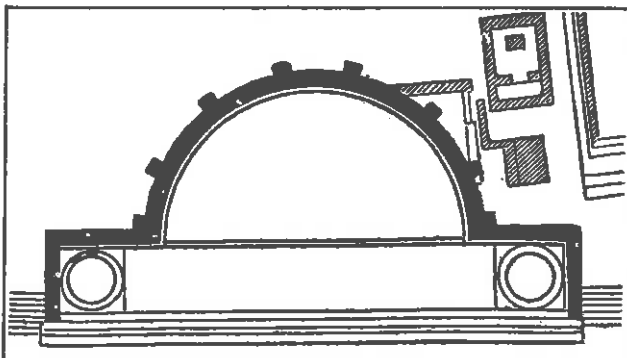

Vitruvius in descriptione aedificii cuiusdam (5, 11, 2):

„constituuntur in tribus porticibus exedrae spatiosae, habentes sedes, in quibus philosophi, rhetores reliquique, qui studiis delectantur, sedentes disputare possint.“

### expositio —onis, f.

expositio est actio exponendi, exempli gratiā corpus mortui in lecto exponitur, ut affines amicique ei valedicant. expositio in rē oratoriā est explicatio vel enarratio cuiusdam rei.

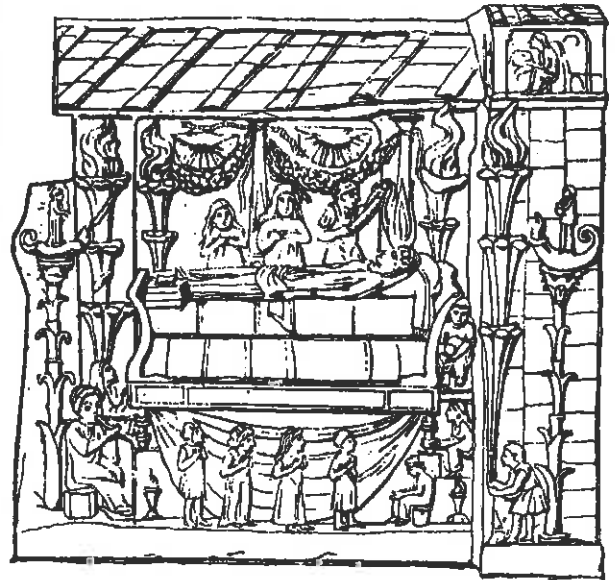

mortuus expositus in lecto

\*\*\*facsimile —is, n.

facsimile est substantivum derivatum a sententia: „fac simile!“ = imitare! facsimilia sunt opera iterum excussa iisdem typis (*typus*) iisdemque imaginibus quam prototypus. saepe *incunabula* hoc modo denuo imprimuntur.

## De Insulis inuentis

Epistola Cristoferi Colom (cui etas nostra multū debet: de Insulis in mari Indico nup inuētis. Ad quas perquirendas octavo antea mense: auspicijs et ere Inuictissimi Ferdandi Hispaniarum Regis missus fuerat) ad Magistricum dñm Raphaelē Sanxis: eiusdē serenissimi Regis Thesaurariū missa. quam nobilis ac litterarū vir Aliander d' Losco: ab Hispano ydeomate in latinū conuertit: tercio kl's Maij. M.D.CCC.XCIIJ. Pontificatus Alexandri Sexti Anno Primo.

Quoniam susceptę prouintie rem perfectam me psecutum fuisse: gratū tibi fore scio: has pstitui crārare: que te vniuscuiusq; rei in hoc nostro itinere geste inuenteq; admoneāt. Tricesimoterio die postq; Gadibus discessi: in mare Indicū perueni: vbi plurimas Insulas innumeris habitatas hominib⁹ reperi: quarū oīm p felicissimo Rege nostro: pꝛeconto celebrato ⁊ vixillis extensis: cōtradicente nemine possessionē accepi. primeq; earum: diuī Saluatoris nomen imposui (cuius frat⁹ auxilio) tam ad hāc q; ad ceteras alias puenim⁹. Eam vero Indi

facsimile epistolae Cristofori Columbi, quae primum imaginibus illustrata Basileae anno 1493 in aedibus Olpe excussa est. prima notitia novarum a Columbo inventarum insularum novi mundi Latine divulgata est!

## fasti —orum, m. pl.

dies fasti dicitur de iis diebus, quibus lege agi licet et forensem iurisdictionem exercere.

Ovidius, Fasti 1, 47 s:

„ille nefastus erit, per quem tria verba silentur, fastus erit, per quem lege licebit agi.“

Haec tria verba Do, Dico, Addico in iurisdictione exercendā solemniter erant.

Hi omnes dies, qui primum pontificibus (pontifex) tantum noti erant, in vulgus editi sunt a

Cn. Flauio qui fastos circa forum in albo (*album*) proposuit.

Fasti dicuntur libri, in quibus perscribentur, quid quoque anno ac die accideret in re publicā, res gestae, honores, templorum dedicationes, magistratum nomina, ratio et ordo dierum festorum fastorumque et multa alia, sicut in annalibus vel in calendario (*calendarium*).

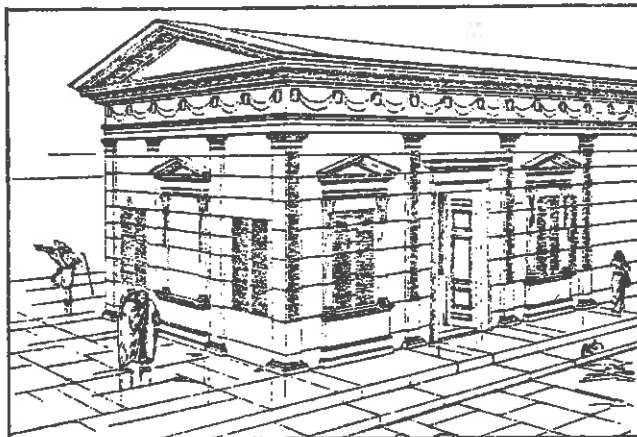

fasti in parietibus Regiae publicati

## fastigium —i, n.

fastigium est summitas tecti, cacumen a latitudine surgens et paulatim in acumen desinens. primum templa fastigia habebant, postea a sacris aedibus transiit ad Caesarum domos, postquam diuinos honores Romani illis tribuere coeperunt.

Caesar, B. G. 7, 69:

„colles ... pari altitudinis fastigio oppidum cingebant“, quo loco translate dicitur fastigium de summitate collium et montium.

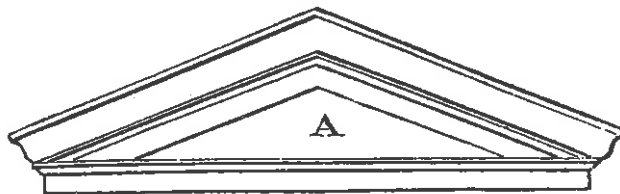

fastigium

A = tympanum

## favus —i, m.

est locus, quem apes fingunt multicavatum e cera, cum singula cava sena latera habeant, quot singulis pedes dedit natura.

Cicero, off. 1, 44, 157:

„apium examina non fingendorum favorum

causa congregantur, sed cum congregabilia naturā sint, fingunt favos.“

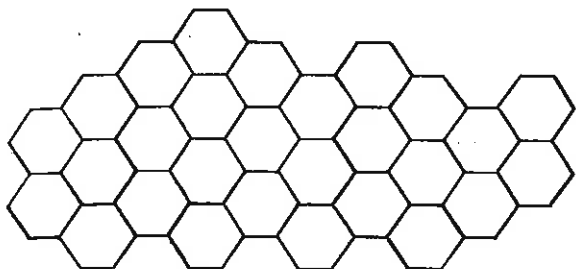

### fax -cis, f.

est frustum ligni ut pinus, taedae, laricis cerā aut oleo iniunctum, aut etiam per se solum, vel alterius materiae igni concipiendo aptae, ad lumen faciendum ignemque circumferendum, frequenti usu praesertim apud rusticos.



### feles -is, f.

est animal quadrupes domesticum, acutis unguibus, mirā velocitate, oculisque etiam noctu cernentibus praeditum, muribus et avibus infestissimum.

adi.: felinus, -a, -um

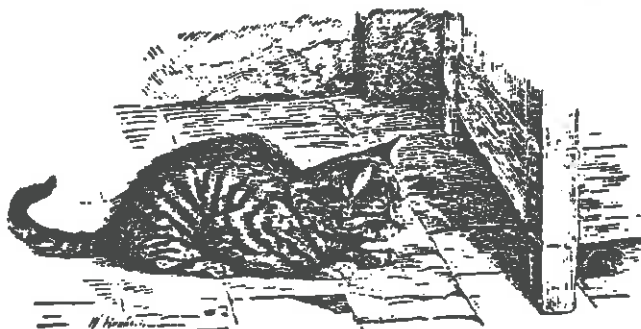

### ferculum -i, n.

a) a verbo „fero“, est machina ferendo apta.  
b) est gestamen, quo signa (*signum*) deorum in pompa circensi vehebantur, aut quo in triumphis spolia hostium, simulacra oppidorum captorum aut regionum portabantur.



ferculum in triumpho latum

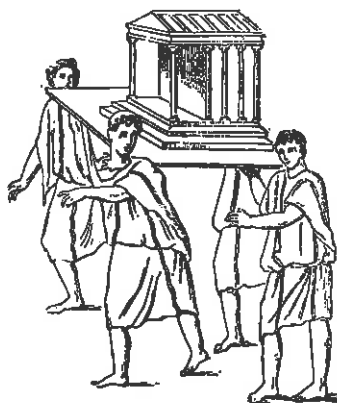

ferculum in pompa deorum portatum

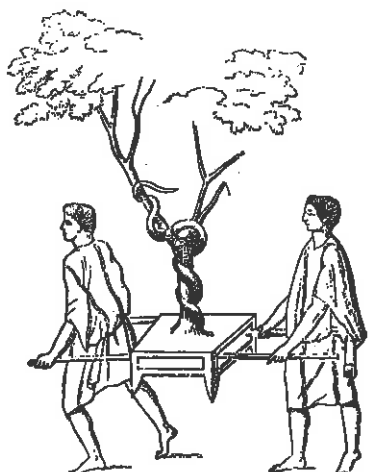

**Ianuarus.**

1. Kalendae Ianuariae.
2. Dies Aegyptiacae.
9. Agonalia.
11. 15. Carmentalia.
- 22.—24. Ludi Palatini.
24. Paganalia.
25. Sementina.
27. Dedicatio aedis Castorum.

**Februarius.**

- Neptunalis.
13. Faunalia.
- 13.—21. Dies parentales.
15. Lupercalia.
17. Quirinalia.
21. Feralia.
22. Caristia.
23. Terminalia.
24. Regifugium.
27. Equiria.

**Martius.**

1. Matronalia.
6. Festum Vestae.
14. Equiria.
15. F. Annae Perennae.
16. Mamuralia.
17. Liberalia.
- 19.—23. Quinquatrus.
23. Tubilustrium.
- 22.—27. F. Magnae Matris et Attidis.
25. Hilaria (cf. 3. Nov.).

**Aprilis**

- 4.—10. Megalesia.
- 12.—19. Ludi Cereris (Cerealia).
15. Fordicidia.
21. Parilia.
23. Vinalia.
25. Robigalia.
28. Apr.—3. Mai. Floralia.

**Maius.**

1. Lalaria.
9. 11. 13. Lemuria.
12. Ludi Martis in Circo.
15. Dies Mercurii et Maiaae.
21. Agonalia.
23. Tubilustrium.
25. F. Fortunae publicae.
29. Ludi Honoris et Virtutis.

**Iunius.**

1. Dies Iunonis Monetae.
- Dies Carnae.
- Dies Tempestatis.
5. Dius Fidius.
8. F. Mentis et Intellectus.
9. F. Iovis Pistoris.
- Vestalia.
10. F. Fortunae virilis.
11. Matralia.
13. F. Iovis invicti.
- Quinquatrus minusculae.
20. D. Summani.
24. D. Fortis Fortunae.
27. D. Iovis Statoris.
29. D. Quirini.

**Iulius s. Quinctilis.**

6. 14. F. Fortunae muliebris.
- (5) 6.—13. Ludi Apollinares. (14.—19. Mercatus.)
7. Nonae Caprotinae.
8. F. Vitulae, Victoriae.
15. Ludi Castorum.
- 20.—30. Ludi Victoriae Caesaris.
23. Neptunalia.
25. Furrinalia.

**Augustus s. Sextilis.**

1. F. Spei et Martis.
5. F. Salutis.
13. F. Dianae.
15. F. Astraeae.
21. Consualia.
23. Volcanalia.
25. Opiconsivia.
27. Volturnalia.
28. F. Victoriae.
30. Mundus patens (cf. 5. Oct. et 7. Nov.).

**September.**

1. Natalis Telluris.
- 4.—19. Ludi Romani (L. R. magni).
13. Clavus figendus. F. Cereris.
20. Natalis Romuli.
23. Natalis Augusti.
27. F. Fortunae reducis.

**October.**

4. Mundus Cereris.
5. Mundus patens.
6. Dies ater, Manibus sacer.
- 2.—12. Augustalia.
15. Ludi Capitolini.
19. Armilustrium.
23. F. Liberi patris et Liberae.
29. F. Vertumni.
27. Oct.—1. Nov. Ludi Victoriae Sullanae.

**November.**

1. (13.) Epulum Jovis.
3. Hilaria.
- 4.—17. Ludi Plebeii.
7. (8.) Mundus patens.
19. Lectisternia Cybeles.
22. F. Plutonis et Proserpinae.

**December.**

1. F. Fortunae muliebris (primigeniae).
5. Faunalia.
9. F. Junonis iugalis.
11. Agonalia.
15. Consualia.
- 17.—21. Saturnalia et Opalia.
23. Larentalia.
25. Natalis Solis invicti.



## fetialis —is, m.

fetiales erant sacerdotes vel legati populi Romani, quos penes rerum publice repetundarum, imperandae decessionis ex finibus, belli indicendi suscipiendique, et iungendorum foederum potestas erat et administratio.

Servius, ad Aen. 10, 14:

fetiales, „qui faciendis praesunt foederibus.“



## fibula —ae, f.

est quidquid rem unam adnectit, vel uni cum altera colligandae inservit. est instrumentum, quo vestes subnectuntur.

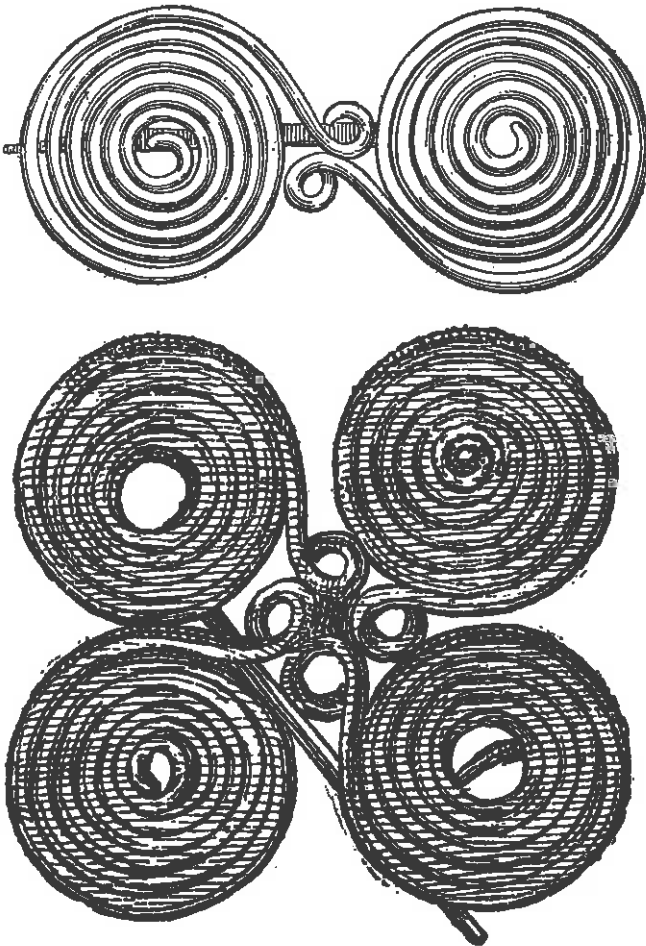

fibulae spiris ornatae

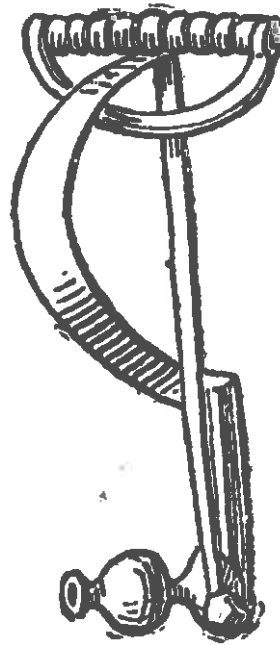

fibula arcuata

## fidicen —inis, m. (fidicina —ae, f.)

fidicen est is, qui fidibus canit; generatim dicitur pro citharista. usurpatur etiam pro poeta lyrico:

Horatius, *carm.* 4, 3, 23:

„Romanae fidicen lyrae“

fides, —ium, f. pl.

a) sunt chordae seu nervi lyrae.

b) fides dicitur instrumentum musicum, in chordis habens harmoniam (*lyra*, *cithara*).

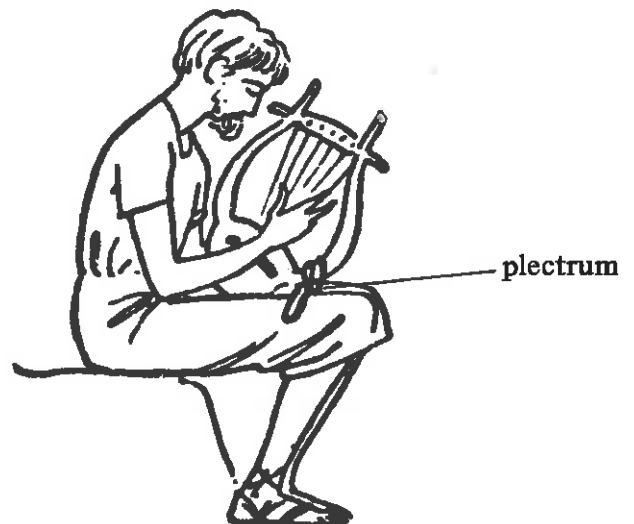

## filix –icis, f.

Plinius, H. N. 27, 78/9:

„filicis duo genera nec florem habent nec semen. ... folia utriusque lateribus pinnata.“

Horatius, sat. 1, 3, 37:

„neglectis urenda filix innascitur agris.“



## filum –i, n.

filum est quod ex lino lanave trahendo ducitur; itemque aliud quidlibet huic simile.

formula: filum in acum (*acus*) conicere.

a poetis filum saepe dicitur stamen vitae, quod nere *Parcae* dicuntur.

filum Ariadnae:

Ariadna, ut fabula narrat, Thesei amore capta, qui ab Atheniensibus ex foedere cum Minoe in Cretam Minotauro devorandus missus fuerat, ei arma et filum dedit, ut labyrinthi (*labyrinthus*) vias signaret et monstro interfecto incolumis evaderet.

## fiscus –i, m.

fiscus est vas vimineum, iunceum, aut ex simili materia. mos fuit pecuniam in fiscos condere:

Phaedrus, 2, 7:

„multos ferebat fiscos cum pecunia.“

fiscus dicitur etiam de ipsa pecunia, praesertim de pecunia publica.

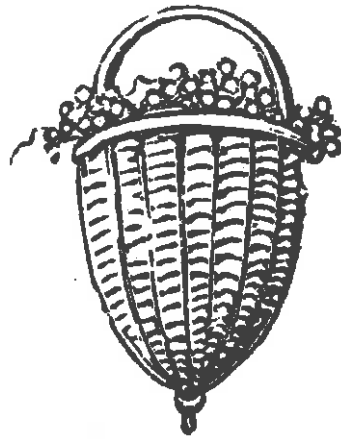

## flabellum –i, n.

deminutivus a nomine „flabrum“ = parvum flabrum, instrumentum, quo fit ventilatio ad refrigerandum, vel ad ignem excitandum.

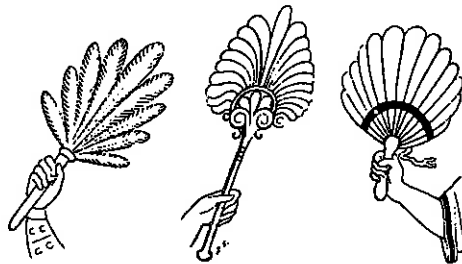

varia flabella e pennis facta

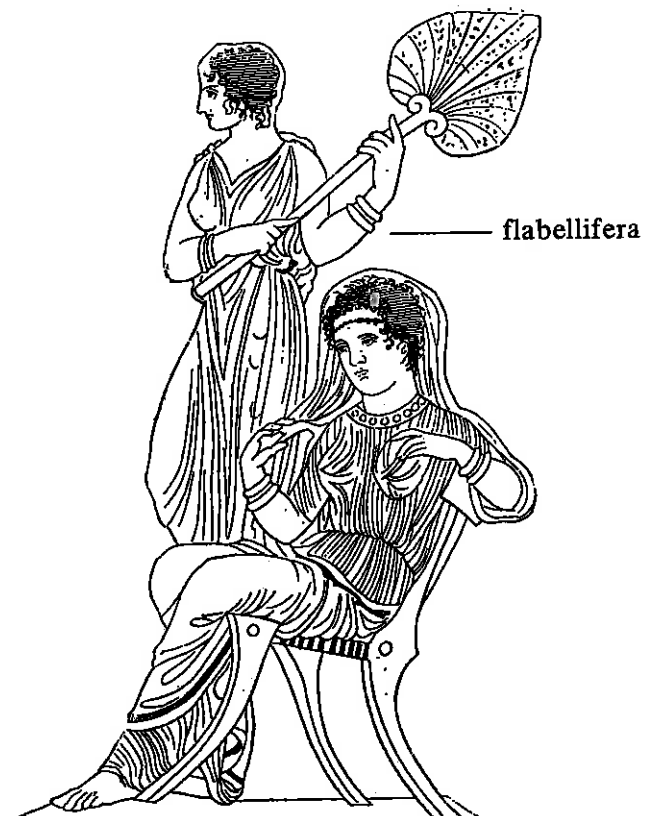

flabellifera

## flagellum -i, n.

deminutivus, a nomine „flagrum“, est lorum seu aliud quodvis flexile, verber, seu potius instrumentum pluribus loris iunctum, ac saepe scorpionibus sive aculeis munitum, quo servos nudatos caedere solebant.

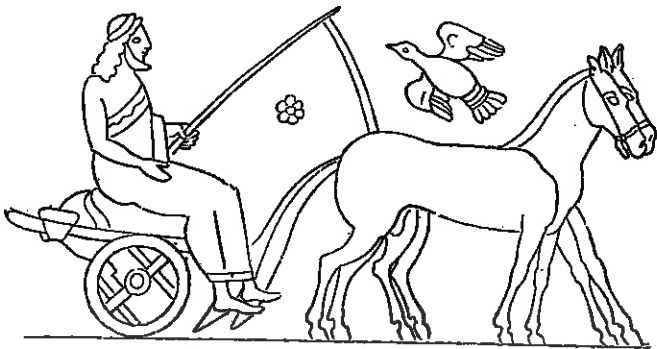
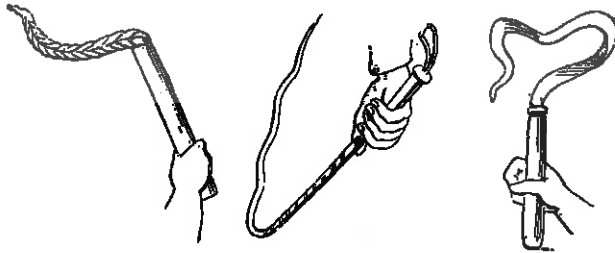

## flamen -inis, m.



apex  
pileus

laena

sacerdos apud Romanos. flamines appellabantur cognomine eius dei, cuius sacra curabant, ut flamen Dialis (= Iovis), Martialis, Quirinalis,

Floralis, Vulcanalis etc. suberantque omnes pontifici maximo.

flamen caput pileo cum apice tegebat, supra togam laenam purpuratam gerebat.

## foculus -i, m.

est parvus focus.

dicitur etiam de ara et de foculo, qui vel fictilis vel aeneus, vel argenteus, et duabus ansis (ansa) instructus circumferri solebat sacrificandi causa.

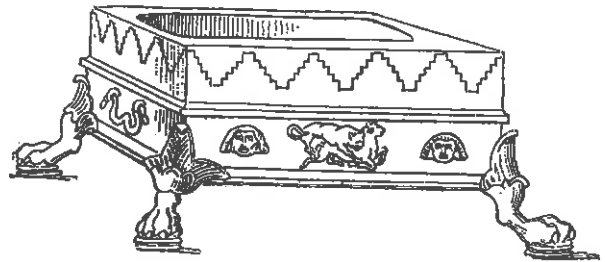

foculus qui portatur

focus aut foculus ponitur etiam pro vase ferreo, aeneo aut fictili, in quo cibi coquantur aut quo homines calefiebant.

Plinius, H. N. 35, 89 :

„Arrepto carbone extincto e foculo imaginem in pariete delineavit.“

## focus -i, m.



a) stricto sensu est id, quo ignis servatur, sive sit stabili loco in aedibus, sive qui possit quolibet circumferri.  
 b) speciatim de *ara*, seu potius de foculo (*foculus*), qui vel fictilis, vel aeneus, vel argenteus, et duabus ansis (*ansa*) instructus circumferri solebat sacrificandi causa. hinc saepissime

„*ara focusque*“ simul nominantur a Latinis scriptoribus.

Cicero, Nat. Deor. 2, 27, 67:

„vis autem Vestae ad aras focosque pertinet.“

c) focus sumitur etiam pro privata domo:

Horatius, Ep. 1, 14, 2:

*agellus ... habitatus quinque focus ...*

## folia aliquot arborum

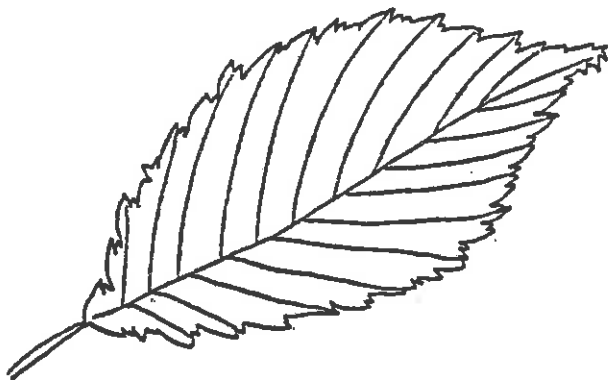

*Ulmus campestris*

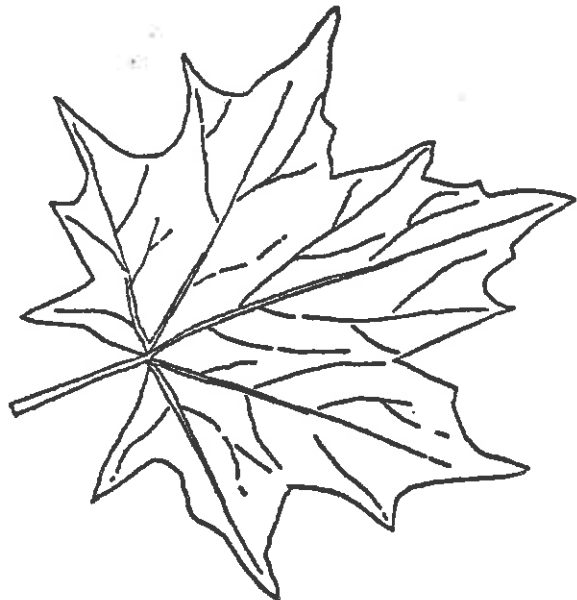

*Acer platanoides*

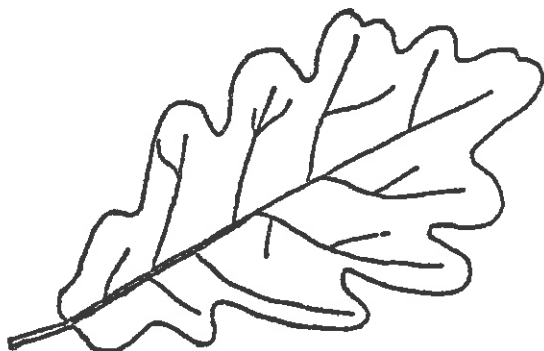

*Quercus robur*

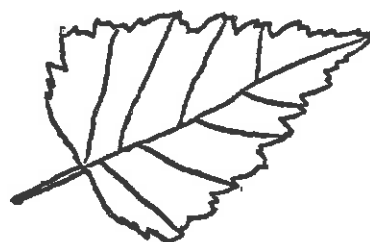

*Betula verrucosa*

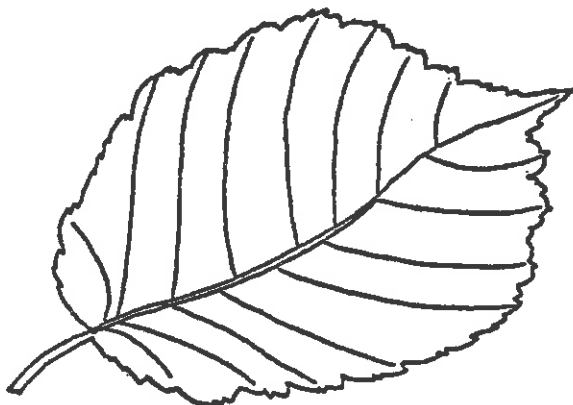

*Corylus avellana*

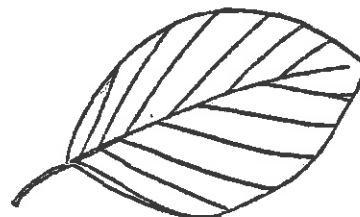

*Fagus silvatica*

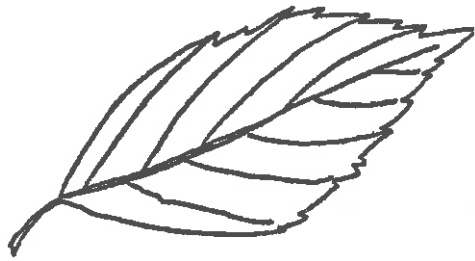

Fraxinus excelsior

**follis** —is, m.

a) est sacculus coriaceus, qui vento aliave re impletur. e quo follis dicitur instrumentum, quo attrahitur ventus atque emittitur ad ignem excitandum.

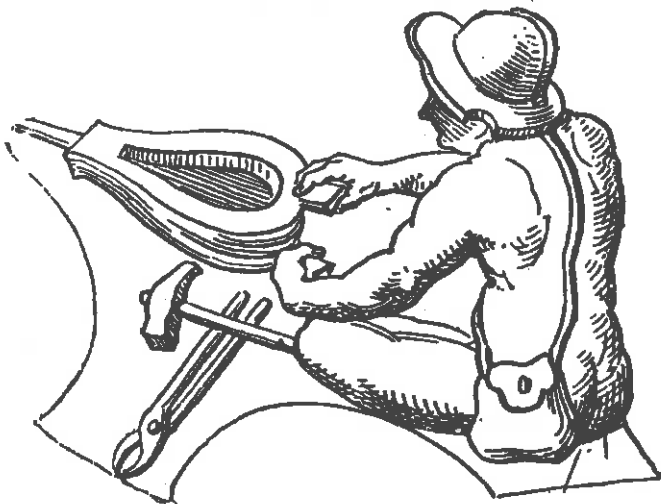

lucerna fictilis cuius ellyphnium folle excitatur

b) item est pilae (*pila*) genus omnium maximum, constans ex aluta vento inflata, quod etiam hodie Italis plurimo est in usu.

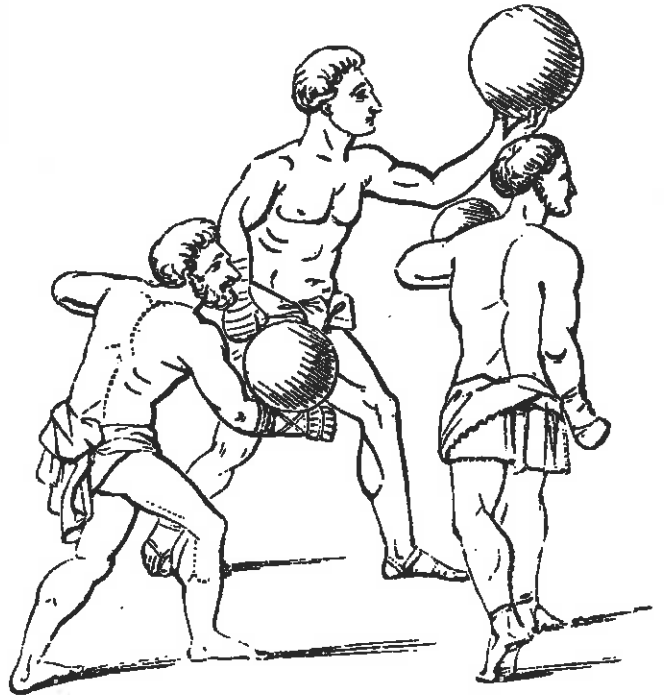

**fons** —ntis, m.

a) est locus, unde perennis aqua erumpit et ipsa aqua iugis erumpens.

Cicero, Verres 4, 53, 118:

„fons aquae dulcis, cui nomen Arethusa est, incredibili magnitudine, plenissimus piscium.“



b) fons dicitur ipsa constructio fabricae, unde aqua profluit.

c) fons per metaphoram etiam est origo, principium, causa, unde quippiam abunde suppetit.

Cicero, Acad. post. 1, 2, 8:

„meos amicos, in quibus est studium, ad Graecos ire iubeo; ut ea a fontibus potius hauriant, quam rivulos consectentur.“

### forceps –cipis, f.

est instrumentum fabrum ferrariorum, chirurgorum aliorumque, ad aliquid capiendum retinendumque.

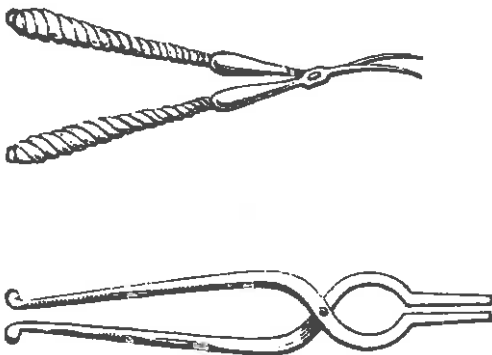

Vergilius, Georg. 4, 175:

Cyclopes „versantque tenaci forcipe ferrum.“ in machinā tractoriā forceps est ferramentum cuneatum (*cuneus*), quod oneri infixum apprehendit et continet.

Vitruvius, 10, 2, 2:

„... ferrei forcipes religantur, quorum dentes in saxa forata accommodantur.“

### forfex –icis, f.



est instrumentum ferreum, quo filum, telam, pannos et alia huiusmodi incidimus.



### forma –ae, f.

forma est exemplar alicuius rei cavatum, in quod materies ad rem fingendam infunditur sive imprimitur.

Columella, 7, 8, 7:

(caseus) „vel manu figuratur vel buxeis formis exprimitur.“

Plinius, H. N. 35, 153:

„cerā ... in eam formam gypsi (sc. ex ipsā facie hominis expressam) infusā ...“



statua



forma statuae

## formīca –ae, f.

formīca est exiguum animal, sed admirabilis sollertiae, aestate congerens et condens sub terrā, quae hieme victui sint. (*horreum*).

Phaedrus, 4, 24, 17ss: formīca ad muscam: „nihil laboras? ideo, cum opus est, nil habes. ego grana in hiemem cum studiose congero te circa murum pasci video stercore.“



- 1 regina
- 2 formīca operaria
- 3 mas

## fornax –acis, f.

in fornacibus coquuntur vasa fictilia, figurae fictiles, metalla in fornace aerariā, calx in fornace calcariā.

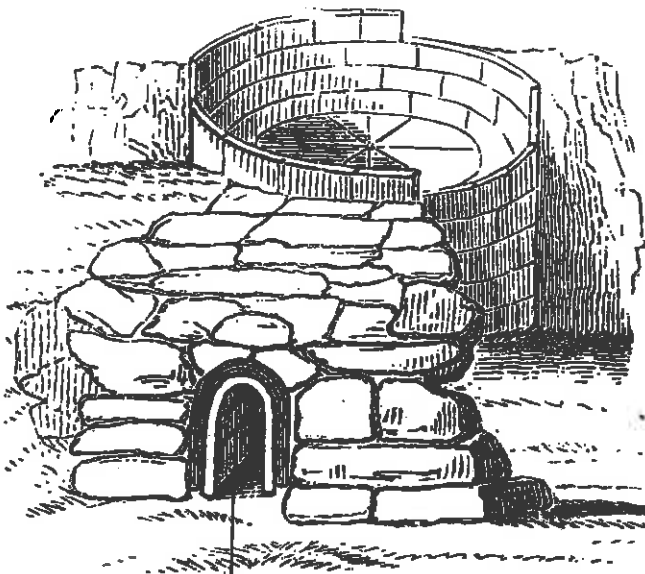

praefurnium

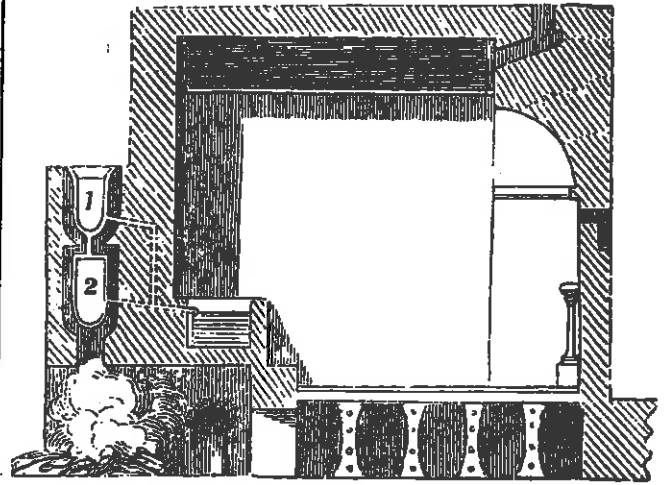

fornacula

hypocaustum

fornacibus aut fornaculis etiam calefiunt hypocausta balneorum (*balneum*) domuumque.

## fornix –icis, f.

a) est structura in arcūs modum curvata et convexa, quae plures arcus complectitur, quemadmodum est etiam *testudo*, quae fuit quaedam *camerae* species.

b) per similitudinem fornices dictae sunt *cellae* concameratae, vel *pergulae*, in quibus prostabant meretrices. verbum derivatum: fornicari = scortari.

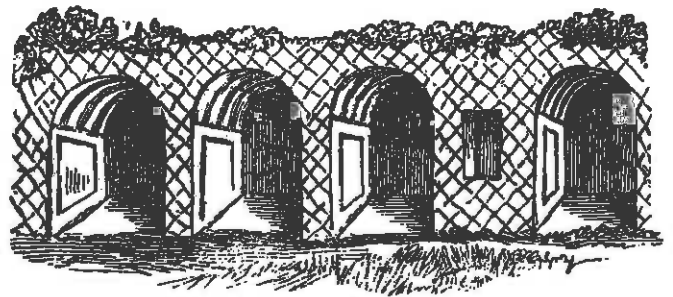

## Fortuna –ae, f.

dea est fati humani, quod saepe rotae assimilatur. rota Fortunae refertur ad varietatem instabilitatemque Fortunae, quae rotae insistere dicitur.

Tibullus, 1, 5, 70:

„versatur celeri Fors levis orbe rotae.“ (*rota*)

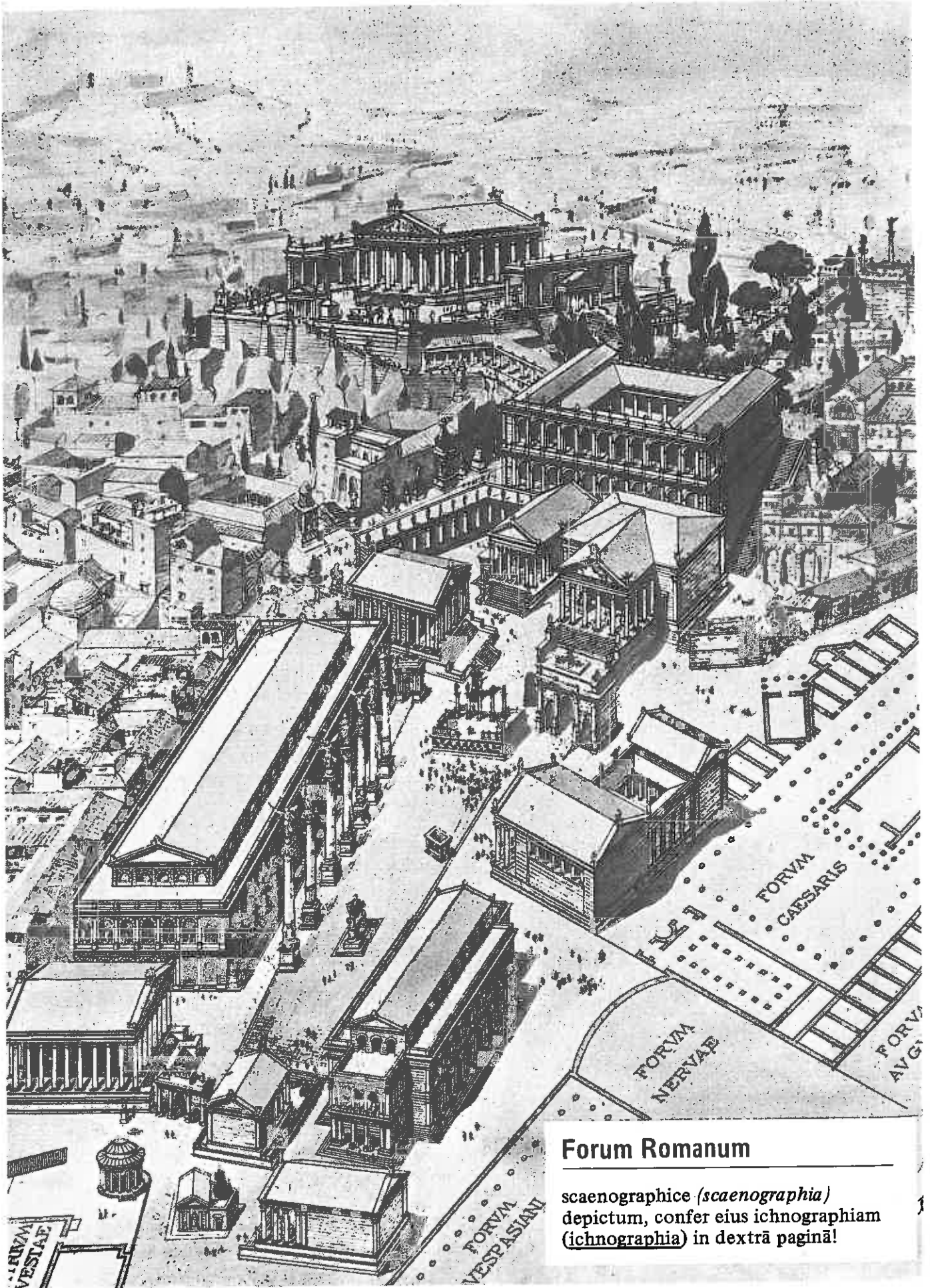

## Forum Romanum

scaenographice (*scaenographia*)  
depictum, confer eius ichnographiam  
(*ichnographia*) in dextrā paginā!



forum —i, n.

forum est locus spatiosus in urbe, in quo res venduntur, negotia fiunt, unde forum boarium, olitorium, cuppedinis, piscarium, vinarium. etiam forum dicebatur locus, quo populus conveniebat, in quo iurisdictio exercetur, contiones habentur ad populum, causae aguntur.

forum Romanum fuit omnium ornatissimum propter aedificia et frequentissimum propter iudicia, inter colles Palatinum et Capitolinum situm. ibi sunt curia, rostra, comitium, *tabernae argentariae*, *porticus* circa columnis nixae, *basilicae*, *templa* magna etc.

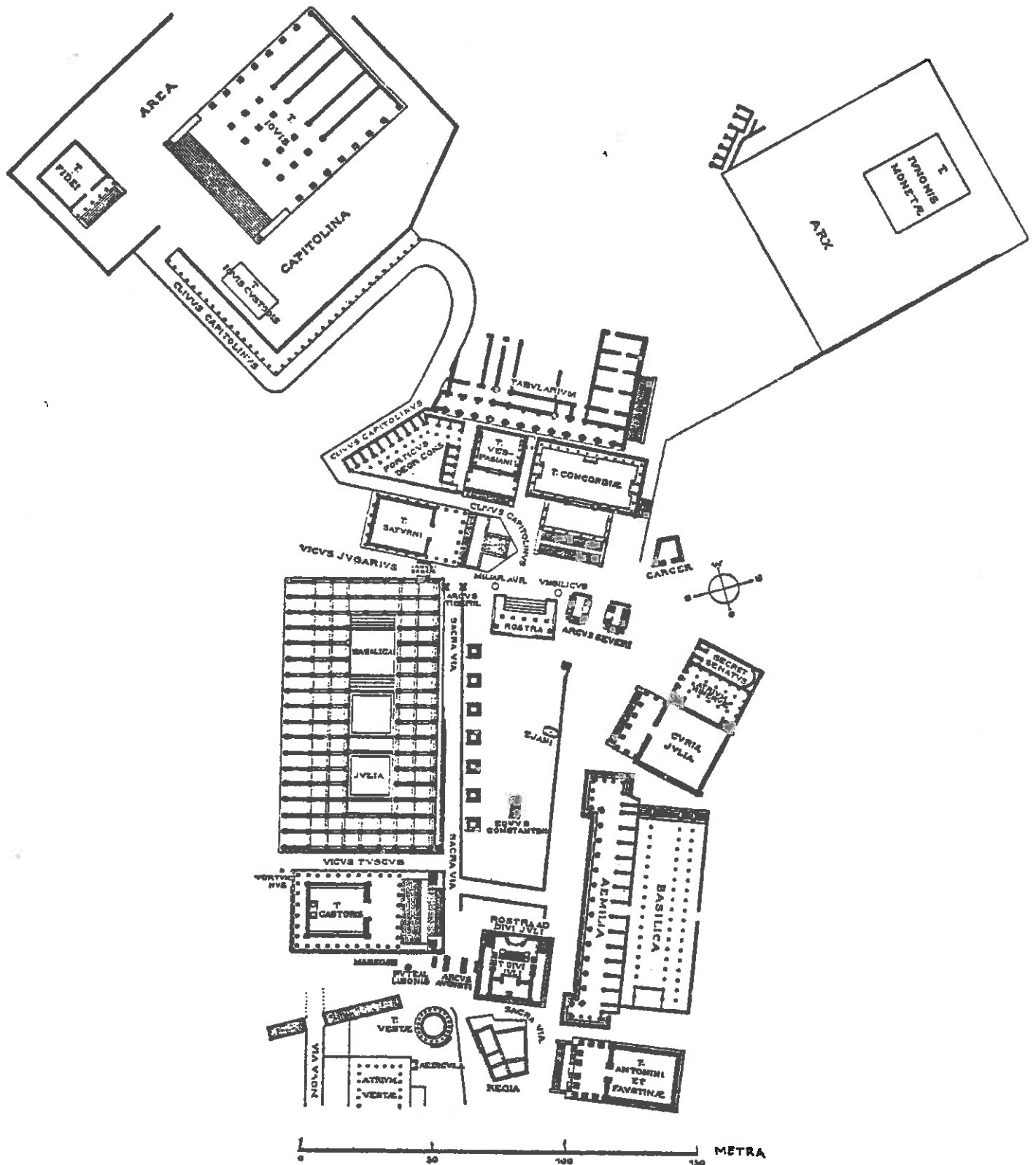

ichnographia fori Romani. confer *scaenographiam* in sinistrā parte!

## fovea –ae, f.

fovea est fossa brevis, profunda et in summo tantum patens: quales sunt, quibus fronde obtectis, bestias feras decipiunt, et quibus sepeliuntur cadavera.

Horatius, Ep. 1, 16, 50:

„cautus enim metuit foveam lupus ...“

dictum: „paene in foveam incidi“ = paene in periculo perii.

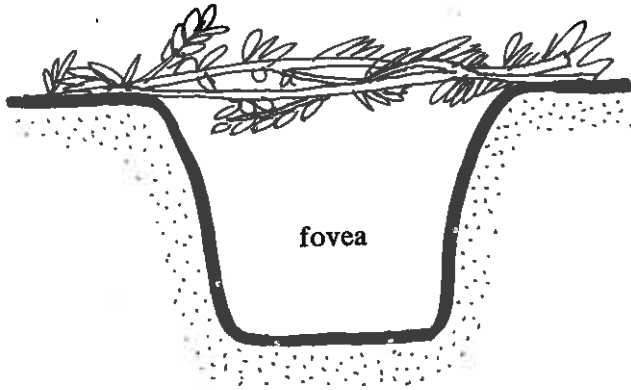

## frenum –i, n.

frenum est instrumentum, quo equorum ora coercentur; lorum freno alligatum, quo equi reguntur, *habena* dicitur.

Horatius, Ep. 1, 10, 36:

„imploravit (equus) opes hominis frenumque  
recepit.“

proverbium: „frenum mordere“ est se ferocem et recusantem ostendere.

verbum: frenare = frenum imponere.

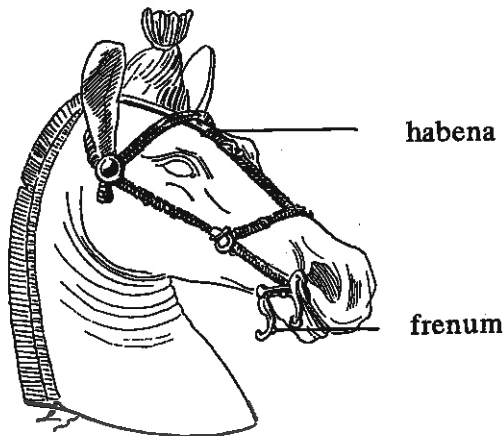

## fretum –i, n.

a) sunt maris angustiae, e. g. fretum Siciliense, inter Siciliam Italiamque situm; fretum Gaditanum est fretum nostri maris et Oceani.

b) speciatim absolute dicitur de freto Siculo, quod primum omnium fuit Romanis cognitum et maxime frequentatum.

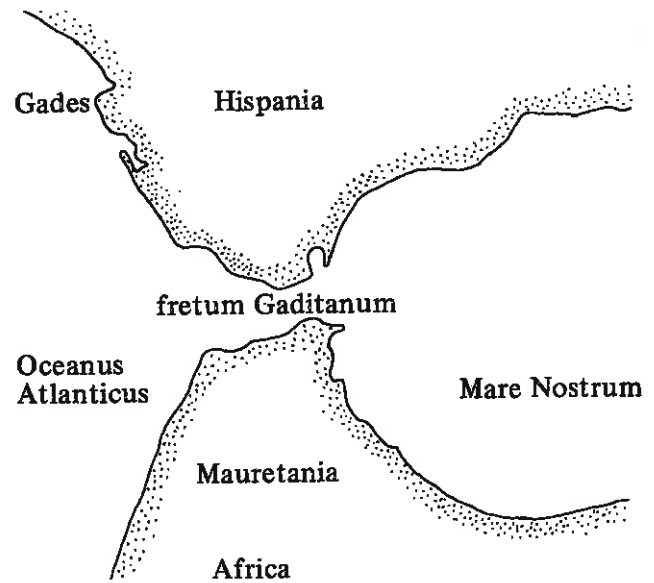

## frigidarium –i, n.

est primum conclave balnei (*balneum*) Romani aut thermarum (*thermae*) prope *apodyterium*, aquā frigidā praeditum, ubi post sudationem intrabant. saepe in frigidario *piscina* frigida erat, quae *baptisterium* vocatur.



sectio frigidarii Thermarum Diocletiani. Hodie in hoc frigidario est ecclesia, a Michel Angelo exstructa, quae Sancta Maria Angelorum (italiane: degli Angioli) nominatur.

## fritillus —i, m.

est turricula rotunda, per quam tali mittuntur, ne digitis ita a quoquam componi possint ut cadant ad iacentis voluntatem: qui fritillus intus trochleatim erat effectus, certosque habebat excisos gradus, quibus tali (*talus*) impingentes subsilirent cum sonitu.

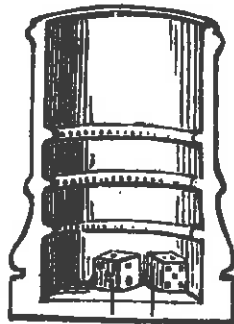
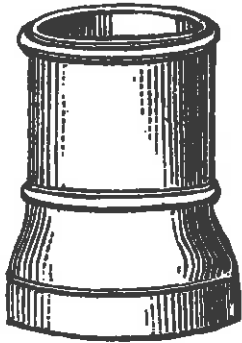

tali

## frontispicium —ii, n.

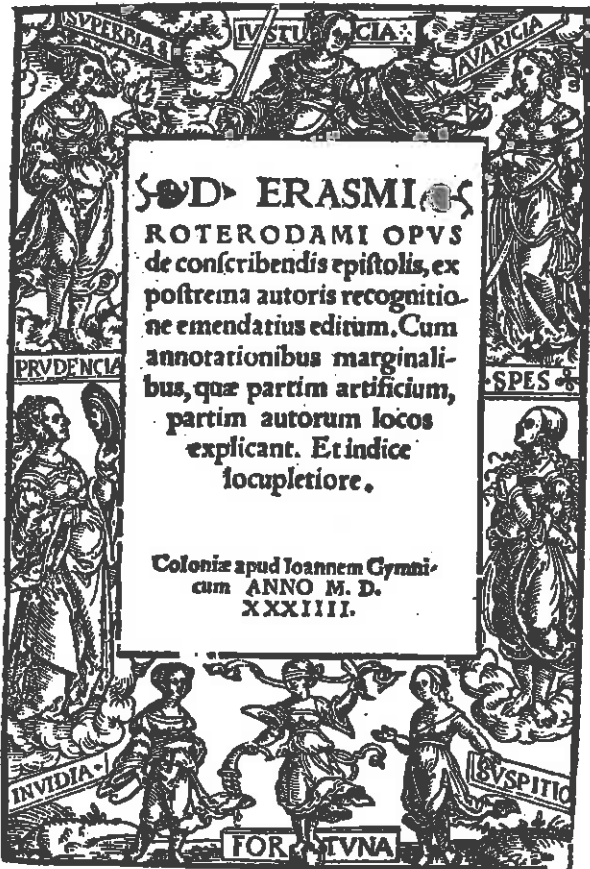

frontispicium operis Erasmi Roterodami de conscribendis epistolis

a) mensae speciosae quaedam pars, quae Graece vocatur kymation.

b) frons est aedificii.

Ps. Prosp. prom. 3, 38, 44:

„titulus aeneis grandioribusque litteris in frontispicio templi conscriptus.“

c) \*\*\* est imago xylographica vel aeri incisa titulum libri illustrans vel in ipsā tituli paginā vel in paginā titulo adiacente. (*xylographia*)

## fucus —i, m.

a) est color purpuram imitans. quicumque color non sincerus et naturalis, sed facticius et arte inductus ad verum imitandum, qualis est v. gr. quo mulieres faciem tingunt ad augendam pulchritudinem.

Plautus, Most. 275:

„vetulae, edentulae, quae vitia corporis fucocculunt.“

formula: fucocillinare aliquid.

b) fucus dicitur de quovis ornamento extrinseco, levi, simulato, et in speciem quidem pulchro, sed quod facile apprehendatur.



## fullo –onis, m.



est qui vestes pedum insultu cogit et densat, easdemque purgat, maculis liberat, polit et creta candefacit.  
fullonica, –ae, f. aut fullonium est officina fullonis.

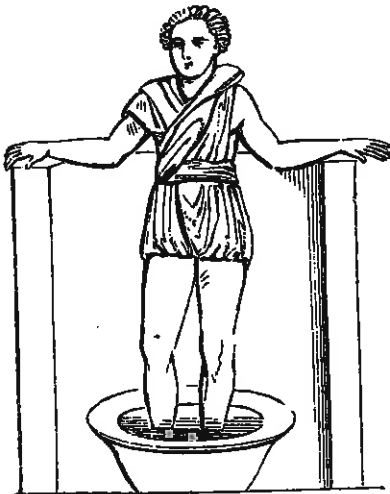

## funale –is, n.

est funalis cereus, seu funis pice, sebo, vel cera illitus.

Vergilius, Aen. 1, 727:  
„... et noctem flammis funalia vincunt.“



Victoria in imagine sepulcrali duo funalia ostentans

## funalis

sc. equus sub curru dicitur, qui non ad iugum sed ad latera iungitur, duobus iugalibus mediis: qui non iugo sed fune lorove alligatur.

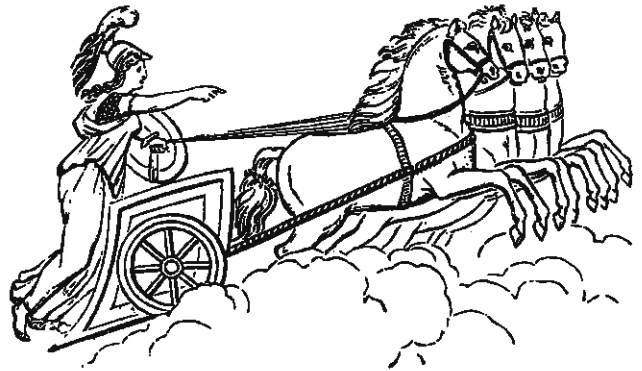

equus funalis (dexter) in quadriga Herculanseni

## funambulus –i, m.

est qui per funem ambulat.

Suetonius, Galba 6:

„novum spectaculi genus, elephantos funambulos edidit.“

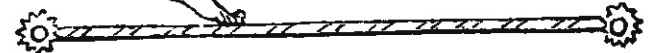

funambulus in pariete Herculanei depictus

## funda –ae, f.

est instrumentum e duobus funiculis, latiore sinu in medio, in quo lapis vel plumbea glans imponitur, circumactisque circum caput funiculis, et altero eorum remisso, magna vi longissime iacitur.

Caesar, B. G. 4, 25:

„ad latus apertum hostium constitui atque inde fundis, sagittis, tormentis hostes propelli ac summoverti iussit.“



funda

funditor in  
columna  
Traiani

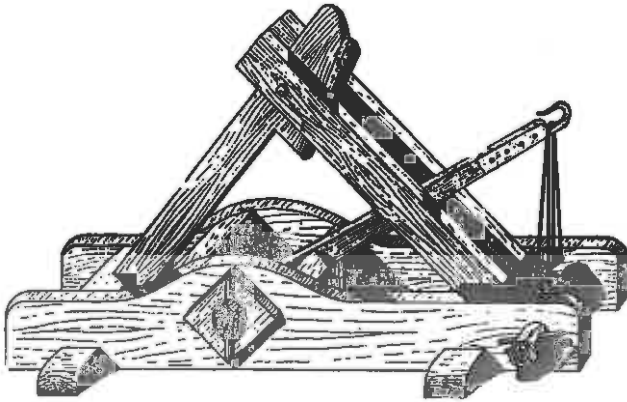

funda librilis est machina bellica, qua librilis saxa iaciebantur

funus —eris, n.



est pompa, quae fit in exsequiis mortuorum, a funalibus (*funale*) sive funibus accensis, quia cadavera noctu efferebantur cum faculis (*fax*), propter sacrorum celebrationem diurnam. interdum dicitur de ipso corpore vitā functo, aut de ipsis Manibus et umbra mortuorum, ut imagine ex opere caelato sumptā monstratur. adi. funebris, —e = ad funus pertinens, ex. gr. epulum funebre, vestimentum funebre. funebria, —ium, n. sunt ipsa iusta funebria, seu funeris apparatus.

furca —ae, f.

furca est instrumentum bicornis, quo stramenta moventur vel feruntur.

proverbium: „naturam expellas furca, tamen usque recurret.“ (Horatius, ep. 1, 10, 24)



furnus —i, m.

est locus, in quo panis coquitur. latiore sensu est quidquid calefaciendo inservit.

Plautus, Cas. 309–311:

„... in furnum calidum condito, atque ibi torreto me pro pane rubido, hera.“

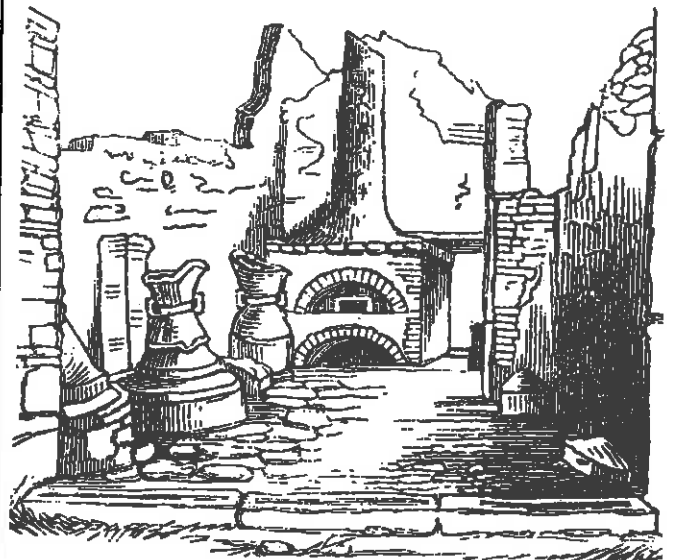

**fusus** -i, m.

est instrumentum, quod mulieres nendo (nēre, neo, nevi, netum) digitis volvunt.

Ovidius, Met. 6, 22:

„levi teretem versabat pollice fusum.“  
a poetis fusi tribuuntur Parcis (*Parcae*), quae nere dicuntur humanae vitae stamina (= fila).



imago in vase picto Graeco: puella pollice manus sinistrae fusum versat, dextra filum net

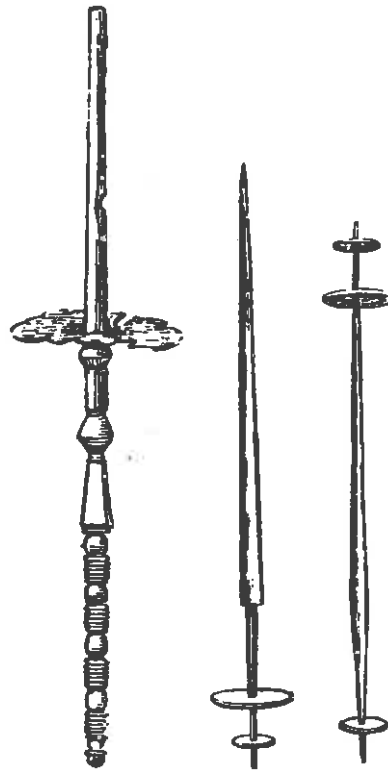

fusi aenei Romani

**galea** -ae, f.

cassis, tegumentum capitis ad munimentum in bellis contra ictūs et tela.

**cristatae galeae**, quae speciem magnitudini corporum adderent (Livius 9, 40).

(crista proprie est apex in vertice gallinae generis).

centuriones cristatas galeas portabant.

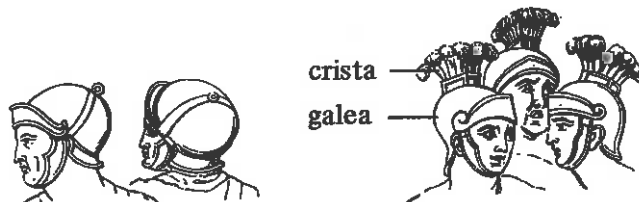

**Gallia Romana**

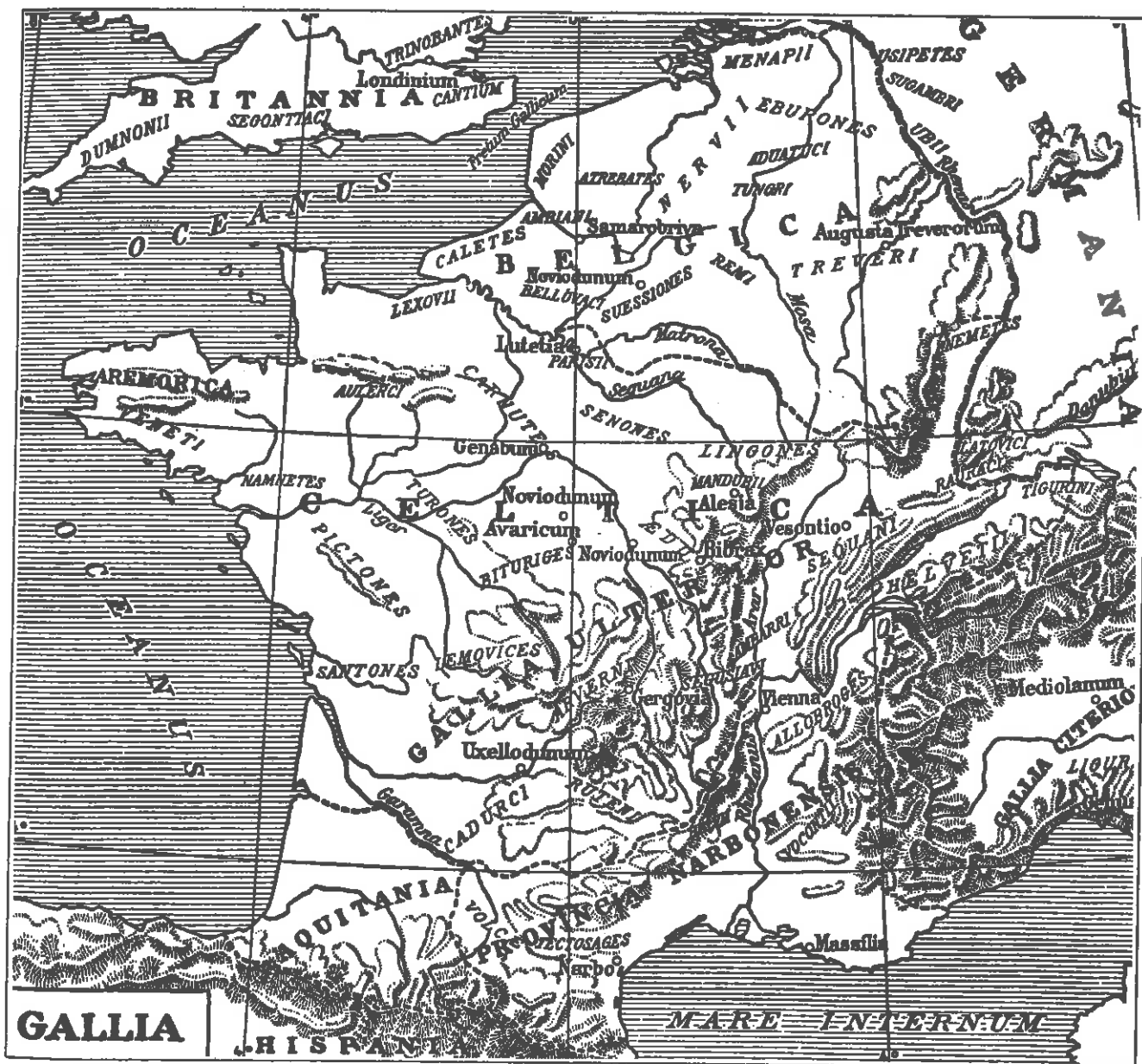

## gemma -ae, f.

a) gemma est oculus vitis vel alterius arboris, qui primo emittitur.

Columella, 4, 20, 5:

„vitis infirma ad duas gemmas recidenda est.“

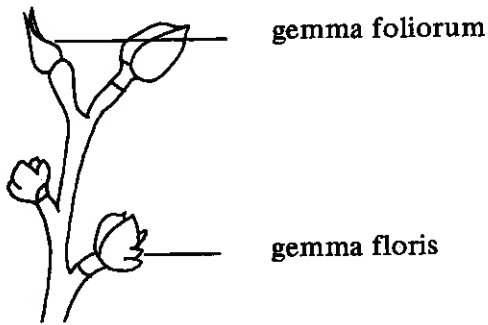

b) gemma dicitur etiam lapillus pretiosus materiae perlucidae velut smaragdi, chrysolithi, amethysti. interdum gemmae ab artifice insculptae erant.

Suetonius, Nero 46, 4:

anulus ...“ cuius gemmae sculptura erat Proserpinae raptus.“ gemma differt a margaritā, quae in conchis invenitur.

Plinius, H. N. 33, 70:

„e profundo maris petere margaritas.“



gemmae (sigilla) simbolo (symbolum) Christi praeditae

## gens -ntis, f. (gentium)

est multitudo hominum, quae ex pluribus familiis constat, quaeque ab eodem progenitore descendunt. sic omnes Corneliae unius esse gentis dicebantur, quia omnes uno appellabantur nomine, sed diversarum erant familiarum, quae cognominum varietate distinguebantur: gens enim Cornelia dividebatur in Cinnas, Dolabellas, Lentulos, Scipiones, Sullas etc.

adi. gentilis, -e est ex eodem genere ortus, seu qui est eiusdem gentis.

sequiore aeo gentiles a Romanis dicti sunt barbari, et quicumque non lege civili Romanorum, sed inculto iure gentium vivebant: gentilis opponitur vocabulo civilis, qui in civitatem receptus est. a Judaeis et Christianis gentiles nominabantur, qui non participes erant verae religionis. (pagus, paganus)

## geometria -ae, f.

lineae:

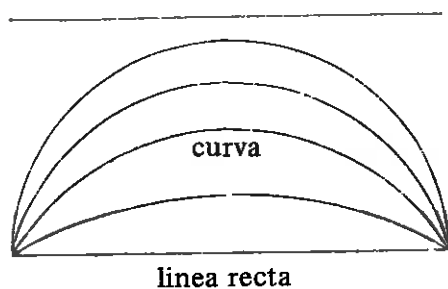

199

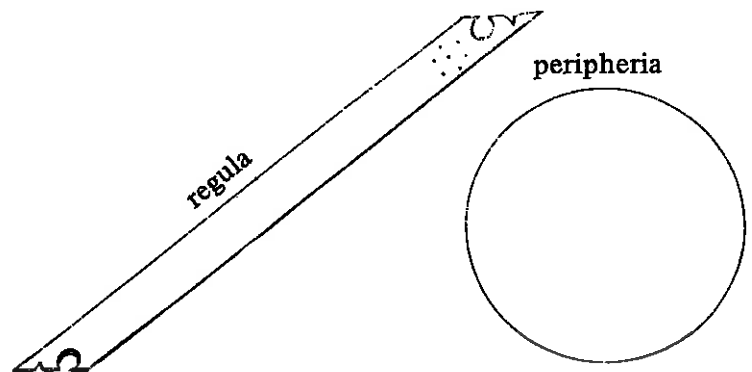

200



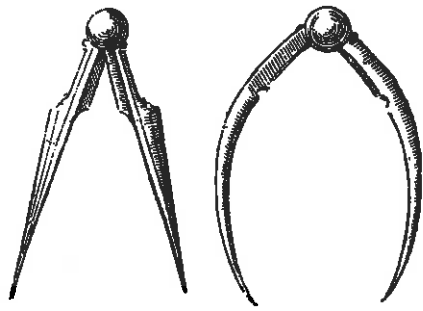

**circinus**

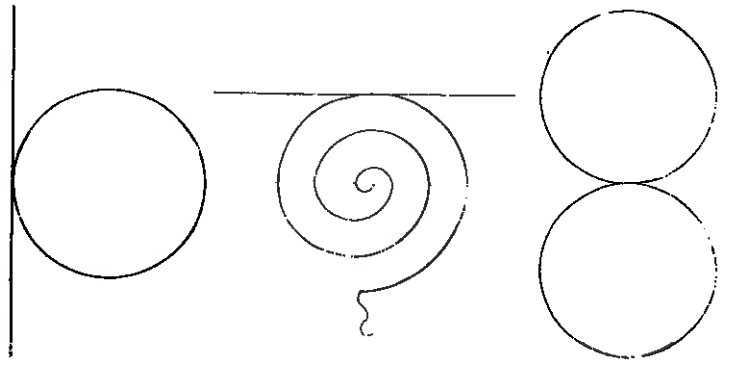

**tractus linearum**

**flexuosa**

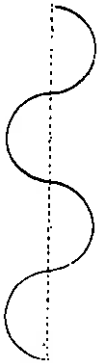

**conchalis**

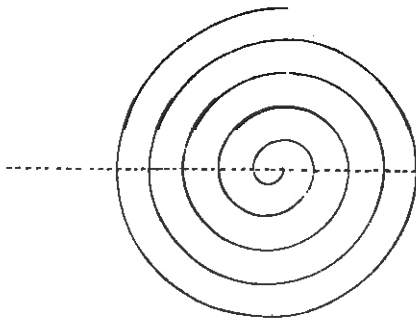

**ovalis**

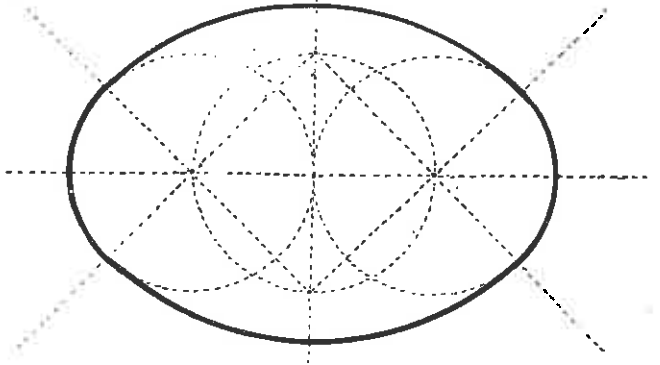

**ovalis**

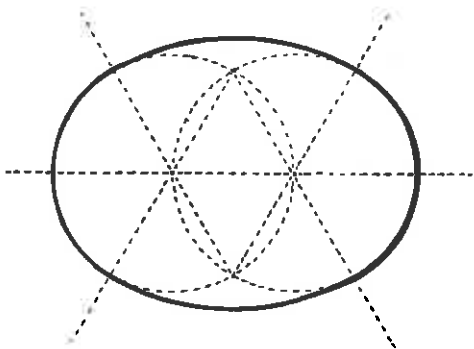

**vere ovalis**

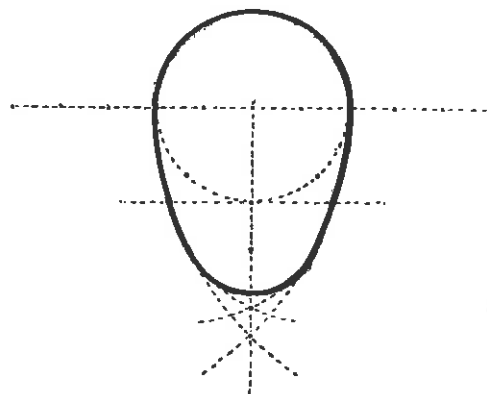

**perpendicularis**

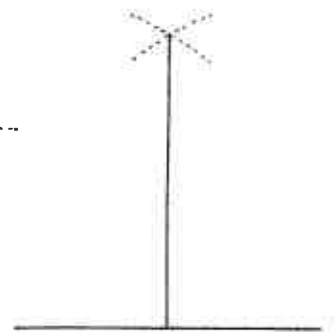

inclinata

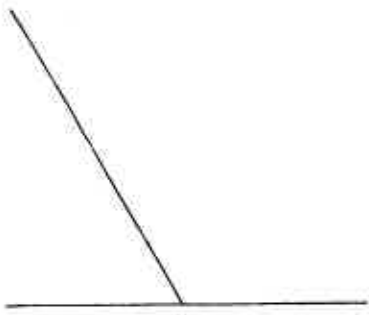

parallela

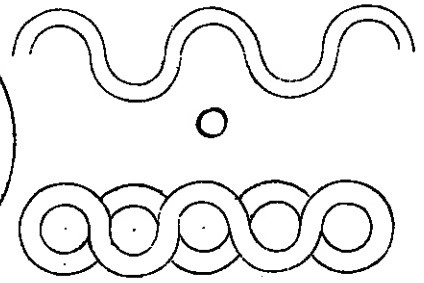
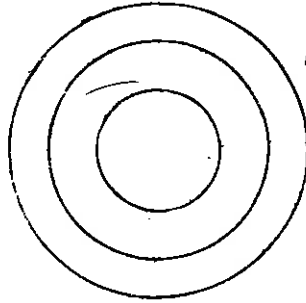

anguli:

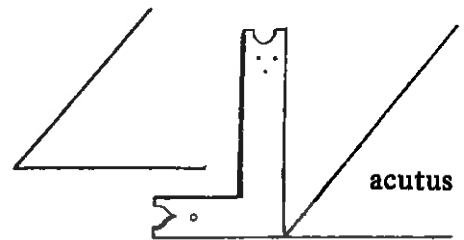
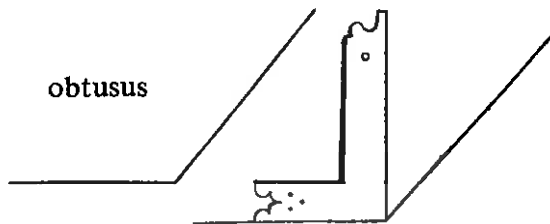
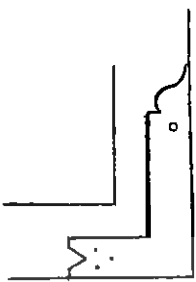
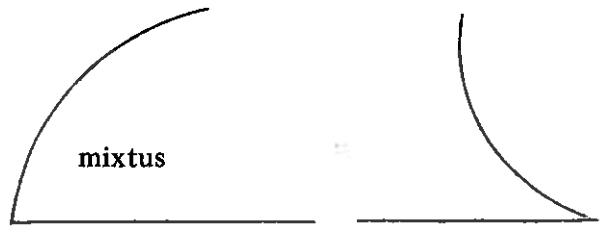
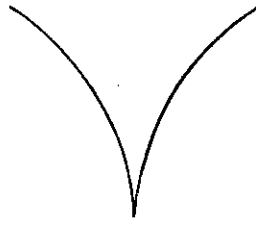
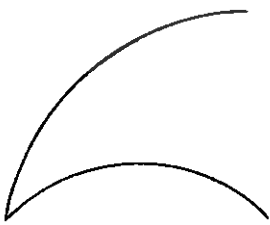
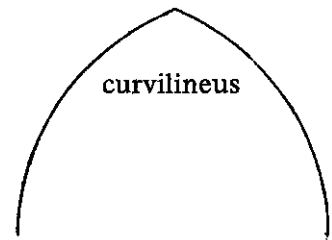
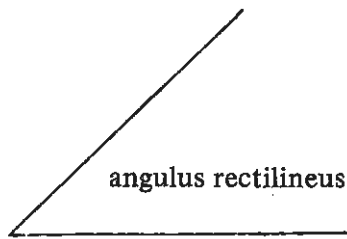
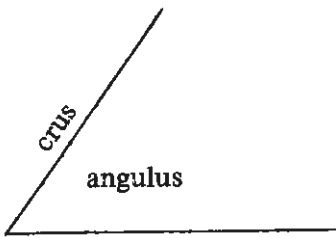

genera triangulorum:

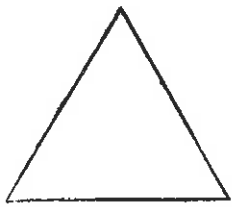

aequilaterum

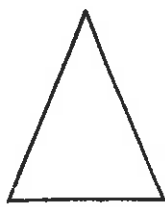

aequicrurum

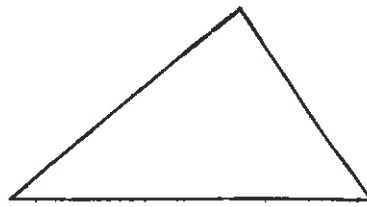

scalenum

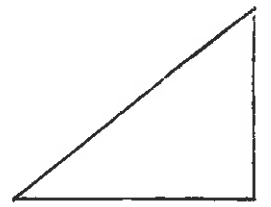

rectangulum

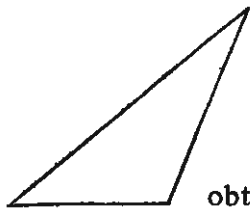

obtusangulum

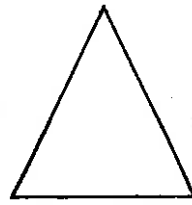

acutangulum

genera quadrangulorum:

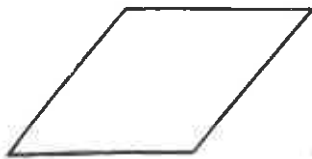

rhombus



rhomboides



oblongum

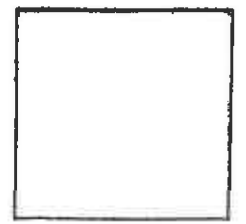

quadratum

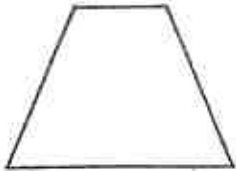

trapezium

circulus eiusque partes:

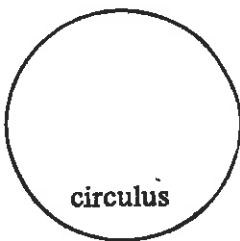

circulus

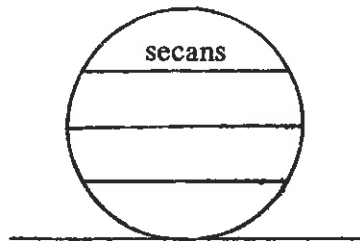

secans

tangens

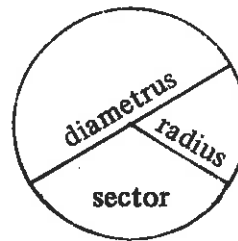

diameter  
radius

sector

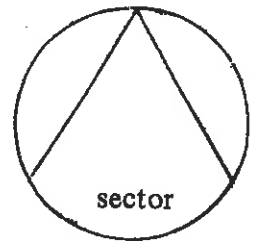

sector

peripheria



segmentum minus

segmenta similia



semicirculus

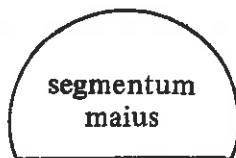

segmentum  
maius

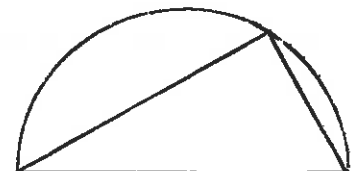

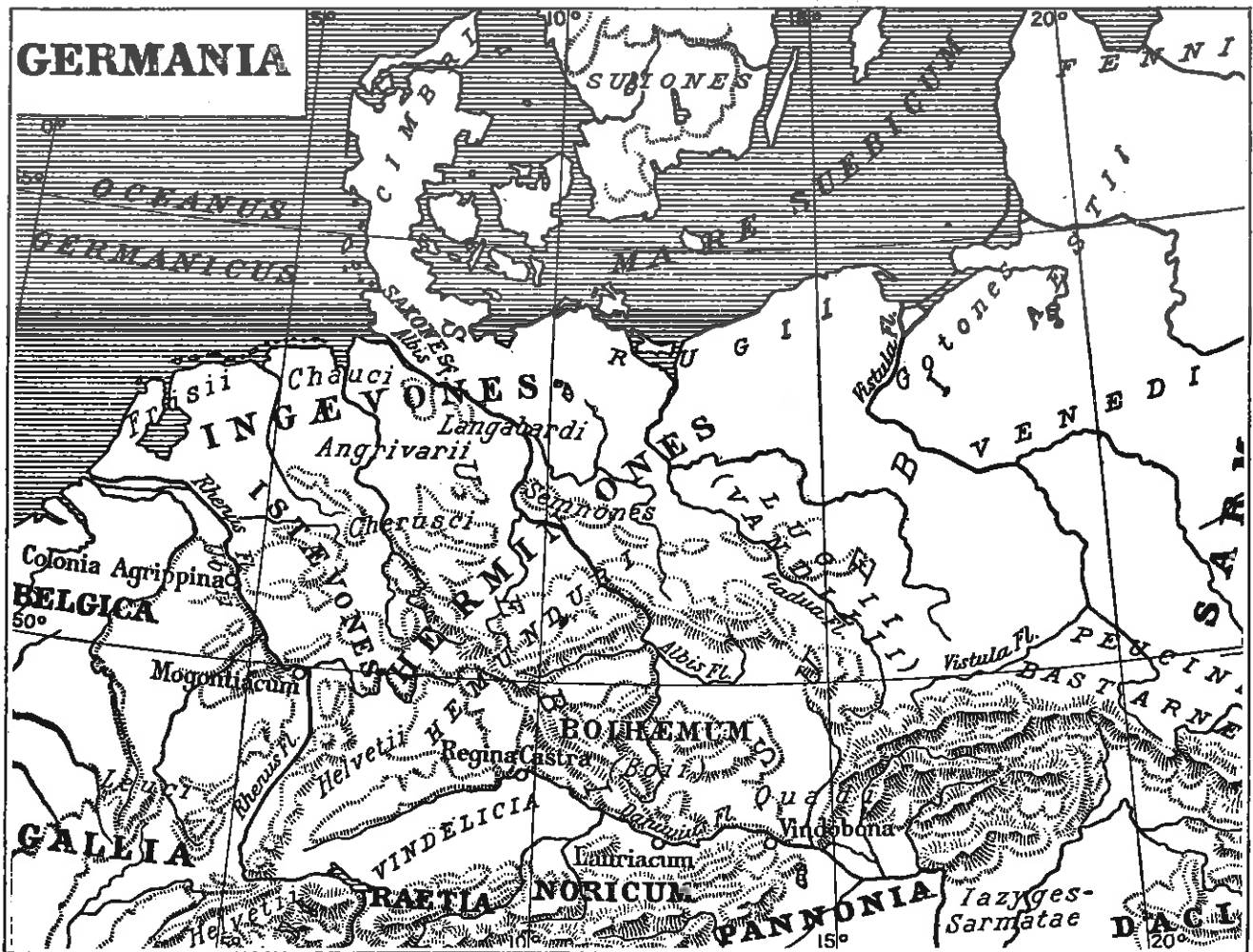

**gluten** —inis, n. vel glutinum, —i, n.

est materia viscosa ac tenax, qua res coniunguntur.

verba derivata: ad-glutino  
con-glutino

**glutinator**, —oris, m. est is, qui chartas chartis attegit in longitudinem, ut volvi possent et **volumen** efficere.

**\*\*graduale** —is, n.

a) **graduale carmen** est cantatum in gradibus (**gradus**) altaris (**altare**): carmen graduale vel psalmus gradualis.

b) **graduale volumen** vel **codex** est continens carmina missae dierum festorum. **codex** manu scriptus magnisque litteris notulisque musicis praeditus in pluteo (**pluteus**) exponebatur ut omnes cantores simul legere possent. (imago sumpta est ex Biblia Malermi)



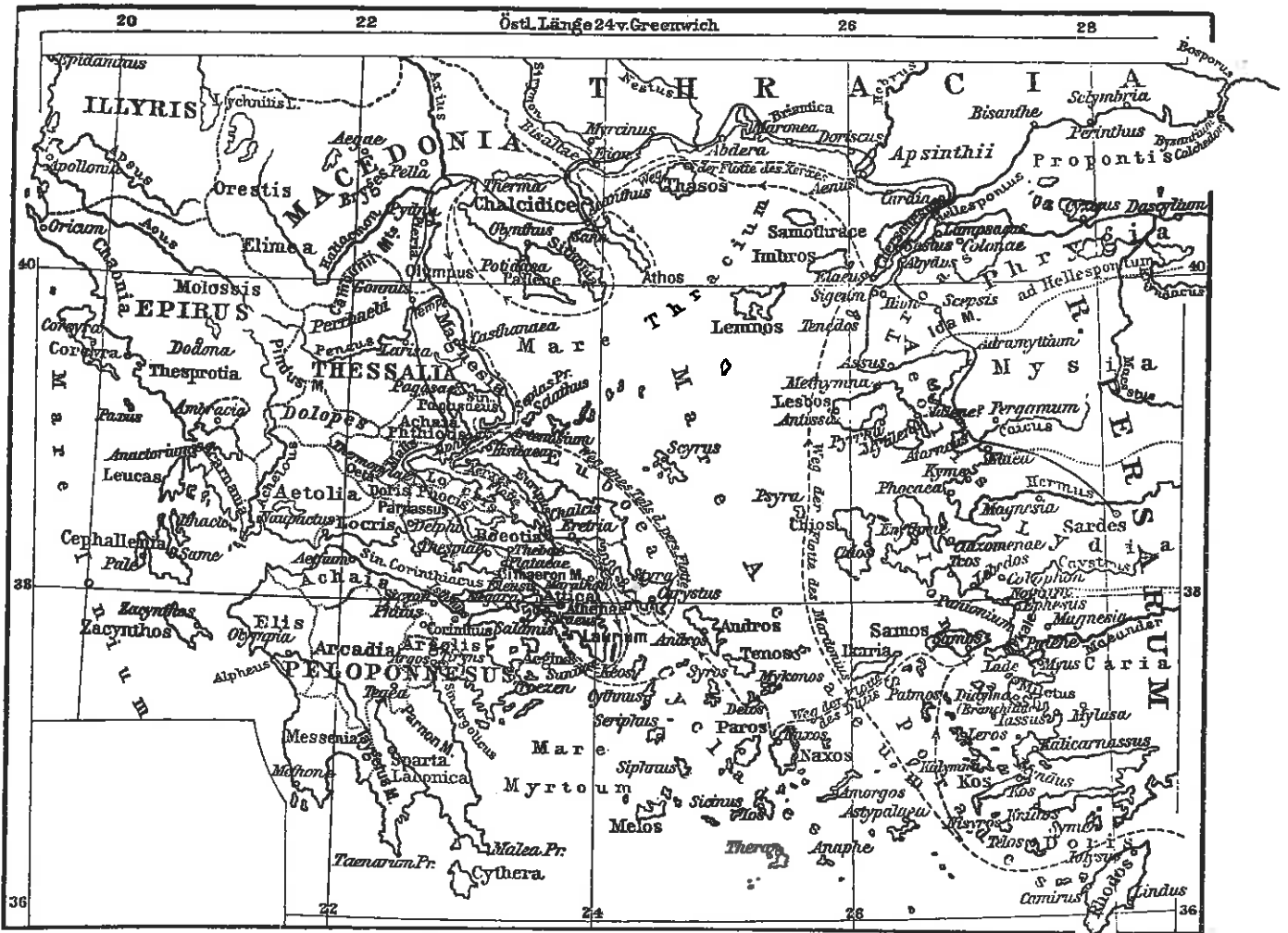

graphium —i, n.

graphium est stilus ferreus, quo veteres in ceratis tabulis solebant scribere; a graeco grapho = „scribo“.

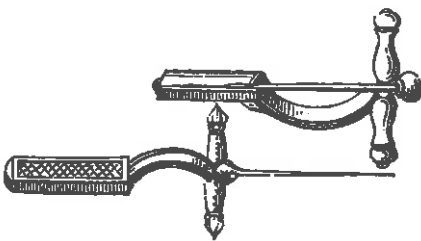

gremium —i, n.



gremium est locus inter complexum ventris et feminum, quem sedentes efficitur: quo loco matres nutricesque excipiunt infantes. differt a sinu (*sinus*), qui est intra pectus et brachia (sed nihilominus alterum pro altero non raro ponitur).

Cicero, Div. 2, 41, 86:

„puer in gremio matris sedens, mammam appetens.“

### gryps –pis, m. / gryphus –i, m.

est avis fabulosa, animal quadrupes et pennatum, omni ex parte leo, alis tantum et facie aquilae simile.

Plinius, Hist. Nat. 7, 10 narrat ex aliorum sententia, esse Arimaspos, homines uno oculo in fronte insignes, qui cum his bellum assidue gerant, eruentibus ex cuniculis (*cuniculus*) aurum, et mira cupiditate custodientibus, Arimaspiis vero rapientibus.

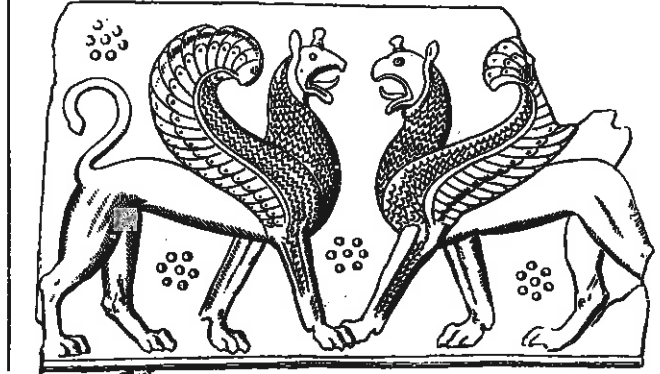

### gubernator –oris, m.

est rector navis.

Cicero Senect. 6, 17:

„gubernator clavum tenens, sedet in puppi quietus.“ gubernaculum est *clavus* in puppi navis, quo ipsa regitur.

Seneca, de gubernaculo, ep. 90, 24:

„exemplum (scilicet gubernaculi) a piscibus tractum est, qui cauda reguntur et levi eiusdem

in utramque momento velocitatem suam flectunt.“

vox „gubernator“ a Graeco *kybernetes* derivatur et saepe in vetustis monumentis „gybernator“ scribitur.

\*\*\*cybernetica (sc. ars) est ars automatariè regendorum motuum machinarum, inventa et denominata a Norberto Wiener.

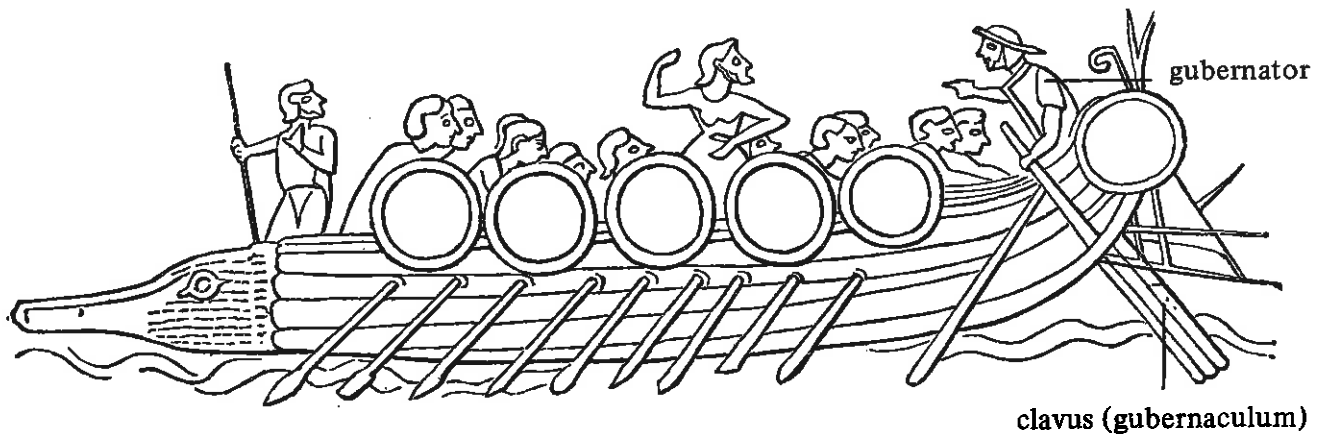

### gurgis –itis, m.

gurgis est locus in flumine profundus, in quo aqua vertitur (*vertex*), translate:

Cicero, Verr. 3, 23, 9:

Verres „... gurgis vitiorum turpitudinumque omnium.“

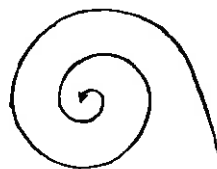

**gutta** -ae, f.

a) gutta est minima pars aquae vel alterius materiae liquidae.

Ovidius, Pont. 4, 10, 5:

„gutta cavat lapidem, consumitur anulus usu.“

b) in architectura guttae dicuntur ornamenta sub triglyphis in Dorico genere, instar guttarum pendentia.

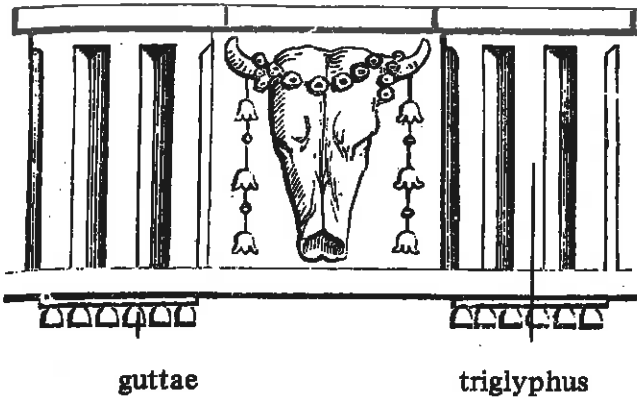

**gyrus** -i, m.

gyrus est circumventio in orbem, ambitus, circuitus, circulus.

\*\*\*gyrus est modus solvendi pecuniam non praesente pecunia, sed perscriptione factus.

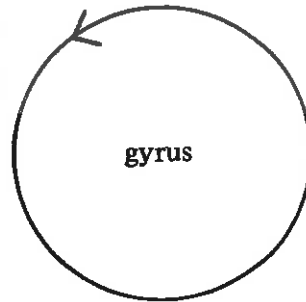

## habena –ae, f. (saepe: habenae, –arum)

habena est lorum freno (*frenum*) alligatum, quo equi reguntur.

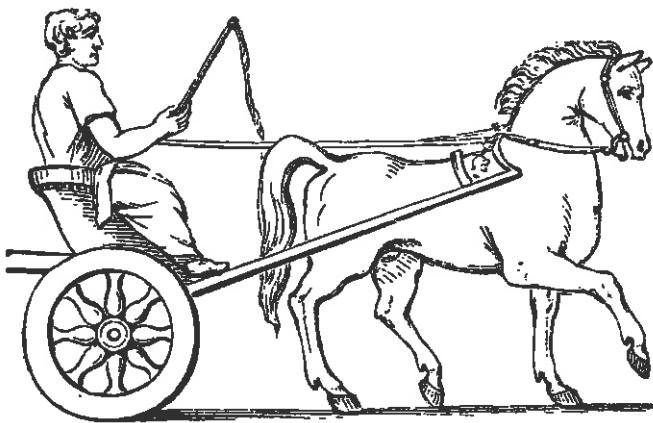

opus caelatum Musaei Veronensis

## hamus –i, m.

a) hamus est parvus uncus ferreus.  
b) speciatim hamus est uncus ferreus, ex quo piscatores (*piscator*) escam suspendunt, quam dum captat, piscis ore capiatur.

Ovidius, Heroid. 18, 13:

„Nunc volucrem laqueo, nunc piscem ducitis hamo.“

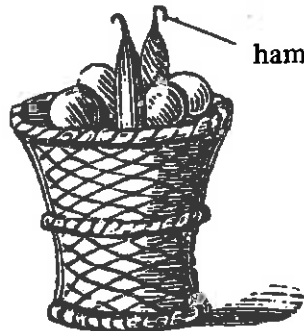

hamus textorius

## harpägo –onis, m.

est instrumentum ferreum, in fine aduncum, quo aliquid apprehenditur et deripitur attrahiturve, ad varios usus, praesertim bellicos; Latine etiam *manus ferrea* dicitur.

Caesar, B. C. 1, 57:

„hi manus ferreas atque harpagones paraverant.“



Livius, 30, 10, 16:

„asseret unco praefixi (harpagones vocat miles) ex Punicis navibus inici in Romanas coepti.“

## harundo –inis, f.

est aquaticus frutex in longam altitudinem crescens, cortice lignoso et inarescente, fissili, praeacutā semper acie. harundinibus veteres usi sunt ad casas (*casa*) contendas.

Vitruvius, 2, 1, 3:

„alii ... luteas glebas arefacientes struebant parietes (*paries*), vitandoque imbres (*imber*) et aestūs tegebant harundinibus et fronde.“

saepe etiam *fistula* pastoris harundo nominatur. harundine etiam *piscatores* pisces capiunt, ut videtur in imagine Pompeis inventā.

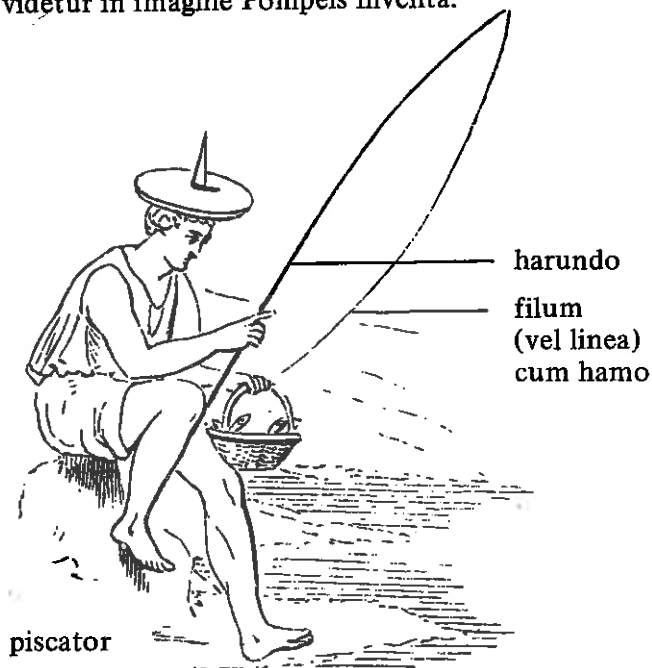

piscator

## haruspex –picis, m.

haruspex est qui exta victimarum inspicit atque ex iis futura praedicit. disciplina (= haruspīcina) erat Etrusca.

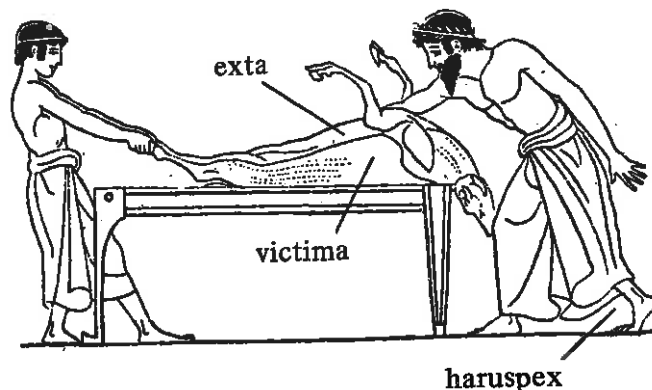





a Graeco hebdomos = septimus. hebdomas est spatium septem dierum deis Planetarum dicatum.

\*septimana = it. settimana, fr. semaine, hisp. semana.

series septem dierum hebdomadis haec est: Solis dies, Lunae dies, Martis dies, Mercurii dies, Iovis dies, Veneris dies, Saturni dies. (in imagine a dextrā ad sinistram)

### Hecate —es, f.

est Iovis et Latonae filia, soror Apollinis. est tricorpor et triceps, magicarum artium magistra ac fascinationum praeses, cincta latrantium canum turmā; noctu stans in triviis (*trivium*) vel prope sepulcra et ubi loca sunt caedibus contaminata.



Hecate triformis

### hedera —ae, f.

hedera est planta perpetuo virens, quae cum per se stare non possit, arboribus et parietibus adeo arcte adhaeret, ut rumpat et arbores necet.



hedera helix

### helcium —i, n.

est funis, quo equi vel homines currūs, navēs (*navis*) oneraque trahunt.

### cymba

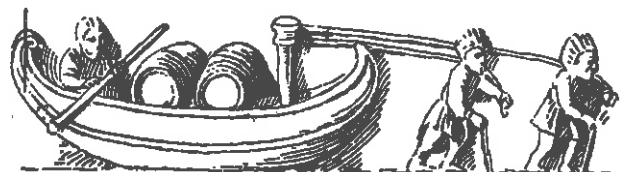

opus caelatum e Gallia Transalpina, duo helcarios monstrans

helciarius, -i, m., est is, qui funibus sive helciis (vide supra) cymbas adverso flumine trahit.

### heliotropium -ii, n.

heliotropium est herba solaris; solem intuetur semper cumque eo vertitur etiam nubilo die. (a Graeco „helios“ = sol, et „trepo“ = verto) = *Helianthus annuus* (Linnaeus).

Varro, r. r. 1, 46:

„nec minus admirandum quod fit in floribus, quos vocant heliotropia ab eo, quod ad solis ortum mane spectant et eius iter ita sequuntur ad occasum ut ad eum semper spectent.“



### Helvetia Romana

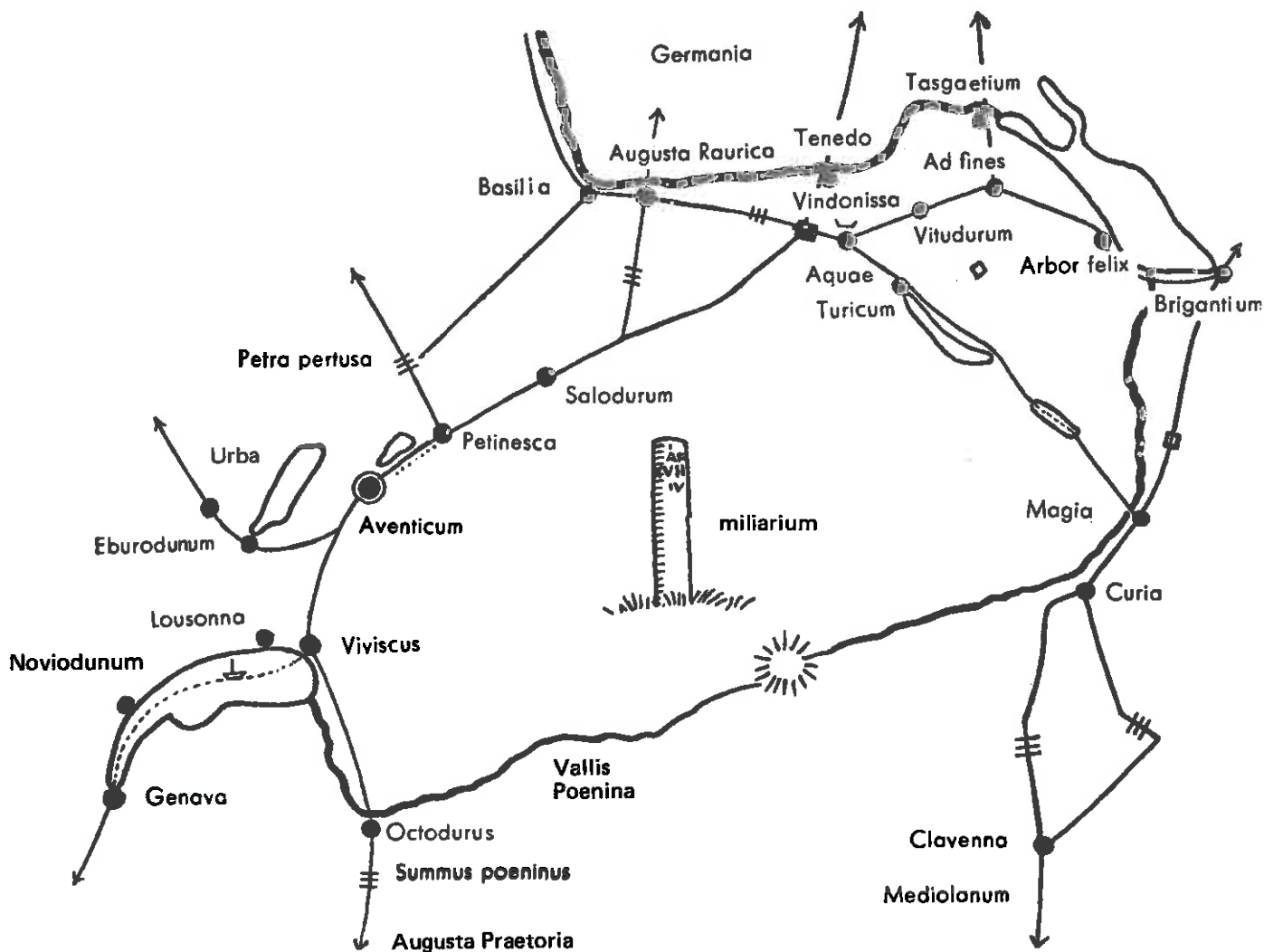

Hesperides —um, f. pl.



vas figuratum  
Rubi inventum,  
hortum Hesperidum repraesentans

filiae Hesperii; finguntur hortos (*hortus*) amoenissimos possedisse in extrema Africa, ubi erat auriferum nemus cum m̄lis aureis, quae a pervigili dracone (aut serpente) custodiebantur. Hercules tamen, eo penetrans Eurysthei iussu, draconem occidit et aurea m̄la ad eum attulit.

hippocampus —i, m.

est piscis marinus parvus, capite et iuba instar equi. item est marinum monstrum, equi simile, quo fabulantur ad currum iuncto vehi maris numina.

*Tritones Nereidesque* hippocampis per mare vehuntur deos marinos comitantes.

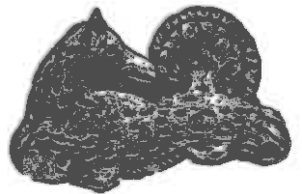

Hispania Romana



## Horae —arum, f. pl.

sunt deae, quae horis praesunt, Iovis ac Themidis filiae, apud mythologos communiter tres Horae sunt tribusque temporibus anni respondent.



tres Horae in opere caelato arae cuiusdam villae Borghese; exemplar huius operis caelati aetate Periclis (V. saeculo a. Ch. n.) perfectum est prima Hora, quae flores portat, respondet veri, secunda uvis autumnum indicat, tertia manu sinistra spicam frumenti gerens est aestas. deest quartum tempus anni, hiems.

## horologium —i, n.

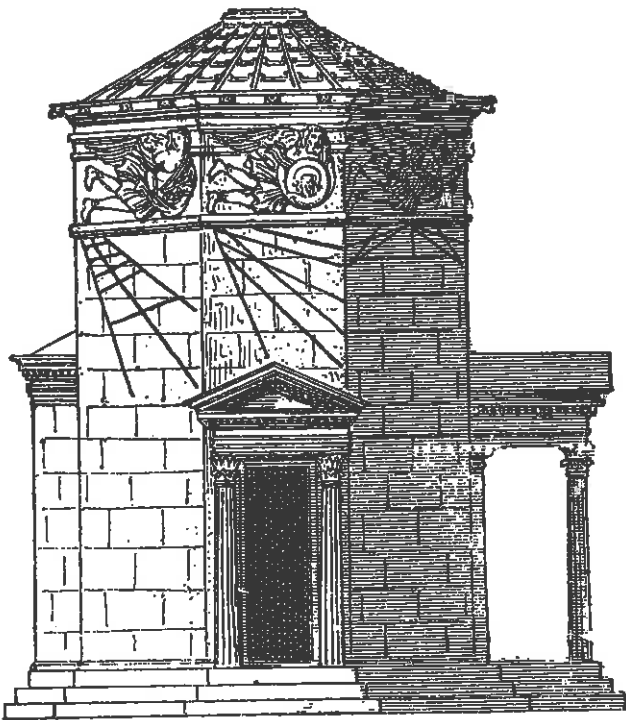

imago Turrif Ventorum, quae dicitur, Athenis etiam hodie servatam, monstrat, cuius latera solariis praedita sunt

horologium est instrumentum, quo tempus diei definitur, sive horologio solario sive clepsydra: in clepsydra aqua e superiore vase in inferius vas guttatim cadens tempus indicat.

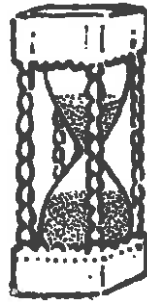

## horreum —i, n.

horreum est locus, in quo segetes post messem (messis) reponuntur.

Cicero, leg. agr. 2, 33, 89:

„illi Capuam ... cellam (cella) atque horreum Campani agri esse voluerunt.“

Ovidius, trist. 1, 9, 9:

„horrea formicae tendunt ad inania numquam.“

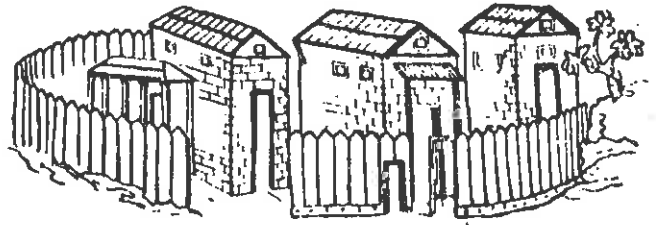

## hortator —oris, m.

est qui hortatur et suadet, ut aliquid fiat.

hortator remigum (vide imaginem) remigibus baculo numerum indicat.

Plautus, Merc. 695/96:

„quasi in mari solet hortator remiges hortarier.“

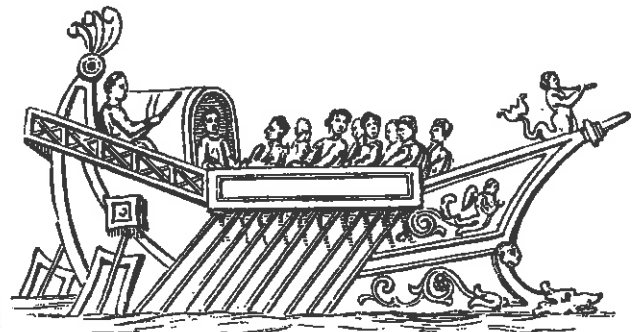

## hortus —i, m.

est locus maceriā aut saepe (*saepes*) clausus, in quo olera cibi causā coluntur; item in quo arbores, poma, flores voluptatis causa coluntur. maceria aut saepes hortum ab incursu hominum pecudumque munit. hortorum culturam monachi Christiani a Romanis acceptam nobis tradiderunt.



hortus Romanus maceriā saeptus, duobus fontibus cum siphunculis vel siphonibus (*sipho*) praeditus

## hostia —ae, f.

est vivum animal quod in sacris mactatur in honorem deorum. „purae hostiae“ dicuntur, quae ad sacrificium idoneae sunt.

Caesar, B. G. 8, 51:

„Exceptus est Caesaris adventus ab omnibus municipiis et coloniis incredibili honore atque amore ... hostiae omnibus locis immolabantur.“



hostia (ovis)

## hypocaustum —i, n.

est vaporarium, locus in thermis concameratus et fornicatus (*camera, fornix*), qui igne calefit. Vitruvius, 5, 10:

„est animadvertendum, uti caldaria muliebria viriliaque coniuncta et in iisdem regionibus sint collocata. sic enim efficietur, ut vasaria et hypocaustis communis sit eorum utrisque. aenea supra hypocaustum tria sunt componenda, unum caldarium, alterum tepidarium, tertium frigidarium.“



tria vasa aenea (aqua calida, tepida, frigida)

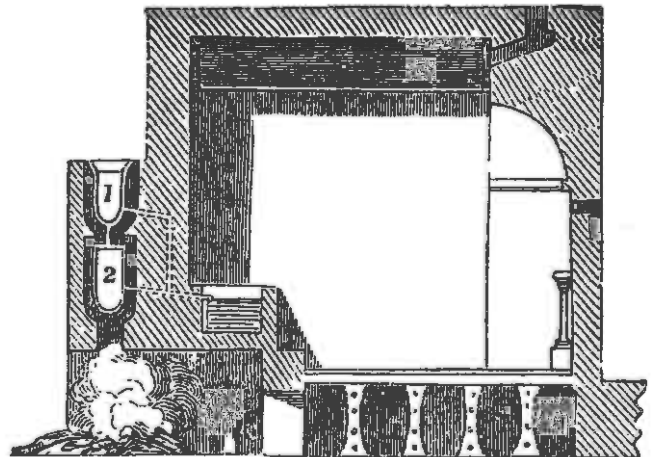

## ianus —i, m.

est totius mundi custos, caeli ianuis praesidet, omnium aedium foribus praeses est constitutus, item viis omnibus tam urbanis quam rusticis; ille caelum, aerem, terram, aquam, res omnes huius universitatis claudit et aperit, pacem et bellum in sua potestate habet.

Ianus biceps aut bifrons nominatur, i. e. duo capita aut duas frontes habet, quod tempus praeteritum et tempus futurum simul spectat, tamquam in limine temporum stans, ut in hoc nummo Romano delineatus est.

a Iano primus mensis anni mensis Ianuarius dicitur. de Iano Ovidius (Fast. I, 117/18) haec dicit:

„quidquid ubique vides, caelum, mare, nubila,  
terras,

omnia sunt nostrā clausa patentque manu.“  
Iani templum in Foro Romano in bello apertum, in pace clausum erat.



## iecur —coris, n.

est viscus maximum in dextrā parte corporis sub praecordiis situm, cuius inspiciendi plurimus fuit in haruspicinā (haruspex) usus.

Cicero, nat. deor. 1, 35, 99:

„cerebrum, cor, pulmones, iecur, haec enim sunt domicilia vitae.“

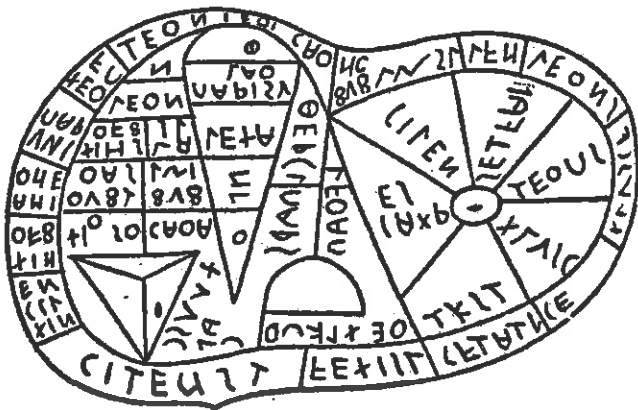

delineatio iecoris Etrusci

## imago —inis, f.

a) est simulacrum, species, exemplar, alicuius rei repraesentatio.

b) item de imagine hominis aut rei, quae a phantasia excitatur, cuiusmodi sunt quae in somniis apparent, mortuorum umbrae, etc.  
ius imaginum: apud Romanos qui maiorum suorum habuerunt imagines, ii erant nobiles; qui suas tantum, ii novi; qui nec maiorum, nec suas, illi demum ignobiles appellati sunt. imaginem porro sui ponere non temere omnibus licuit, sed iis tantum, qui magistratus curules gessissent. has imagines primi patricii posuerunt, quod iis primis curules magistratus patuerunt, unde ius imaginis fuit.



huiusmodi imaginibus ornabant atria aedium easque in funebribus pompis proferebant circumferebantque. (funus)  
imaginarius, vel imaginifer  
est qui imaginem imperatoris fert.



imaginarius

verbum imaginar: imaginari est rei alicuius, quae facta sit vel fieri possit, vel etiam quae fieri non possit, similitudinem mente concipere.  
Quintilianus, 9, 2, 41:

„nec solum quae facta sint aut fiant, sed etiam quae futura sint aut futura fuerint, imaginamur.“

## impedimenta –orum, n. pl.

impedimentum est id, quo quis impeditur, quo minus perficiat quod cupit, impeditio, mora, obstaculum. saepissime de sarcinis exercitūs, qua significatione pluralis numerus usurpatur, et impedimentorum nomine veniunt etiam calones et iumenta.

Caesar, B. G. 1, 26:

„alteri se in montem receperunt, alteri ad impedimenta et carros suos se contulerunt.“  
imago e columna Traiana, impedimenta cum carris et iumentis (equis et bubus) sarcinis onustis.

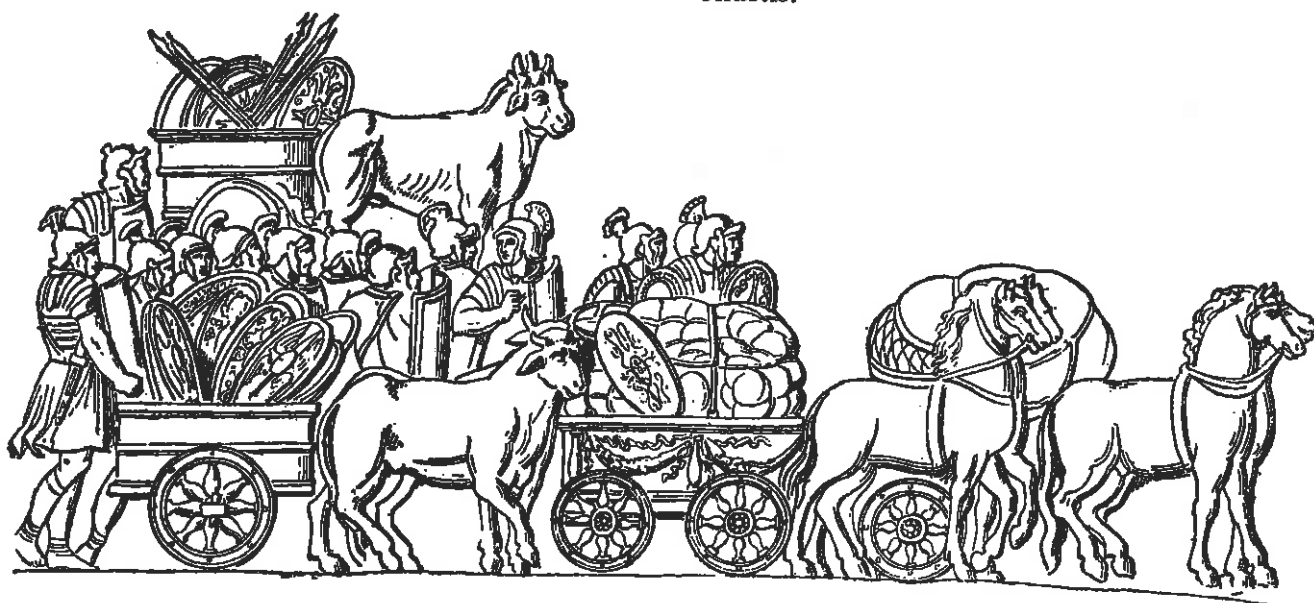

## incunabula –orum, n. pl.

a) ea, quae cunis insunt, quae ad cunas muniendas et ornandas pertinent, id est lectulus et fasciae lineae lanaeque, quibus infantes involvuntur.

b) sumitur pro loco, ubi nati sumus.

c) etiam pro „principio“ et „origine“ sumitur.

Cicero, de orat. 1, 6, 23:

„ab incunabulis nostrae veteris doctrinae ...“

\*\*incunabula nominantur prima opera arte impressoriā in lucem edita (inter annos circiter 1450–1500).

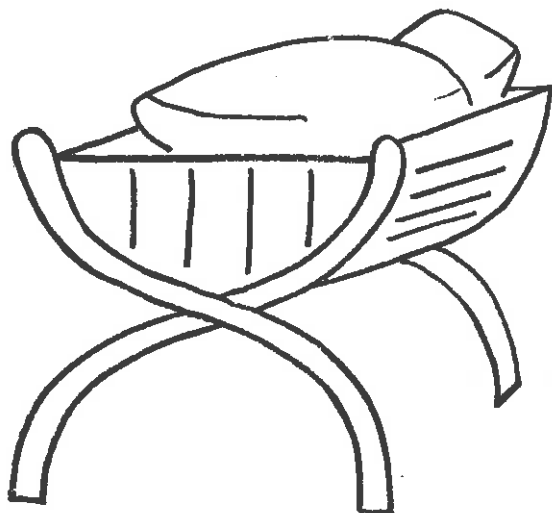

cuna

## incus –udis, f.

incus est instrumentum ex solido ferro, super quod fabri ferri massas cudunt et formant.

Cicero, Nat. D. 1, 20, 54:

„formae ... quas vos effici posse sine follibus (follis) et incudibus non putatis.“

proverbium: „incudem eandem tundere“ = in eodem labore perseverare.

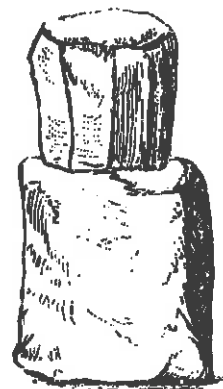
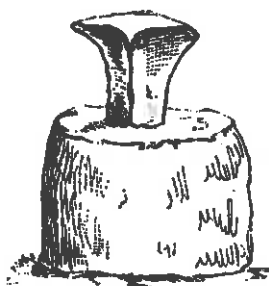

## index –icis, m.

qui aliquid indicat, defert. digitus index est digitus, quo res indicamus.  
in libris index est summa, seu elenchus, quo res, quae in iis continentur, summatim indicantur. \*\*\*in tabernis index ciborum cibos indicat, qui hodie offeruntur.

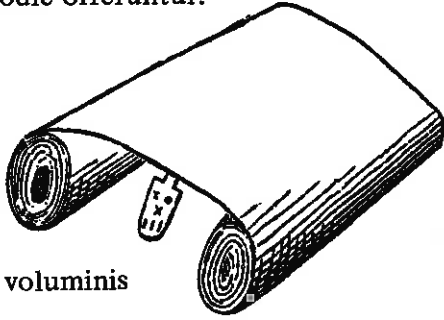

index voluminis

## infula –ae, f.



vitta

infula  
sacerdotis

infula generatim est quaelibet fascia. speciatim ac saepius est ornamentum capitis sacerdotale. Paulus Diaconus, p. 113, 1:  
„infulae sunt filamenta lanae, quibus sacerdotes et hostiae templaque velabantur.“  
Servius, ad Aen. 10, 538:  
„infula est fascia in modum diadematis, a qua vittae ab utraque parte dependent, quae plerumque tortilis, de albo et cocco.“

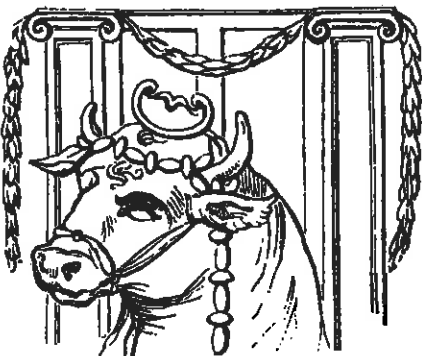

hostiae  
infula

## infundibulum –i, n.

a) est vas in summo latum et expansum, in imo angustum et in fistulam desinens, quo in vasa angusti oris liquores infundimus.  
b) speciatim est instrumentum, per quod frumentum in molam (mola) infunditur.



## \*\*initialis (sc. littera)

est prima littera manuscripti, paginae aut capituli, quae minio (minium) delineatur et picturis ornatur.



## insigne –is, n.

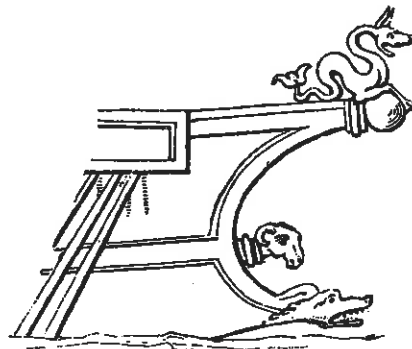

insigne  
navis



insignis est qui signo (*signum*) aliquo vel *notā* inter alia eminet.

insigne, -is, n., est tabula vel imago vel *signum*, quo res notantur, exempli gratia *naves*, *tabernae* aliaque. etiam magistratūs insignibus quibusdam praediti erant, ut consules aut praetores lictoribus (*lictor*).



insigne tabernae Pompeianae

### instrumenta musica

instrumenta musica sunt triplicis generis:

a) alia, quae *spiritu* inflantur ut *tibiae*, *fistulae*, *tubae*, *cornua*, *organa* (hydraulica).

b) alia, quae *nervis* intenduntur ut *lyra*, *cithara* et alia.

c) alia, quae *manu* pulsantur ut *tympana*, *sistra*, *cymbala* etc.

tuba

organum hydraulicum

cornu

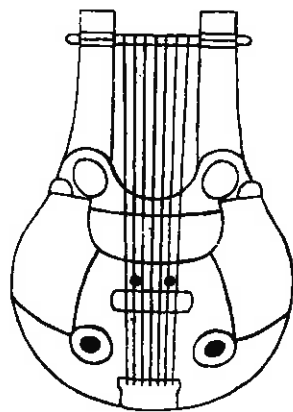

cithara, -ae, f.

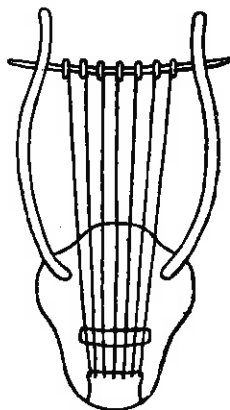

lyra, -ae, f.

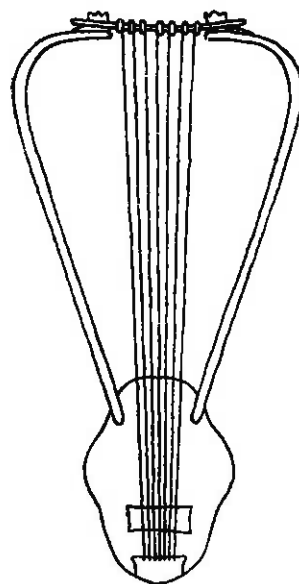

barbitum, -i, n.

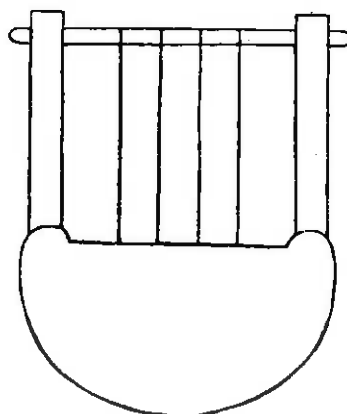

phorminx, -ingis, f.

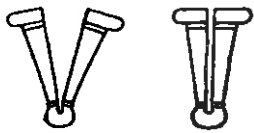

crotala, -orum, n.

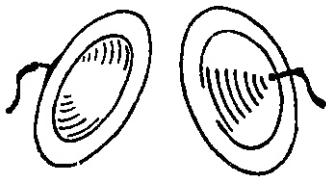

cymbala, -orum, n.

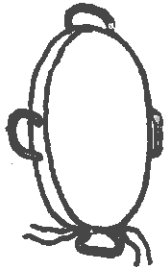

tympanum, -i, n.

## instrumenta scribendi

stilus      tabula      volumen epistulae  
sigillo signatum et  
inscriptione praeditum

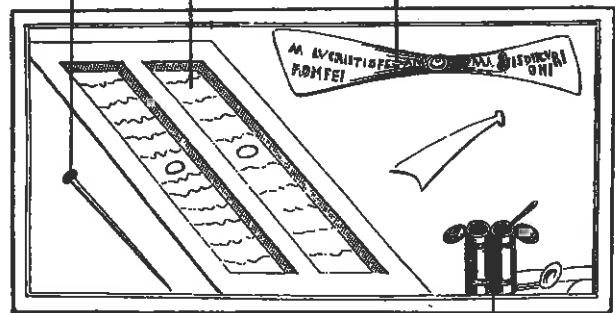

atramentarium cum calamo et atramento.  
imago in domo Lucretii, Pompeiis inventa

## insula -ae, f.

- a) est terra in medio mari, undique aquis cincta.  
b) latiore sensu est terra seu locus flumine aut lacu clausus.  
c) a similitudine insulae dicuntur domus urbanae, quae non iunguntur communibus parietibus cum vicinis, circuituque publico aut privato cinguntur. insulae plura cenacula et cubicula habebant, quae pluribus familiis locabantur et fere pauperiorum.

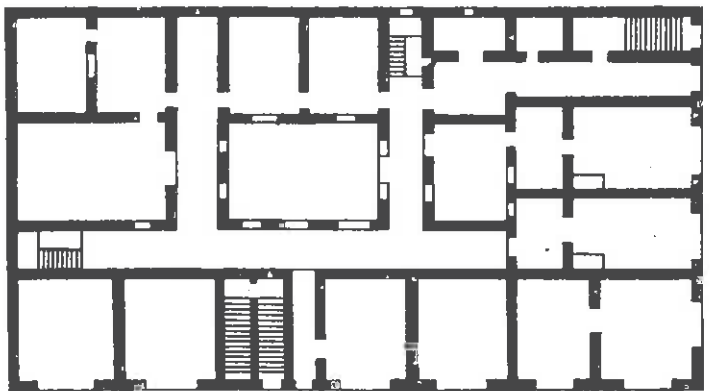
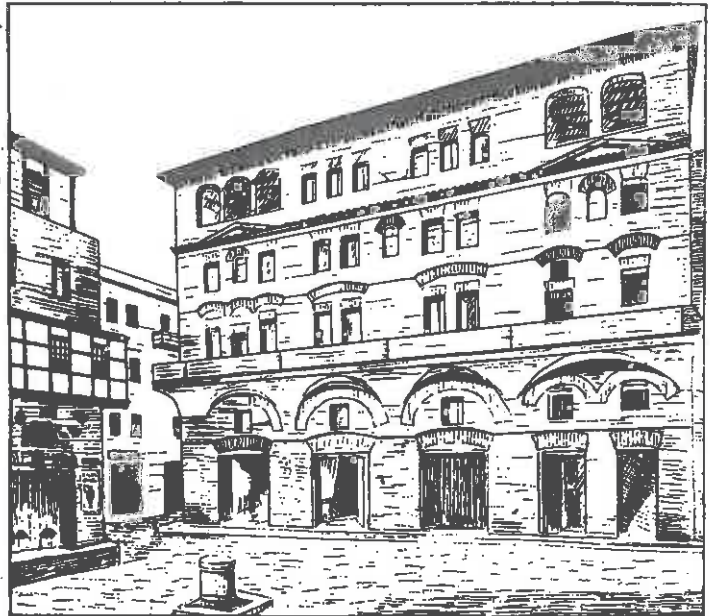

insula „Dianae“ quae dicitur, Ostiae sita, orthographia et ichnographia

intervallum —i, n.

a) dicitur de quovis loci spatio vacuo et distantia. Cicero, ad fam. 1, 7, 1: „quoniam intervallo locorum et temporum disjuncti sumus ...“

b) in re musica distantia duorum sonorum intervallum dicitur.

Cicero, Tusc. 1, 18, 41:

„harmoniam autem ex intervallis sonorum nosse possumus, quorum varia compositio etiam harmonias efficit plures“ (*canon*)

absolute intervalla hoc modo nominantur: prima, secunda, tertia, quarta, quinta, sexta,

septima, octava, nona, decima (sc. nota). Guido Aretinus, qui primus artem musicae notandae invenit, relative intervalla secundum primas syllabas hymni in Sanctum Iohannem denominavit: „ut queant laxis / resonare fibris / mira gestorum / famuli tuorum / solve pollutis / labii reatum ...“

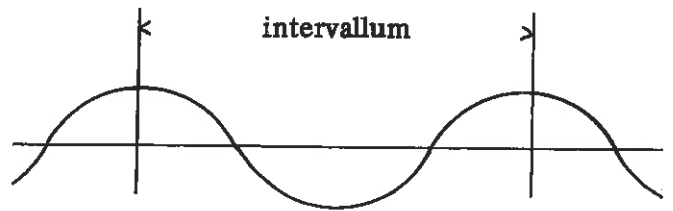

Italia



## iugum -i, n.

est ligneum instrumentum recurvum, quod duorum boum (aut equorum) collo transversum impositum, eos simul iungit et colligat. in quadrigis (*quadriga*), ubi equi quaterni aequa fronte iuncti erant, duo medii iugum

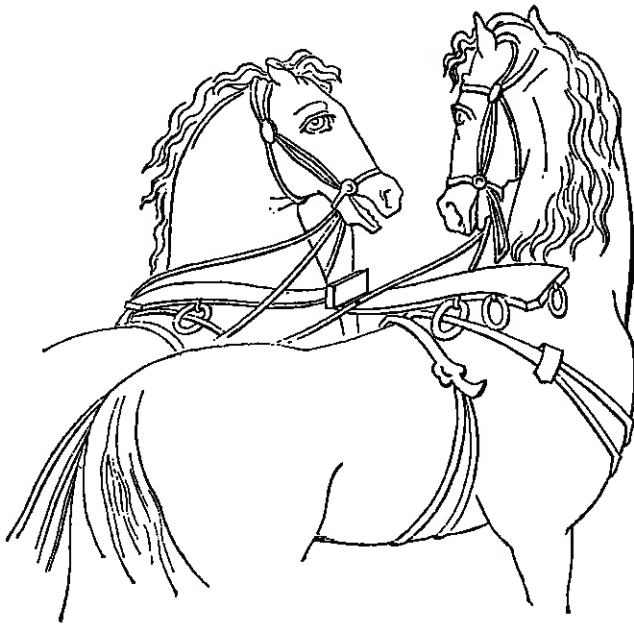

equi iugales

habebant, duo reliqui funibus (*funis*) ac loris alligabantur. hinc illi *iugales*, hi *funales* dicti. saepe hostes victi a Romanis sub iugum missi sunt; quod erant *hastae* in modum iugi iunctae.

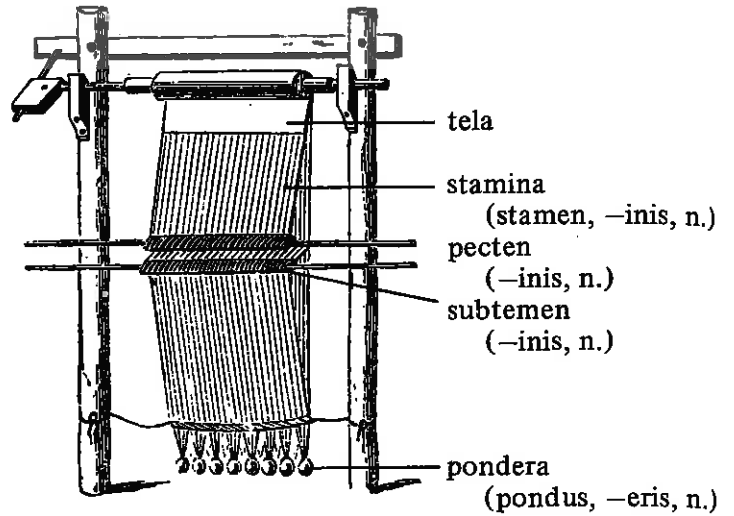

iugum textorium

## labarum —i, n.

est *vexillum* militare auro intextum, gemmisque (*gemma*) intermicantibus splendidissimum, quod imperatori praeferri atque a militibus paene adorari solebat.

Constantinus imperator labaro coronam (*corona*) imposuit cum cruce et litteris initialibus (*initiale*) nominis Christi X P hoc modo:

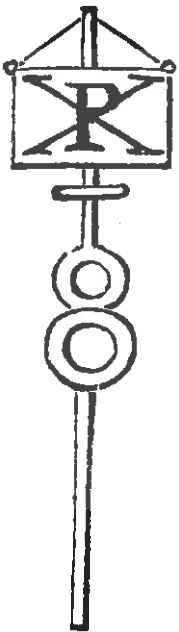

## labrum —i, n.

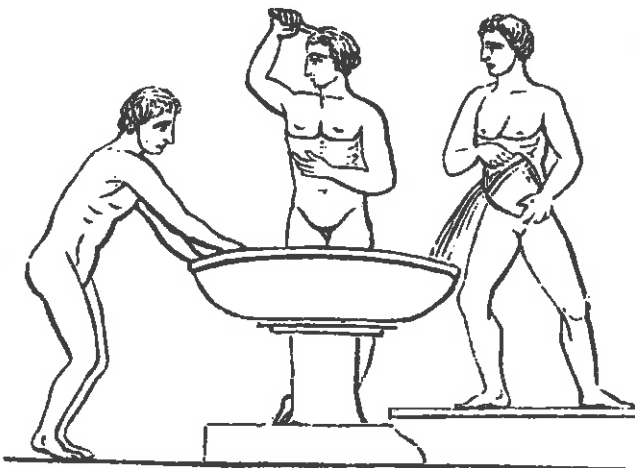

est vas grande latique oris, diductas habens oras et in exteriorem partem, in modum labrorum repandas, unde se balneatores aquā frigidā

aspergebant, ut in imagine monstratur: aquarius aquam labro infundit, balneator se strigil radit. (*strigilis*)

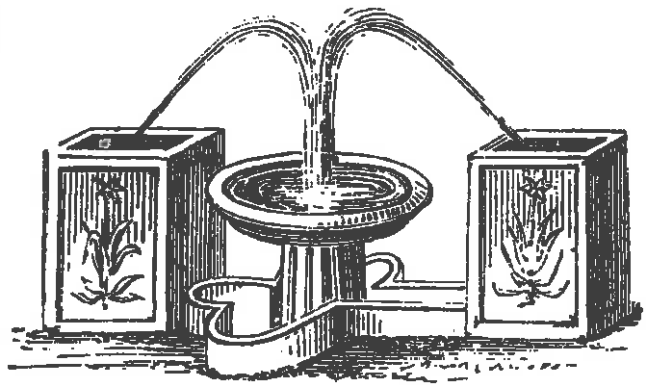

labrum siphone (sipho) munitum

## labyrinthus —i, m.

est locus multis viarum ambagibus inflexus, ex parietibus vel ex arboribus. omnium celeberrimus erat labyrinthus Creticus, perplexis parietibus (*paries*), factus a Daedalo (*Daedalus*) iussu regis Minois, in quo Minotaurus monstrum biforme inclusum erat. iterum ambagibus, occursibus et recursibus difficillimus labyrinthus omnium erat.

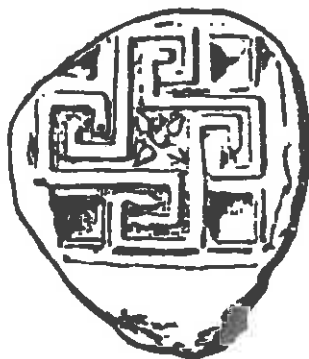

nummus (drachme) Creticus, in fronte Minotaurum, a tergo labyrinthum monstrans

## lacerta —ae, f.

est serpens quadrupes satis nota; e genere reptilium: lacerta agilis, lacerta vivipara. in terris Mari Mediterraneo adiacentibus genus lacertae est, quod Tarentola Mauretunica vocatur. haec lacerta pedibus suis parietibus tectisque adhaerere potest.

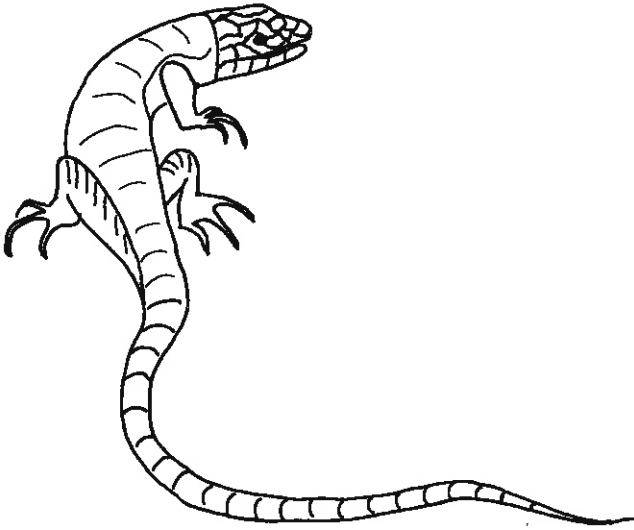

## lana —ae, f.

lana sunt pili ovium, lanarii sunt artifices lanae faciendae.

Ovidius, met. 4, 34:

„aut ducunt lanas, aut stamina pollice versant.“  
in imagine lanarii magnam molem lanae restibus (restis) constringunt ut facilius asportetur. in sinistra parte scriba rationes mercium expeditarum in tabellā perscribit.

proverbium: „rixari de lanā caprinā“

Horatius, ep. 1, 18, 15:

„alter rixatur de lanā saepe caprinā  
propugnat nugis armatus ...“

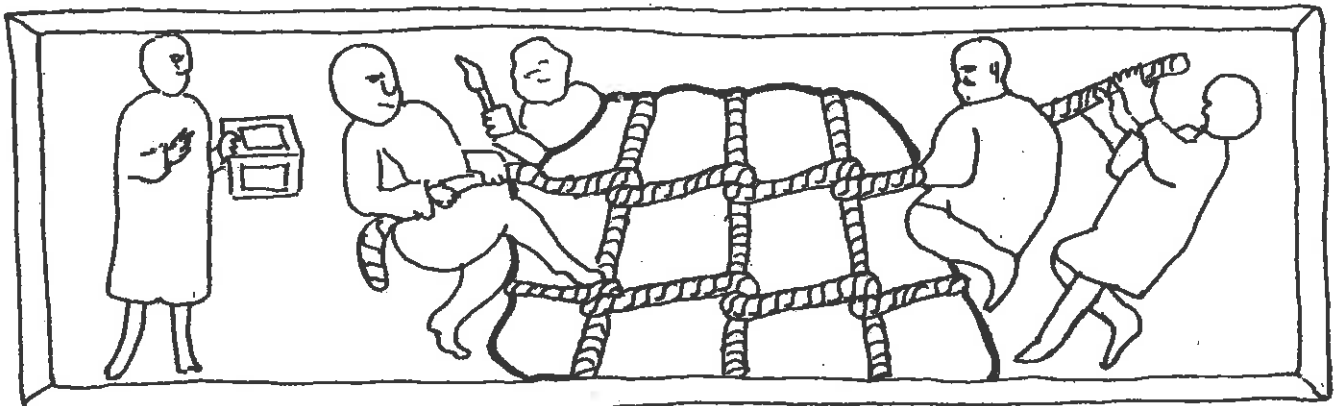

de re inutili minimique momenti decertare, nam capris non est lana, sed setas gerunt. lana, quae cottidie ancillis appenditur, earum pensum est, quod absolvant.

## lanx —cis, f.

a) lanx est vas escarium latum et cavum ex aliquo nobiliore metallo plerumque factum, in quo cibi reponuntur et mensae inferuntur.

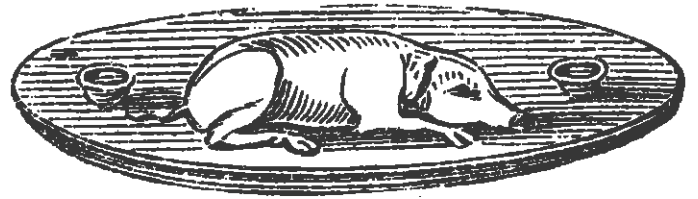

b) a similitudine lances sunt in libra duo illa vascula, in quorum altero pondus, in altero res ponderanda imponitur; unde bilanx dicta.

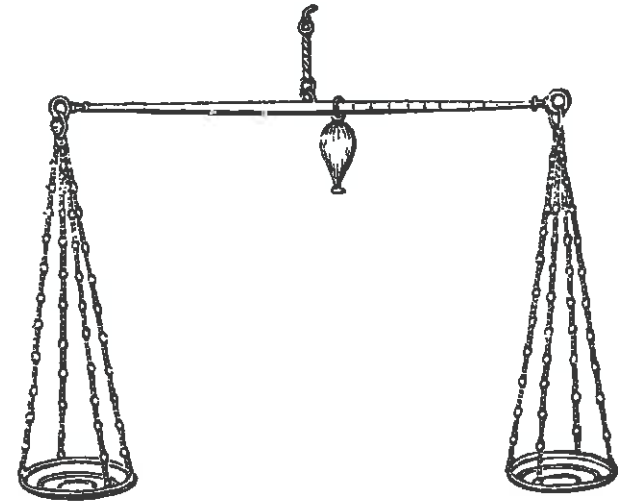

libra bilanx

## Laocoon —ontis, m.

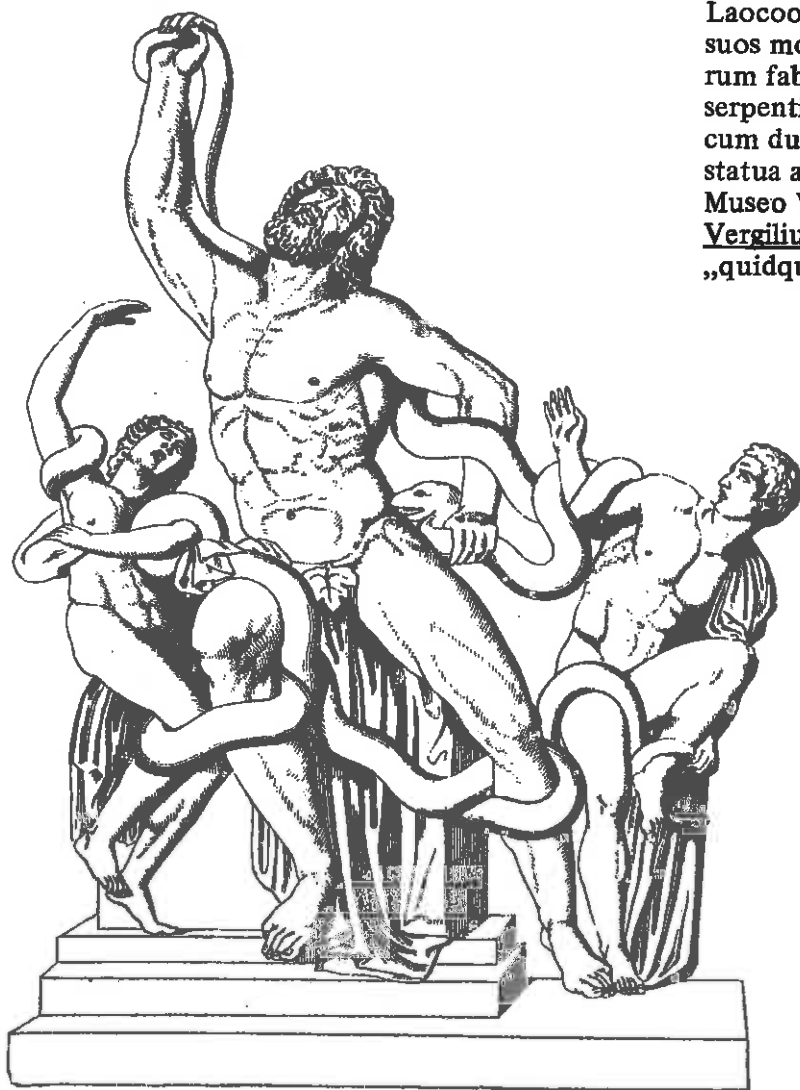

Laocöon sacerdos erat Troianorum qui cives suos monuit, ne equum ligneum dolo Graecorum fabricatum in urbem introducerent. a serpentibus a Minervā missis coram civibus unā cum duobus filiis oppressus et peremptus est. statua aetatis hellenisticae quae dicitur in Museo Vaticano servatur.  
Vergilius, Aen. 2, 49 eius verba ita tradit:  
„quidquid id est, timeo Danaos, et dona ferentes.“

## lapidarius —i, m.

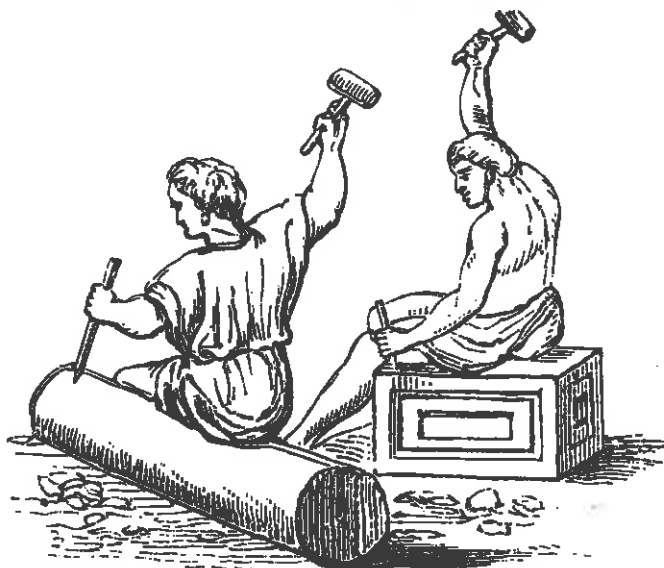

a) ad lapides pertinens.  
b) (faber) lapidarius, qui lapides findit aut sculpsit (*artificia*). in lapicidina vel latomia lapidarius officium suum exercet.

## laquear —aris, n. (aut lacūnar, —aris n.)

est interstitium tignorum in caelo conclavis, ex eo dictum, quia inter tignum et tignum veluti lacuna est: item ipsum caelum seu tabulatum, sive *contignatione* constet, sive tabulis suffixis, et inter plana intervalla cavitates sive lacūs habentibus, sive etiam aequato opere coagmentatis. Hae laquearia picturis aliisque ornamentis ornari solebant.

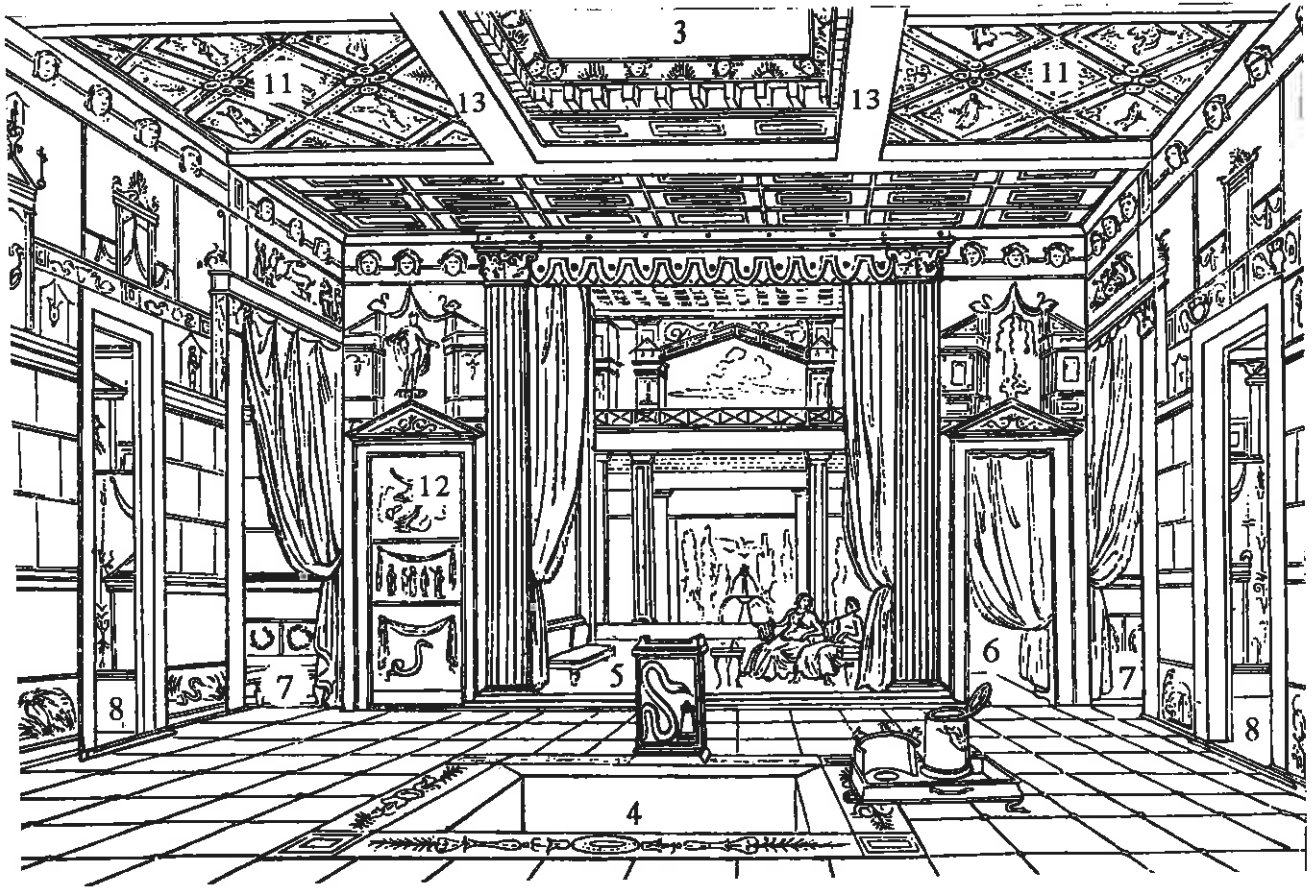

domus Pompeiana (reconstructa)

- 1 vestibulum
- 2 atrium
- 3 compluvium
- 4 impluvium
- 5 tablinum
- 6 triclinium
- 7 alae
- 8 cubicula
- 9 tabernae
- 10 hortus
- 11 laquearia in tecto aut caelo conclavium
- 12 aedicula
- 13 tignum

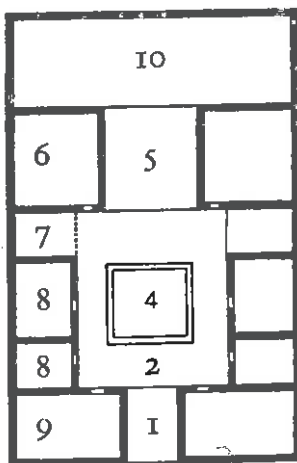

ichnographia  
eiusdem  
domūs

laqueus -i, m.

a) laqueus est vinculum ita nexum, ut pondere magis claudatur.

Cicero, Verr. 4, 17, 37:

„homini iam collum in laqueum inserenti subvenisti.“

b) laqueus est fraus, insidiae:

Ovidius, Ars. Am. 3, 591:

„dum cadit in laqueos captus ... amator“

Quintilianus, 5, 10, 101:

„in laqueos inexplicabiles incidere.“

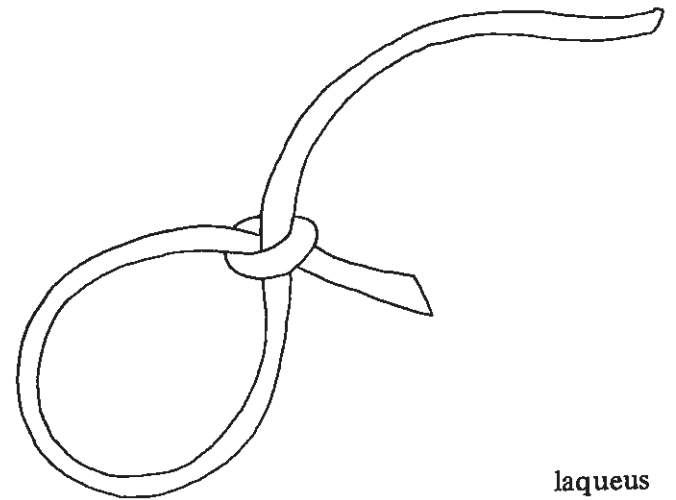

laqueus



**laridum** -i, n. (vel lardum -i, n.)

est caro suilla cum suo pingui sale condita et siccata.

Plautus, Capt. 903:

„quanta pernis (perna) pestis veniet!  
quanta labes larido!“

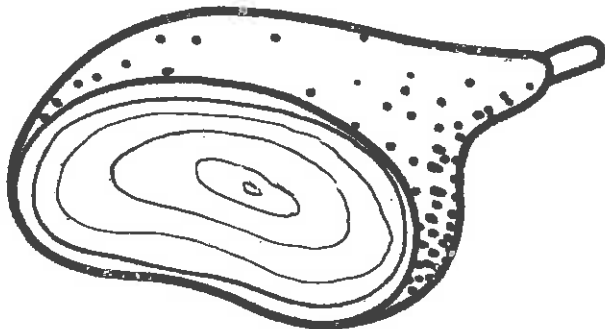

**later** -eris, m.

later est terra in variam formam durata, sive igni percocta sit, sive non, in usum aedificandi; deminutivus: laterculus (eadem significatione).

Varro, R. R. 1, 14, 4:

„saepimentum ... quod e lateribus coctilibus, ut in agro Gallico, quod e lateribus crudis, ut in agro Sabino.“

modus dicendi: lateres coquere.

proverbium: „laterem lavare“ = rem inutilem facere.

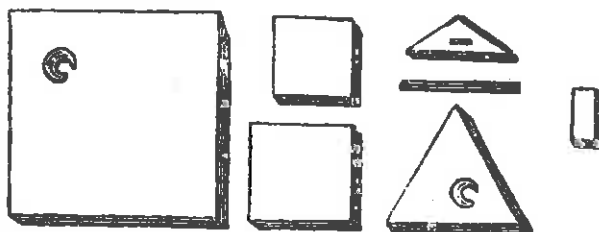

**laterna** -ae, f.

est instrumentum ex laminis corneis, vel ex alia materia, in quo candela accensa, vel ignis oleo ardens includitur, ne a vento extinguatur. nocte

lateris via illustrabatur, ut apud Plautum, Amphitr. 148:

„Servus Sosia a portu illic nunc cum laterna advenit.“

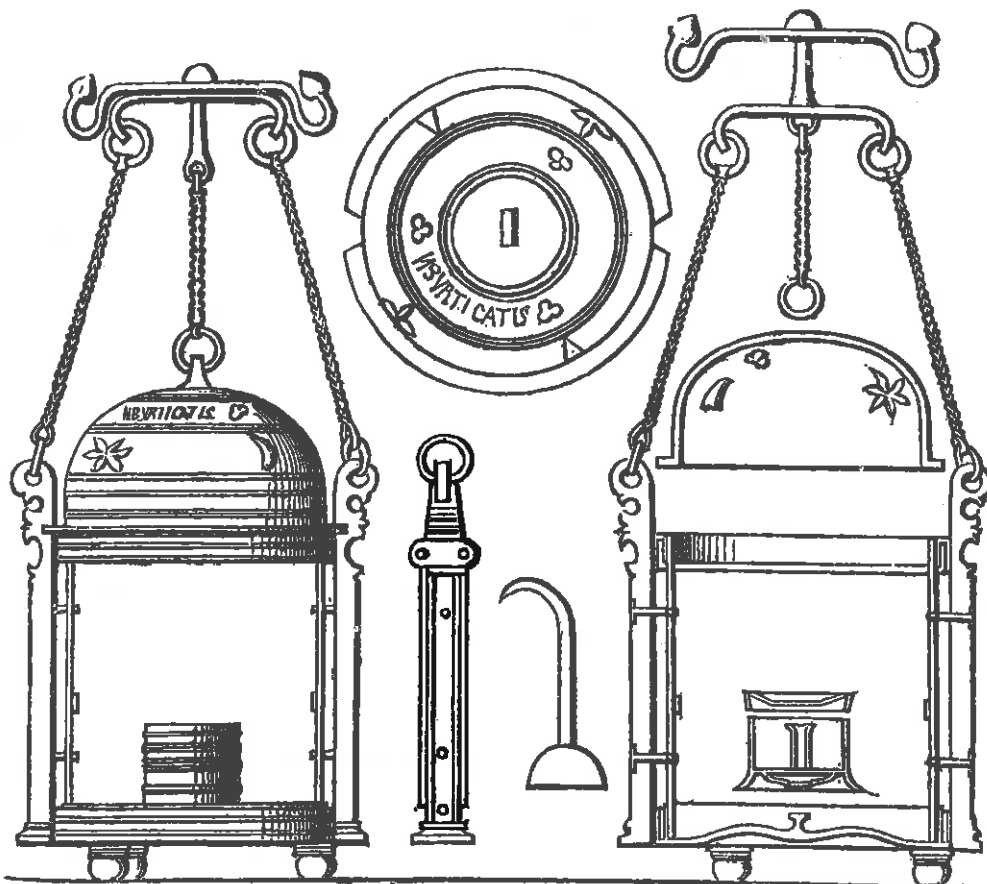

laternae Pompeianae

## latifundium –i, n.

latus fundus, ampla possessio agri.  
Plinius, H. N. 18, 35:

„verum confitentibus, latifundia perdidere  
Italiam, iam vero et provincias.“

## Latium –i, n.

est regio Italiae mediae, limites habens inter  
Etruriam, Umbriam, Samnium et Campaniam  
et mare inferum, cuius pars septentrionalis a  
Latinis colebatur. urbes et oppida: Roma caput  
orbis, Ostia, Tibur, Praeneste, Tusculum, Antium,  
Tarracina, Fregellae, Minturnae.

viae: Via Cassia, Via Aurelia, Via Portuensis,  
Via Appia, Via Latina, Via Valeria, Via Salaria,  
Via Flaminia.

montes: mons Albanus  
flumina: Tiberis, Anio, Liris.

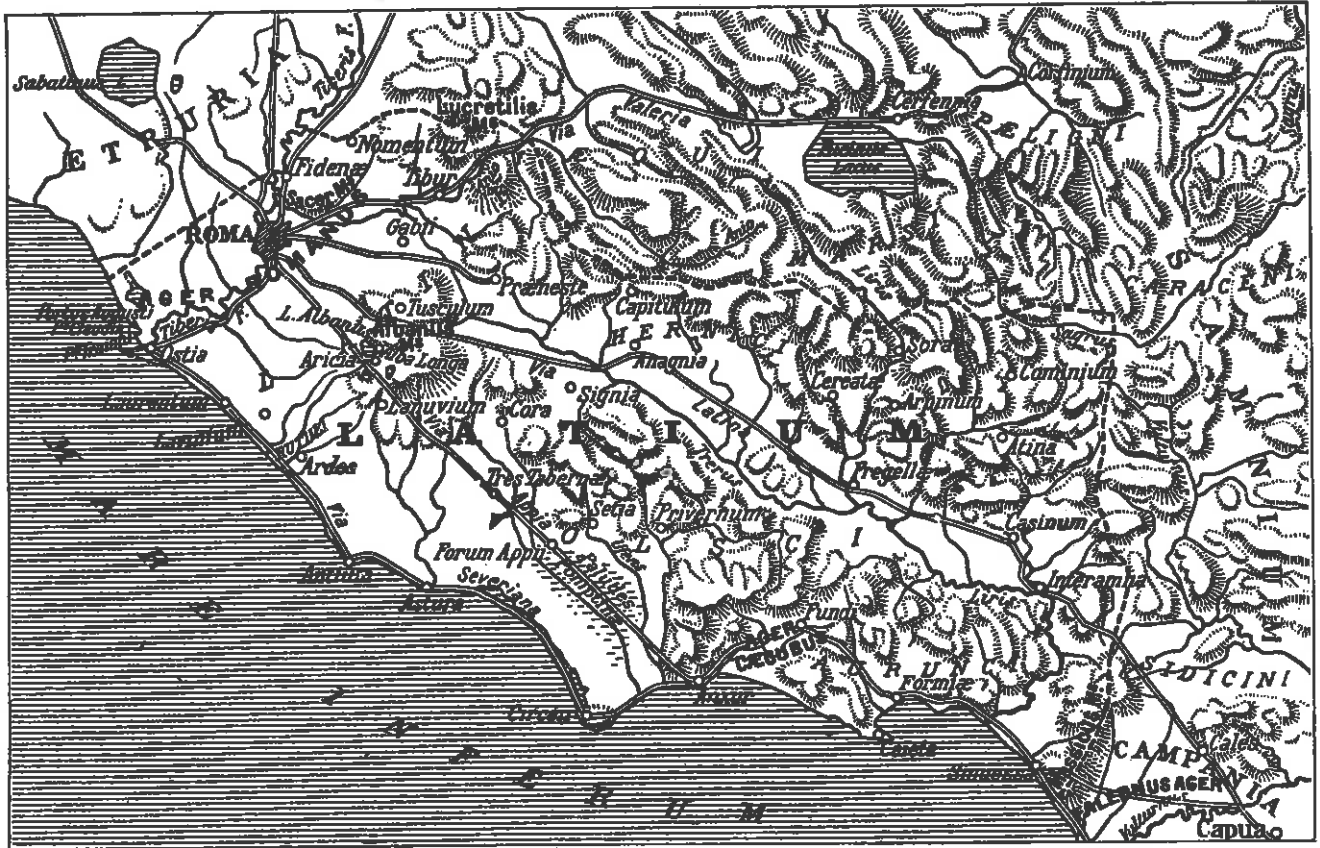

## lectica –ae, f.

est sella cum pulvino et lectulo, quā divitiores  
cubantes servorum humeris vel duorum, ut  
tenuiores, vel quattuor aut sex aut octo, ut di-  
tiores, ferebantur, primum quidem itineris causā  
extra urbem, deinde paulatim etiam in ipsā urbe,  
deliciarum causā.

lecticarius servus est qui lecticam defert.

pulvinus

lectulus

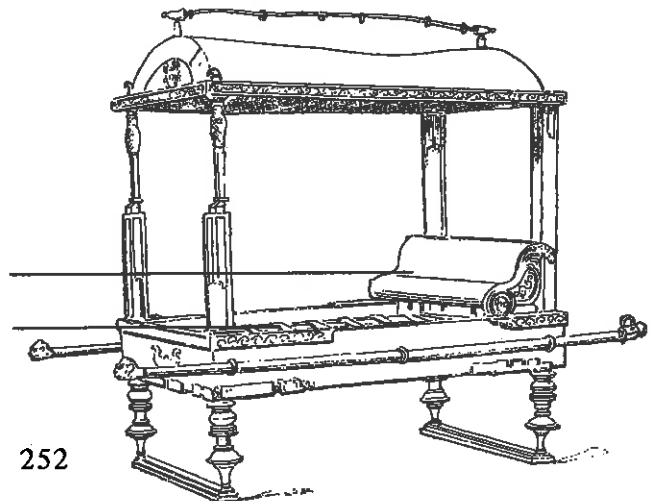

## lectisternium —i, n.

est *sacrificii* genus, in quo deis in templis pulvinaria sive lecti sternebantur, *conviviumque* iis apponebatur.

appositis epulis septem sacerdotes, qui dicti sunt *Epulones*, fruebantur.

*Livius*, 5, 13, 6:

„duumviri sacris faciundis, lectisternio tunc primum facto, per dies octo Apollinem Latonamque et Dianam, Herculem, Mercurium atque Neptunum, tribus quam amplissime tum apparari poterat, stratis lectis placaverunt.“

*idem* 22, 10, 9:

„curatum lectisternium, et per triduum habitum, decemviris sacrorum curantibus: sex *pulvinaria* in conspectu fuere, Iovi et Iunoni unum, alterum Neptuno ac Minervae, tertium Marti et Veneri, quartum Apollini ac Dianae, quintum Vulcano ac Vestae, sextum Mercurio ac Cereri.“



lectisternium in *lucerna* fictili opere caelato sculptum; dei sunt Serapis, Isis, Luna et Sol

## lectus —i, m.

et deminutivus lectulus, parvus lectus, est *cubile* stratum iacendi et dormiendi causā.

in lecto triclinari Romani mensae accumbebant. (*triclinium*)

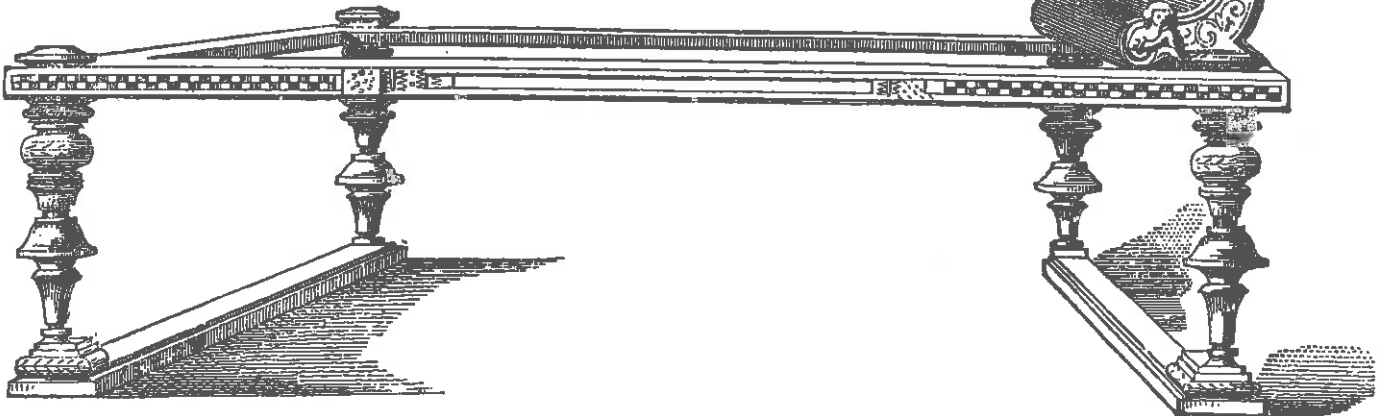

lectus aeneus, argento indutus

## legenda —orum, n. pl.

legendarius liber „acta Sanctorum per anni totius circulum digesta continens, sic dictus, quia certis diebus ‚legenda‘ erant in Ecclesia.“ (Du Cange)

„*Legenda Aurea*“ titulus operis Iacobi a Voragine, saeculi XIII. p. Ch. n. notissimum opus huius generis est.

lepus —ōris, m.

lepus est animal timidissimum et fecundissimum, aures longas habens; itaque Vergilius lepores aurītos nominat. (Georg. 1, 308). leporarium est locus, ubi lepores aluntur, sed etiam omnia saepta, quibus animalia includuntur, sic appellantur.

Varro, r. r. 3, 3, 2: „leporaria te accipere volo non ea, quae tritavi nostri dicebant, ubi soli lepores sint, sed omnia saepta, affixa villae quae sunt; et inclusa habent animalia, quae pascantur.“ cuniculi genus silvaticum leporum sunt, ex Hispaniā oriundum. (*cuniculus*) proverbium: duos qui lepores insectatur, neutrum capit.



leporarium

vir leporem in leporario panno captat.

opus caelatum Orolauni (Arlon, Belgica) inventum

libella —ae, f.

est instrumentum fabrile, quo utuntur ad examinandas planae superficiei inclinationes, quemadmodum *normā* angulos metiuntur, perpendicularo (*perpendicularum*) erecti operis directam aut obliquam positionem. constat autem libella duabus regulis ita iunctis ex altera parte, ut angulum efficiant, in ima vero parte alia recta pro basi: in summo angulo filum habet plumbo pendente, ex quo inclinatio omnis deprehenditur. estque figura litterae A in imo clausae.

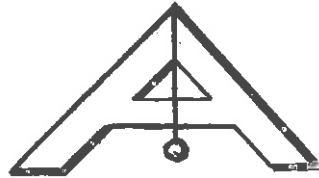

Plinius, H. N. 7, 198:

„Daedalus *serram, asciam, perpendicularum* invenit, *normam* autem et *libellam* et *tornum* Theodorus Samius.“

Varro, r. r. 1, 6, 6:

„campester locus is melior, qui totus aequabiliter in unam partem verget, quam is, qui est ad libellam aequus.“

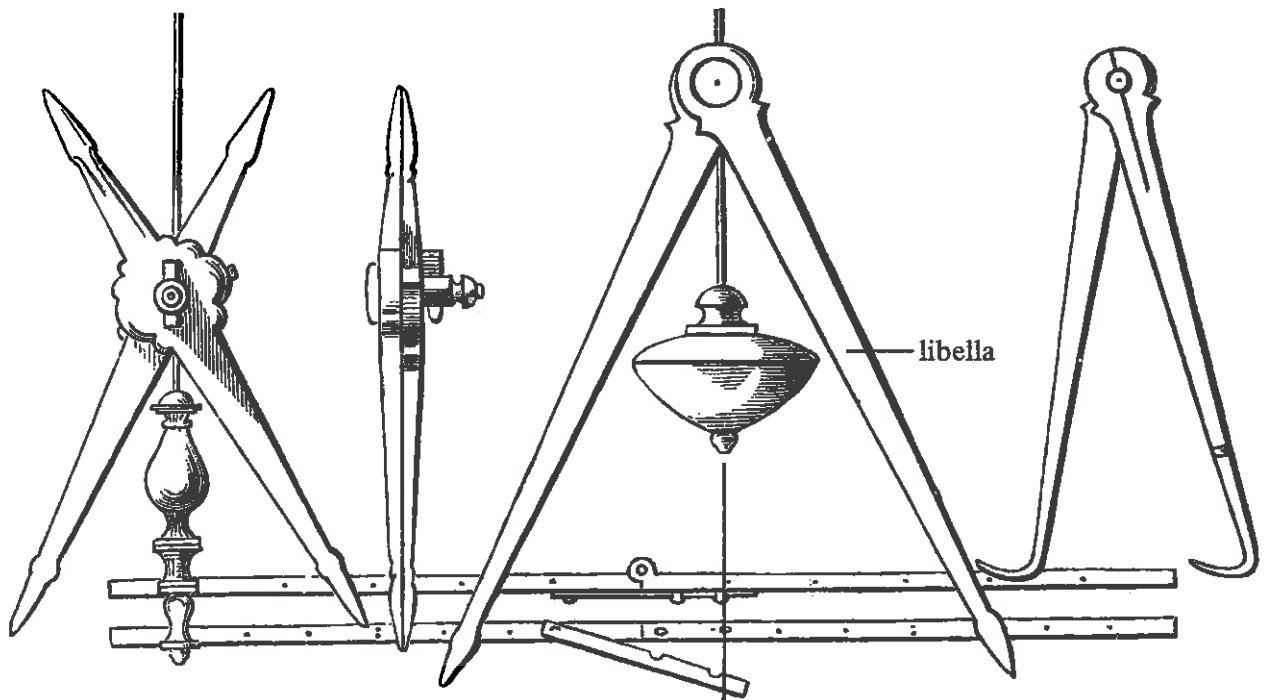

perpendicularum



novem volumina in armario deposita

atramentarium atramenti plenum

evolvere volumen aut librum = legere librum

liber est

a) interior pars corticis arbusculae, quae *papyrus* vocatur. e libro facta sunt folia, quibus facile inscribi poterat.

b) folium perlongum e libro factum

c) volumen huius folii = liber

antiquis temporibus folia perlonga manu scripta formā voluminum in capsis aut armariis conservabantur. ut legi possent, volumina duabus manibus evolvebantur ut imago in sarcophago quodam exsculpta demonstrat.

in pluteis armarii varii codices sunt. vir in scamno sedens pennā atramento tinctā scribit. ante armarium utensilia scribendi delineandi-que sunt: stilus, circinus, atramentarium aliaque. codex (caudex) ▷

a) truncus arboris est aut massa ligni. (*codicillus*)

b) summa tabellarum cerā illitarum formam codicis praebebat et codex nominabatur.

c) folia chartarum eodem modo colligata codex nominabantur, liber crassus et magni ponderis. multi librarii in eodem conclavi sedentes textum a lectore recitatum propria manu scribebant. sic orationes Ciceronis et alia opera in scriptorio Attici, amici eius, multiplicati et postea magno pretio divulgati sunt. etiam in monasteriis prioris Medii Aevi textūs describebantur et sic in posterum conservati sunt.



ultimis temporibus Imperii Romani, aetate iam Christiana, textūs foliis in forma codicum colligatis manu inscribebantur, ut in scriptorio hoc patris cuiusdam ecclesiastici videmus.

## libra –ae, f.

instrumentum est quo ad pendenda pondera utimur.

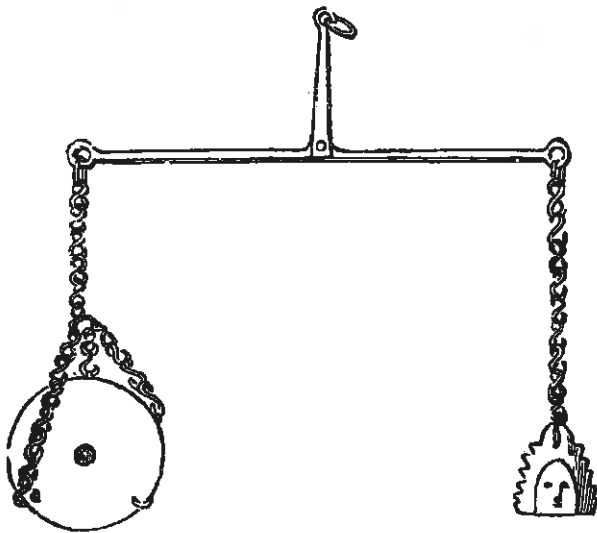

libra sine balance

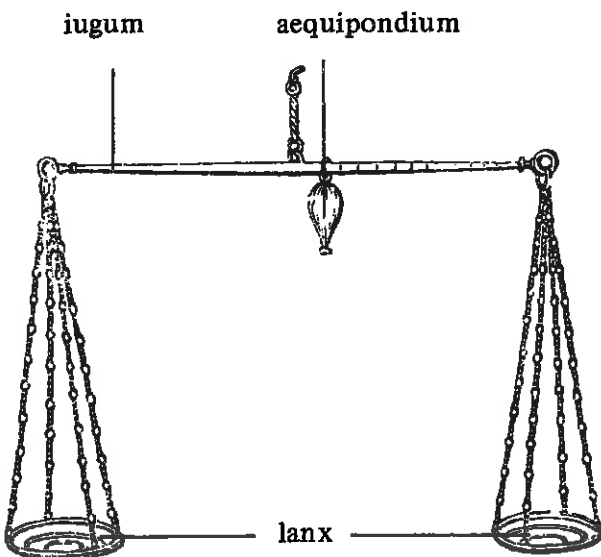

## Liburnica (vel Liburna)

sc. navis. est genus navigii velocioris, variae magnitudinis, nam minima unum habebat remorum ordinem, paulo maior binos. dicta est a Liburnis, populo Illyrici, quorum auxiliis cum usus fuisset Augustus bello Actiaco contra Antonium et Cleopatram, et experimento didicisset eorum naves ceteris aptiores esse, classem Romanam ad illarum exemplum restituit et ipse et ceteri deinceps imperatores. imago sumpta est e nummo cuiusdam imperatoris.

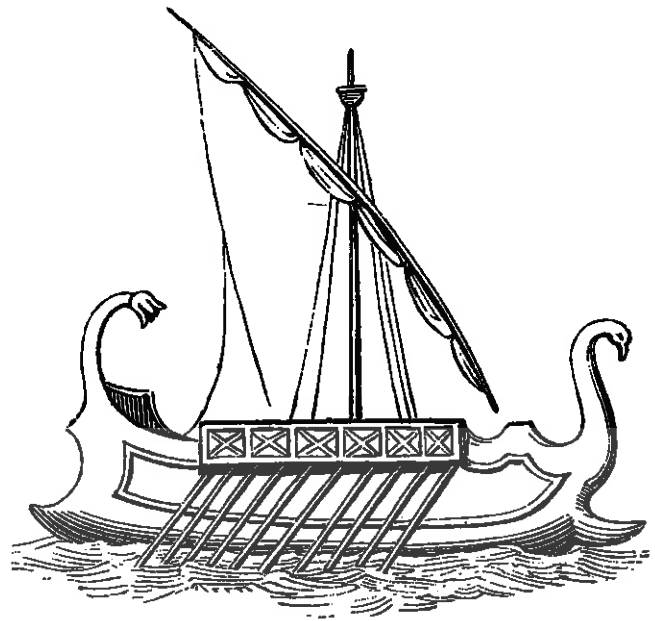

## lictor –oris, m.

fascem (fascis) virgarum ligatum fert. lictores consules et praetores comitantur; numero lictorum et fascium eorum potestas indicatur. fascis securis est virgis conligatis circumdata (*miles Romanus*).



**ligo** -onis, m.

ligo est instrumentum rusticum lato ferro, herbis ac radicibus evellendis, purgandoque agro et terrae fodiendae aptum.

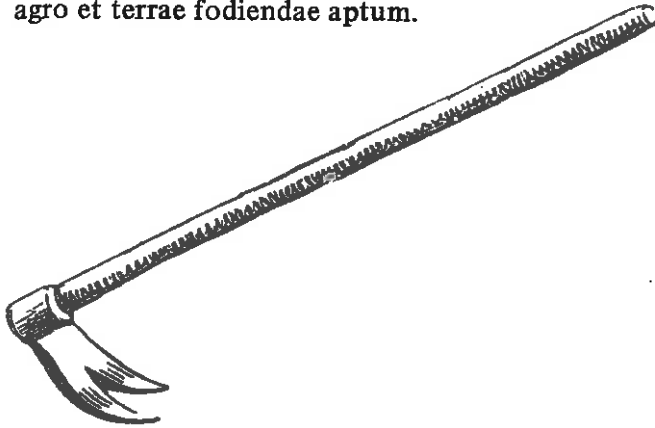

**lima** -ae, f.

est instrumentum fabrile, densis minutisque dentibus, quo ferrum aliudve quid terendo expolitur.

**limare:** perpolire, expolire, perficere, eliminare, ad perfectum unguem castigare; **limae labor:** offendit poetas limae labor (Horatius).

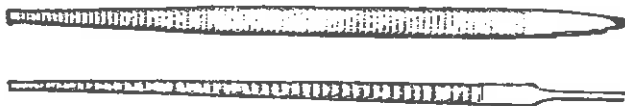

**limen** -inis, n.

est lignum aut lapis transversus in ianua aut porta, tum superius tum inferius.

religiosum erat limen aedium, quod propterea abeuntes redeuntesque salutare solebant:

**Plautus, Mercator 830:**

„limen superum inferumque, salve ...“

**limes** -itis, m.

est semita transversa, tum in agris, tum in urbibus, sed stricto sensu in agris.

his limitibus agri divisi erant, ut et mensurae et itineris et laboris causā pervii essent. limitibus agrorum fines distinguuntur.

limites etiam dicuntur Romanorum aggeres munitionesque ad Rhenum et ad Danuvium.

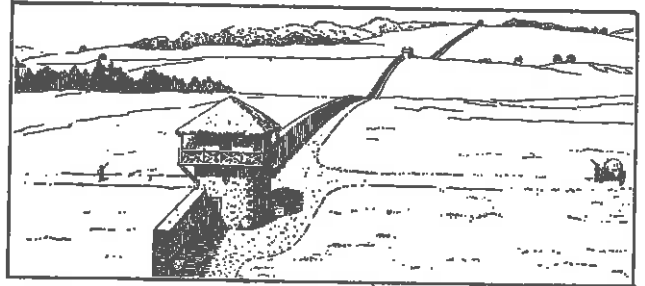

limes Rhaeticus

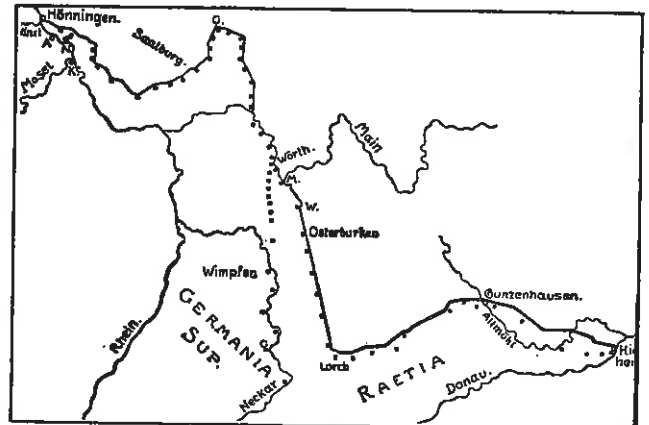

limes Romanus in Germania Superiore et in Rhaetia

limes Germaniae Superioris

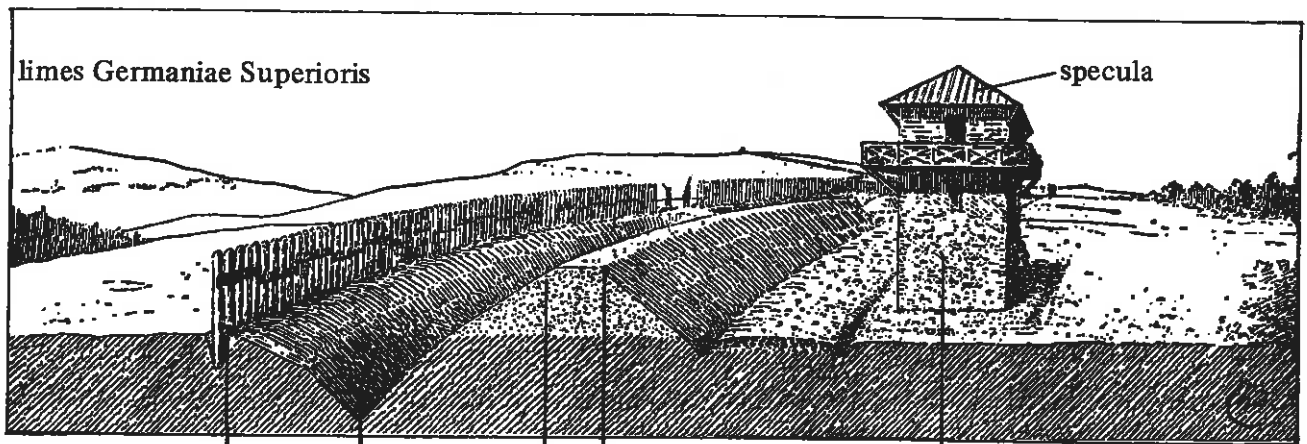

vallum

fossa

agger cum limite

turre

**linter** –tris, f.

linter est cymba parva ex cavatā arbore, vel etiam ex pluribus asseribus compactis, in usum traiciendi fluminis.

Livius, 21, 26, 8:  
„novas (lintres) ... cavabant ex singulis arboribus.“



linter = navicula monoxylos, i. e. ex singulā arbore facta

**litus** –oris, n.

litus est terra adiacens mari, quae fluctibus alluitur; dicitur etiam de terra litori vicina.

Catullus, 71, 4:  
„litus tunditur undā.“  
**proverbium**: „in litus arenas fundere“, idem significat quod „ligna in silvam gerere.“  
(*paeninsula*)

**lituus** –i, m.

a) lituus est baculus incurvus, quo augures sedentes avibus *templum* designabant.  
Livius, 1, 18, 7:  
„dextra manu baculum sine nodo aduncum tenens, quem lituum appellaverunt.“  
\*\*similis lituo est nunc episcoporum baculus.

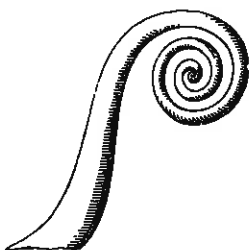

b) a similitudine litui auguralis est genus tubae minoris, incurvum, acutum edens sonum, quo in bello utebantur. (*instrumenta musica*)

Lucanus, 1, 237:  
„stridor lituum clangorque tubarum.“

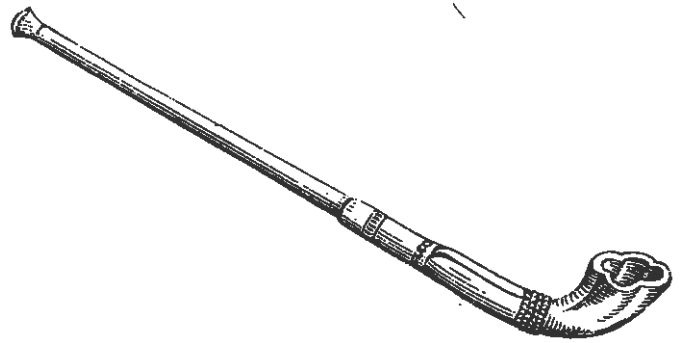

**locus adverbia loci**

ubi? ○  
quo? →  
unde? ←-----

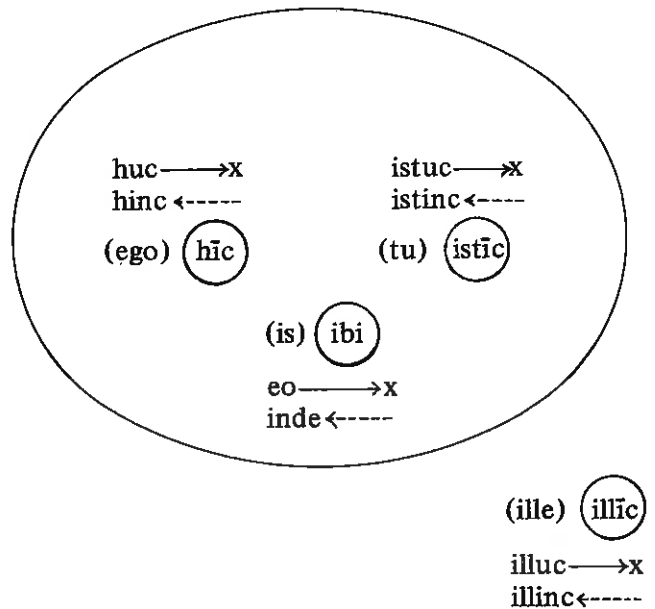

ellipsis communicationis duos focos habet: ego et tu. res, de qua loquimur, aut in ellipsi (is, ea, id) aut extra ellipsim (ille, illa, illud) sita est. omnes res, quas demonstramus, ad unam harum positionum referuntur, sed etiam rerum motus. (*quorsum*)



## lucerna —ae, f.

e materiā fictili aut ex aere facta, oleo impleta est, unum, duo aut plura ellychnia habet. lucerna pensilis catenā sustenta e tecto pendet.

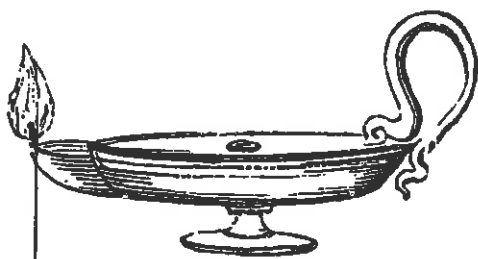

ellyphnium

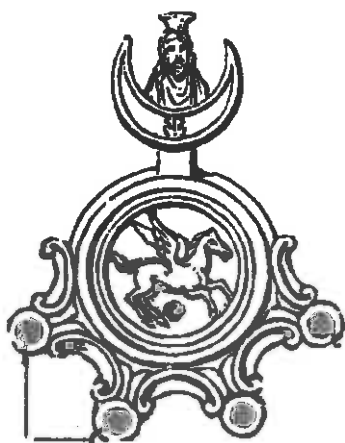

ellyphnium

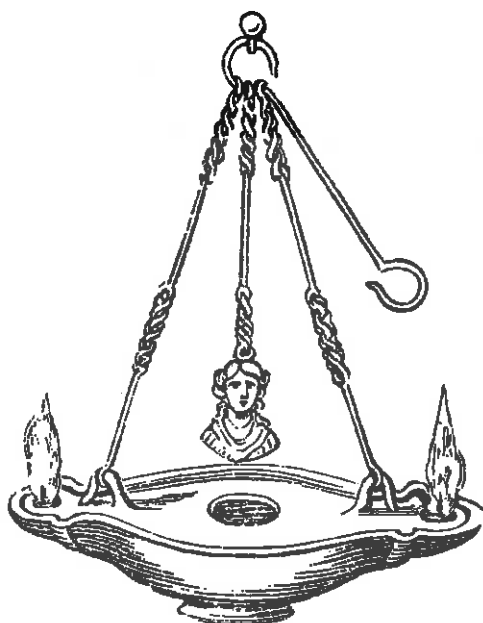

lucerna pensilis

## lucus —i, m.

lucus est locus arboribus consitus et religione sacer.

Vergilius, Aen. 6, 673:

„nulli certa domus, lucis habitamus opacis.“

Servius ad locum:

„heroum animae dicuntur lucos tenere.“

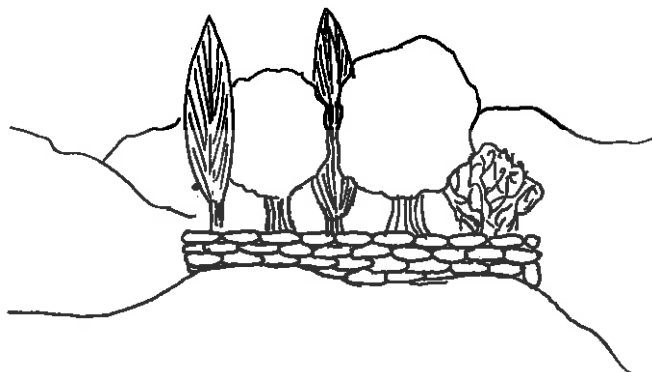

## ludus —i, m.

ludus est exercitatio quaevis animi vel corporis recreandi causā suscepta.

Cicero, de orat. 3, 15, 58:

„ad pilam se aut ad talos aut ad tesseras conferunt, aut etiam novum sibi ipsi aliquem excogitant in otio ludum.“ (*pila, talus, tessera, trochus, turbo*)



draco volans



saltus ad funem



rotula saltans



rotula Athenis inventa



sectio rotulae

**Porphyrio ad Hor. carm. 1, 9, 21:**

„puellae solent ... abscondere se quaerentibus amatoribus et rursus ut inveniantur risu se prodere.“

metonymice ludus est locus, in quo corporis aut ingenii vires exercentur, ut palaestra et schola.



tres genii ālāti se abscondendo ludunt: unus eorum oculos manibus tegit dum ceteri se abscondunt ut postea a primo inveniantur.

## luna -ae, f.

phases lunae

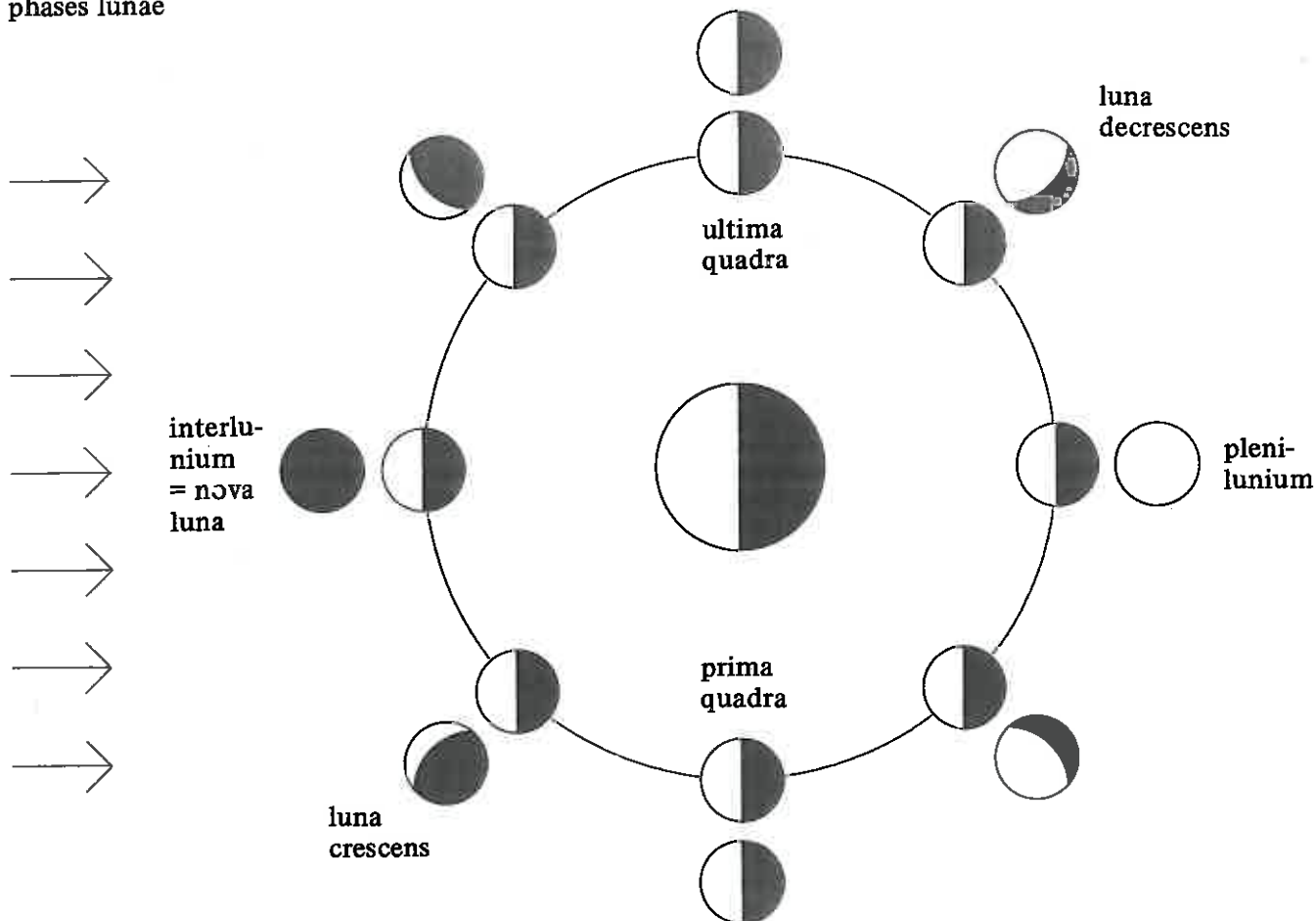

**lupa** –ae, f.

---

**lupa** est femina in genere luporum. narrant Remum Romulumque **geminos** in silvā expositos nutritos esse a lupā lactante. (**lactare**)

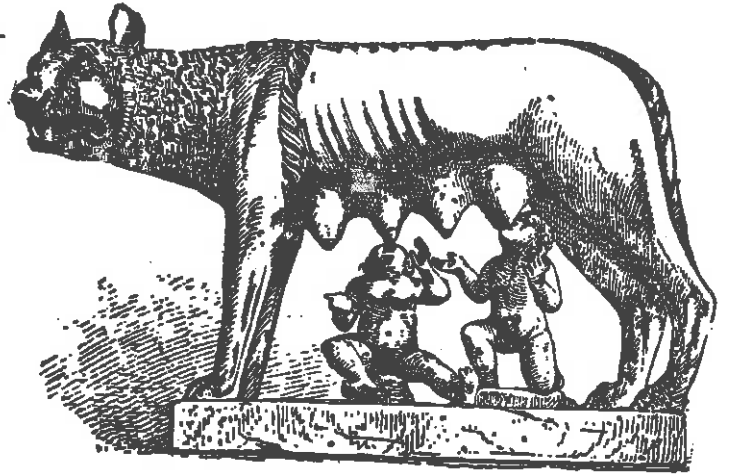

**lupa** quae dicitur **Capitolina**. Romulus et Remus lactentes uberibus lupae inhiant (**lactere**). haec imago lupae opus est Etruscum, **gemini** posteriore tempore adiuncti sunt



est locus, ubi macellarius carnes qualescumque coquit et vendit.  
in opere caelato sarcophagi (*sarcophagus*), qui Romae in Musaeo Torloniano monstratur, est *taberna* macellaria, ubi in pariete (*paries*)

*lepores*, *anser*, *vulpes* aliaeque bestiae pendent. saepe in macello etiam coqui diebus festis conducebantur ut domi cenas maximas pararent, sicut in Aululariā Plautinā.

maeandrus —i, m.

Maeandrus est fluvius ingens Asiae in Phrygia Magna, crebris ita sinuosus flexibus, ut saepe credatur reverti.

etiam opus penicillo (penicillus) aut acu (*acus*) factum ad similitudinem Maeandri, flexuoso et in se remeabili gyro descriptum.

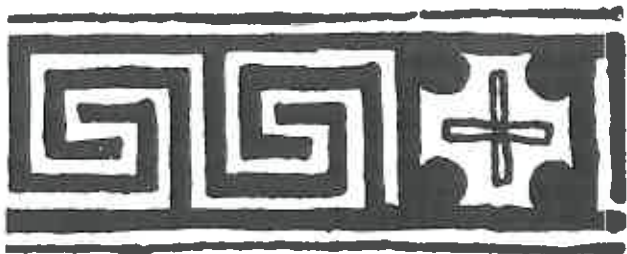

## maiestas —atis, f.

est magnitudo, amplitudo, decus, dignitas deorum, populi dominatoris vel senatus, vel principis imperatorisve, aut etiam privati magni viri; ob quam honos illi et reverentia debetur.

\*\*maiestas domini nominatur ea imago Christi, quae in solio aut in arcu (*arcus*) Iridis supra mundum sedet tamquam rex universitatis; corpus eius soliumque nimbo (*nimbus*) circumdatum est; in quattuor angulis symbola (*symbolum*) evangelistarum, quattuor elementa aut quattuor venti eum comitantur.



maiestas Domini e codice Medii Aevi

## malleus —i, m.

malleus est fabrile instrumentum ad tundendum.

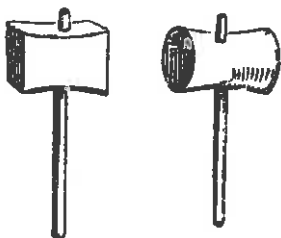

## manica —ae, f. (vel manicae —arum)

a) manica est pars vestis, qua brachia et manus teguntur.

b) manicae sunt vincula, quibus manus ligantur, sicut pedicae, quibus pedes ligantur. (*compedes*)

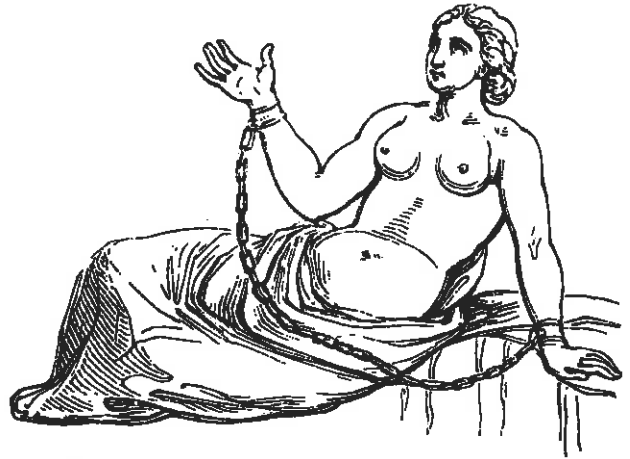

## manipulus —i, m.

Isidorus, Orig. 18, 3, 5: manipulus est „manualis herbarum fasciculus, quem manu quis apprehendit metendo.“

Vergilius, Georg. 3, 297/298:

„filicumque maniplis sternere humum.“

in re militari manipulus erat exiguum peditum agmen, quod unum *signum* sequebatur.

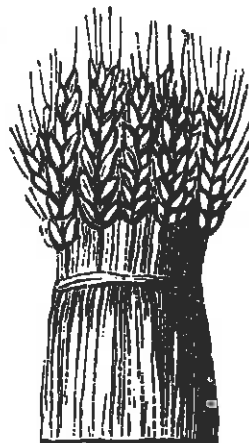

## mansuetarius —i, m.

mansuetarius est qui feras cicurat et mansuetas reddit; domitor ferarum.

Historia Augusta 17, 21:

„habuit et leones et leopardos exarmatos in deliciis: quos edoctos per mansuetarios subito ad secundam et tertiam mensam iubebat accumbere, ignorantibus cunctis, quod exarmati essent.“



### manumissio –onis, f.

est datio libertatis. servi cum liberarentur potestate, e manu solemniter emittebantur. lictor servum genibus nixum vindictā (aut fistucā) tangit dicens: „hunc hominem ex iure Quiritium liberum esse volo.“  
servus pileum (*pileus*), signum libertatis, sumit; nam „capere pileum“ idem est quod „libertate donari“.

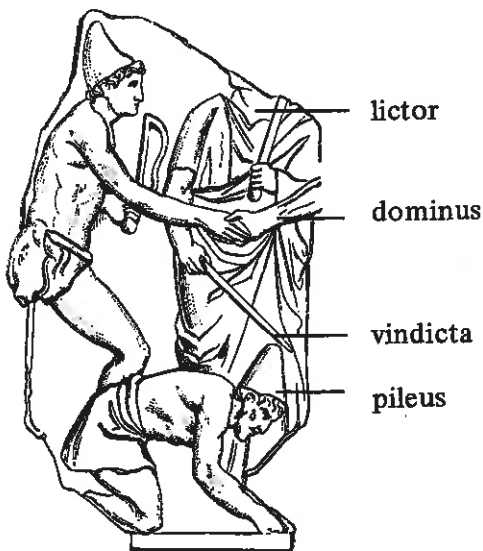

in opere caelato nostro figura domini deleta est; lictor in medio situs vindictam manu dextrā tenet

### mappa –ae, f.

a) mappa est idem quod linteum, tegumentum, stramentum, vel mantele, manutergium in usu convivantium.

b) mappa dicitur etiam de pannis ad varios usus adhibitos: mappā consules initium ludorum significabant (ut monstratur in imaginibus adpositis).

c) mappa etiam genus est librorum vel chartarum linteo confectum.

d) \*\*mappa mundi idem est quod charta vel tabula geographica in linteo depicta vel impressa.



statua Musei Capitolini consulem mappam gestantem repraesentat

### materia –ae, f. sive –ies –iei, f.

a) materia significat lignum arborum.

Columella, r. r. 5, 11, 4:

„cuneum ... inter corticem et materiem ... demittito.“

b) est id, ex quo fit aliud, ut materia libri charta est et atramentum, domūs lapides, ligna, calx et cetera.

Cicero, nat. deor. 3, 39, 92:

de materiā rerum, „ex quā et in quā omnia sint.“

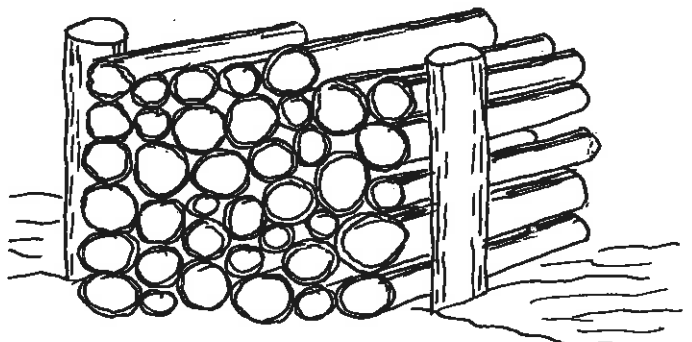

## Mausoleum –i, n.

a) sepulcrum regis Asiae, Mausoli, quod inter septem mirabilia mundi numerabatur.

b) monumentum sepulcrale sumptuosum, ut sepulcrum Augusti aut Hadriani imperatoris. Mausoleum Hadriani quod hodie Arx Sancti Angeli nominatur. monumentum longe maius et ornatius erat Mausoleum Hadriani, ex quo unica tantum, sed immanis magnitudinis turris superest, quae Romae in castello (castel-

lum) Sancti Angeli arcis munitissimae speciem praebet.

olim hoc aedificium sublimibus undique columnis (columna) erat exornatum ut in reconstructione videtur. columnarum hodie octoginta in ecclesia S. Pauli extra muros conspiciuntur. loco immanis quadrigae hodie statua Sancti Angeli posita est, quae monumento hodiernum nomen Arcis Angeli dat.

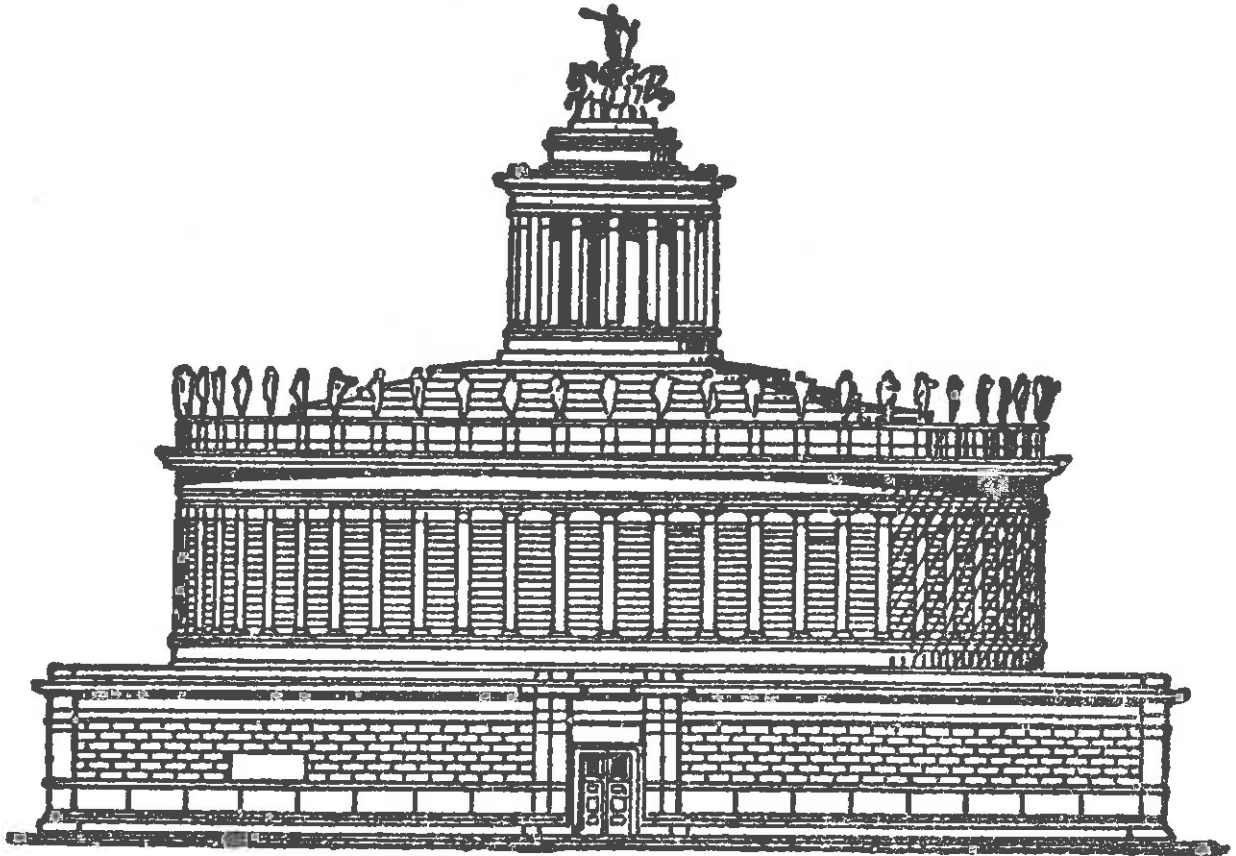

## ensor –ris, m.

a) ensor est qui aliquid metitur (metior, mensus sum, metiri)

caeli ensor est astronomus,

terrae ensor geometra.

(artes liberales, geometria)

Horatius, carm. 1, 28, 1–2:

„te maris et terrae, numeroque carentis  
arenae

mensorem cohibent, Archita ...“

b) ensor agri est agrorum finitor.

Ovidius, met. 1, 136:

„cautus humum longo signavit limite (limes)  
ensor.“

instrumentum agri ensoris est groma, qua  
flexae viae ad lineam diriguntur.



groma



monumentum funebre  
agri mensuris, eius  
instrumenta ostendens:  
*bisellium, fasces,*  
*gromam, perpendicula*  
*(perpendiculum)*

**mensura** –ae, f.

a) est actio, qua quippiam metimur, seu quanti-  
tatem rei cuiuspiam deprehendimus.

b) est instrumentum, quo quippiam metimur, seu  
quantitatem rei cuiuspiam deprehendimus;  
item ipsa quantitas, modus, magnitudo cuius-  
que rei.

Plinius, H. N. 7, 198:

„*mensuras et pondera (pondus) invenit Phidon*  
*Argius vel Palamedes.*“

c) in pictura est convenientia et proportio  
partium.

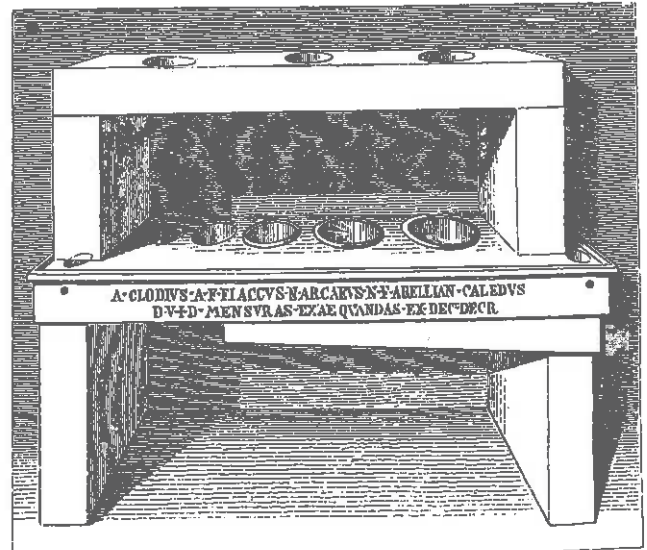

*mensurae publice praescriptae*



*mensurae et pondera illustrantur in Olai Magni Historia de Gentibus Septentrionalibus*



mensurae longitudinis:

sumptae sunt mensurae longitudinis e membris corporis humani (*corpus humanum*) eorumque motibus:

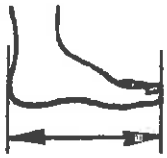

pes pedis, m. = 0,29 m

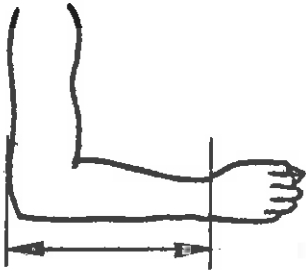

cubitus -i, m. = 0,44 m  
(vel cubitum -i, n.)

gradus -ūs, m. = 0,74 m

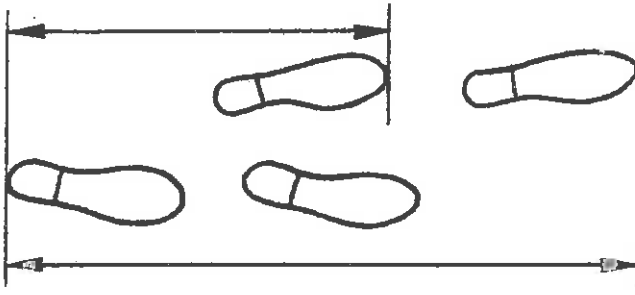

passus -ūs, m. = 1,48 m

mille passuum = 1478,7 m  
decem milia (passuum) = 14787 m

mercator -is, m.

mercator est qui merces vendit, mercatur. (*institor*) (*caupo*).

Caesar B. G. 6, 17:

„deum maxime Mercurium colunt; ... hunc ad quaestū pecuniae mercaturasque habere vim maximam arbitrantur.“

in oppidis antiquis, ut saepe etiam hodie, mercatores et artifices eiusdem generis in eodem vico professionem suam exercebant: vicus frumentarius, vicus lorarius, vicus materiarius, vicus unguentarius, vicus thurarius, vicus argentarius, clivus vitriarius et alii.



mercator pomarius per vias ambulat et poma vendit clamitans: „māla, mulieres, mulieres meae!“

mercatus -ūs, m.

mercatus est mercandi actus; ponitur etiam pro loco (i. e. emporio), ad quem mercatores emendi vendendique gratiā conveniunt.

Cicero, de invent. 2, 4, 14:

„in itinere quidam proficiscentem ad mercatum ... est consecutus.“

merces (*merx*) sunt res, quae emuntur venduntur.

Ovidius, ars am. 1, 419s:

„institor ... expediet merces ... suas.“

Plautus, Poenulus 342:

„proba merx facile emptorem reperit, tametsi in abstruso sita est.“



mercatus Romanus in picturā murali Pompeianā: sinistrā institor merces suas in tabulā ostendens, dextrā sutor feminis calceos aptans

**messis** –is, f. (acc. –em/–im)

messis est actus metendi vel secandi, speciatim est collectio frumenti et aliarum segetum.

**messor** est is, qui metit.

**Ovidius**, Heroid. 16, 263:

„sed nimum properas; et adhuc tua messis in herba est.“



**meta** –ae, f.

a) meta est quidquid ita est acervatum vel congestum, ut conus (conus) formam referat, ut exempli gratiā conus foeni.

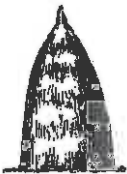

conus foeni

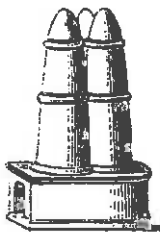

**Cicero**, divin. 2, 6, 17:

umbra „terrae quae est meta noctis.“

b) metā signabatur in circo (circus) locus flec-tendi quadrigas.

**Horatius**, A. P. 412:

„qui studet optatam cursu contingere metam, multa tulit fecitque puer ...“

c) meta etiam dicitur finis.

**Vergilius**, Aen. 1, 278:

„his ego nec metas rerum nec tempora pono.“

**meta destillatoria** est conus vitreus destillandis liquoribus aptus:

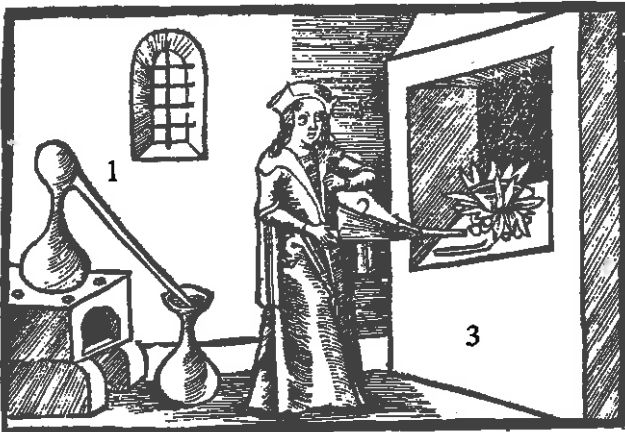

alchymistae officina, metam destillatoriam (1), follem (2) (follis) et fornacem (3) (fornax) monstrans. imago sumpta est e Margaritā Philosophicā Gregorii Reisch

**mica** –ae, f.

est frustulum alicuius rei, v. gr. mica panis, item minutum granum salis, turis, item minutissi-



figura in vase Graeco: duo Cupidines, qui digitis micant.

mum auri ramentum, ut quae in harena refulgent.

**Caelius Aurelius**, Tard. 1, 4:

„item velut scintillarum micas, aut circulos igneos circumferri prae oculis sentiunt aegrotantes.“

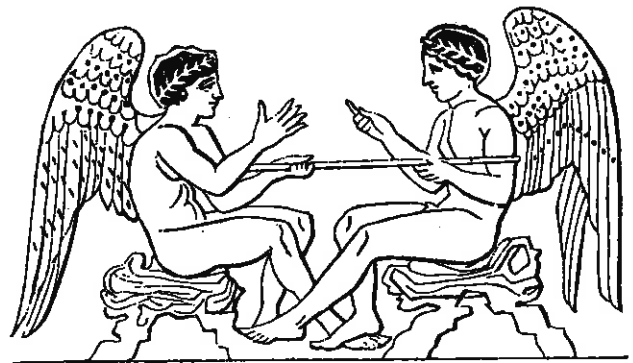
**micare**

significat tremulum esse, corruscare, crebro celerique motu agitari, subsilire, vibrari, concuti.

**Ovidius**, Fasti 3, 36:

„terreor admonitu: corda timore micant.“

speciatim: **digitis micare** est digitis sortiri: cum porrectis invicem crebro digitis, certantium uterque numerum eorum divinat.

**Cicero**, de div. 2, 41, 85:

„quid enim sors est? idem propemodum, quod micare, quod talos iacere, quod tesseras.“

**proverbium**: cum alicuius fidem bonitatemque laudant rustici homines, proverbio dicunt, „dignum esse, quicum in tenebris mices.“

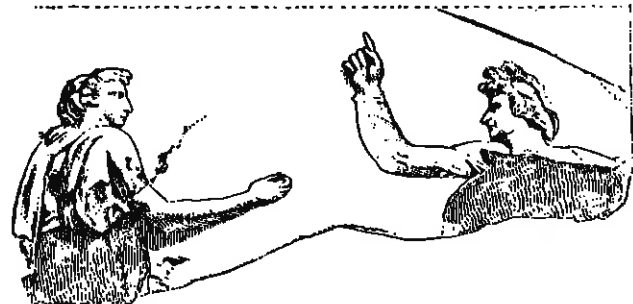

duo iuvenes digitis micant

# miles Romanus

vestimenta, arma, insignia:

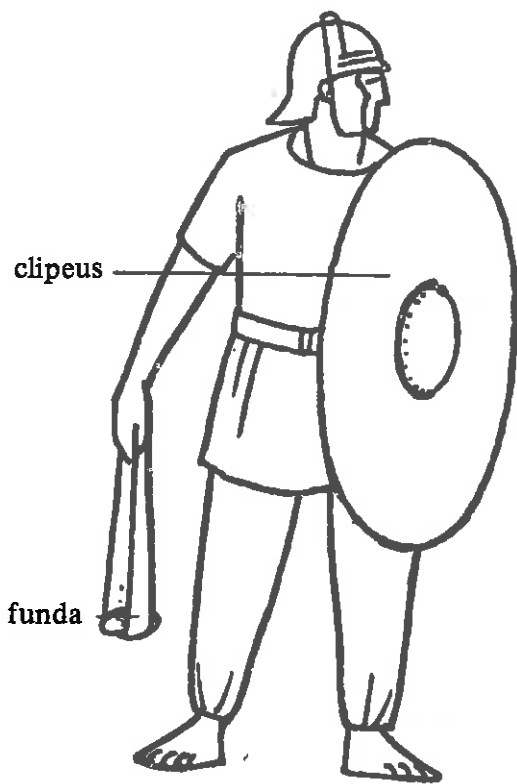
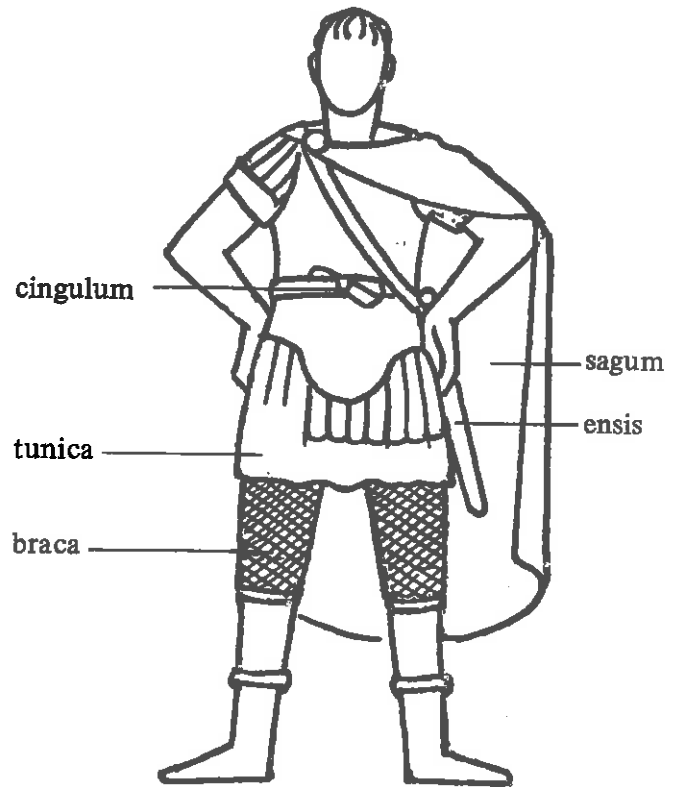
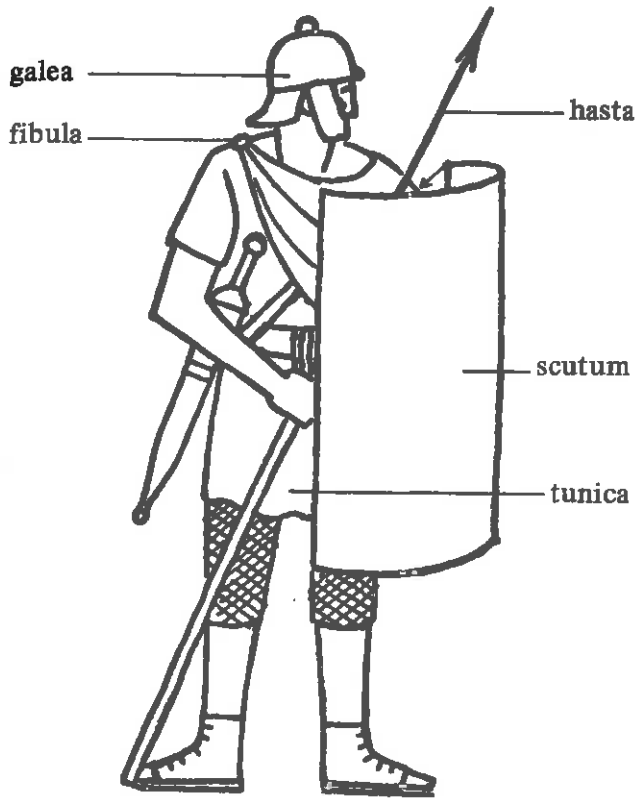

funditor

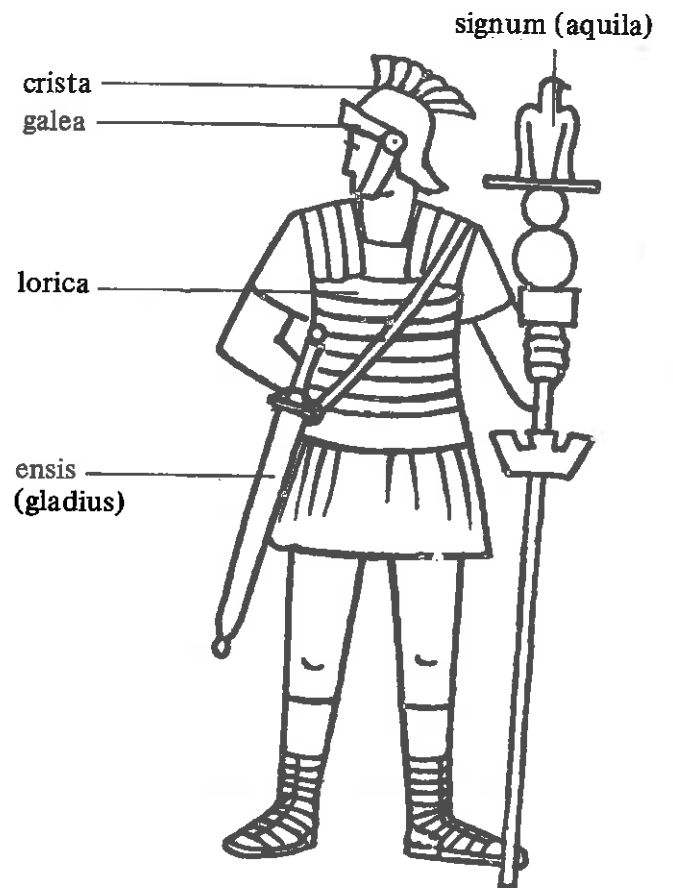

signifer (aquilifer)



galea

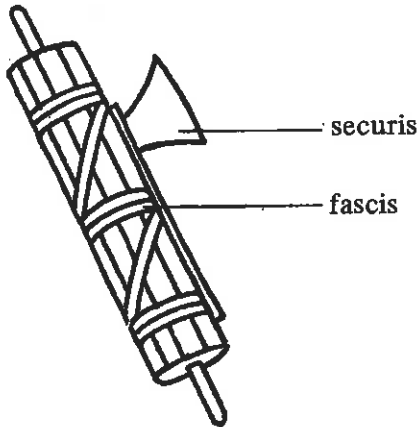

securis

fascis

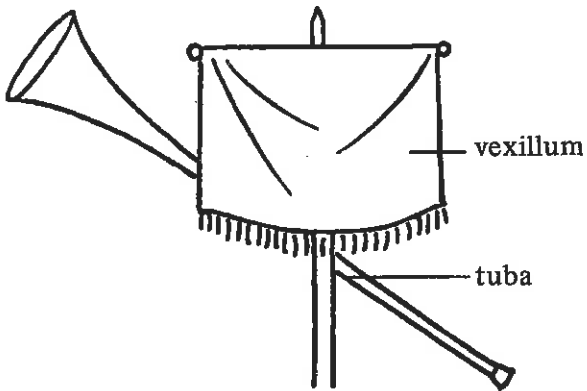

vexillum

tuba

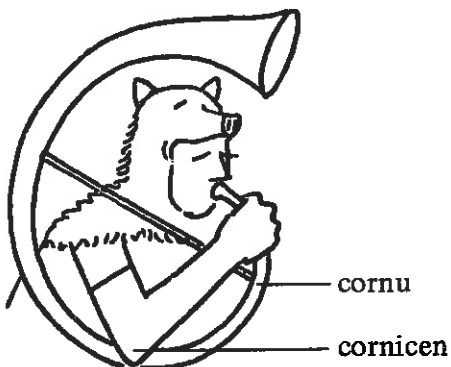

cornu

cornicen

## miliarium -i, n.

est columella seu lapis erectus in viis, praesertim militaribus, inscriptas habent notas, quibus milia quaeque passuum significantur. Hos lapides miliarios omnium primum in viis posuisse C. Gracchum narrant...

miliarium aureum appellata fuit columna ab Augusto in capite Romani fori prope aedem Saturni statuta, in qua omnes viae ab urbe Roma in Italiae provincias ferentes descriptae fuerunt.

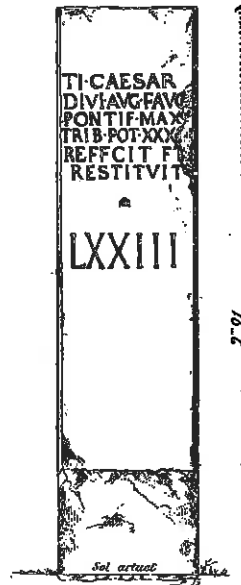

miliarium Tiberii

## mimus -i, m.

mimus est gesticulator, imitator factorum dictorumque ac morum alienorum, colligendi risus causā, in scaena vel extra (a verbo Graeco mimeisthai = imitari).



minio –as, –atum, –are / \*\*miniatura, –ae, f.

miniare est minio tingere. cera miniata vel miniatula, erat cera rubra, qua notabant, quae minus probarent et corrigi vellent. Cicero, ad Atticum 15, 14, 4: „quae quidem (litterae) vereor, ne miniata

cerula tua pluribus locis notandae sint.“  
\*\*miniatura, –ae, f. dicitur delineamentum minio (= rubro colore) in codicibus Medii Aevi praescriptum, quod postea variis coloribus ornatur.

## Mithraeum –i, n.

est spelunca vel *camera* subterranea, in qua sacra Mithrae fiebant. Mithra (–ae, m.) autem erat apud Persas idem habitus ac sol. eius mystae septem gradibus (gradus) initi-

ationem perfererunt, ut in imagine Ostiae reperta videtur, in qua scala septem graduum initiationis monstratur.

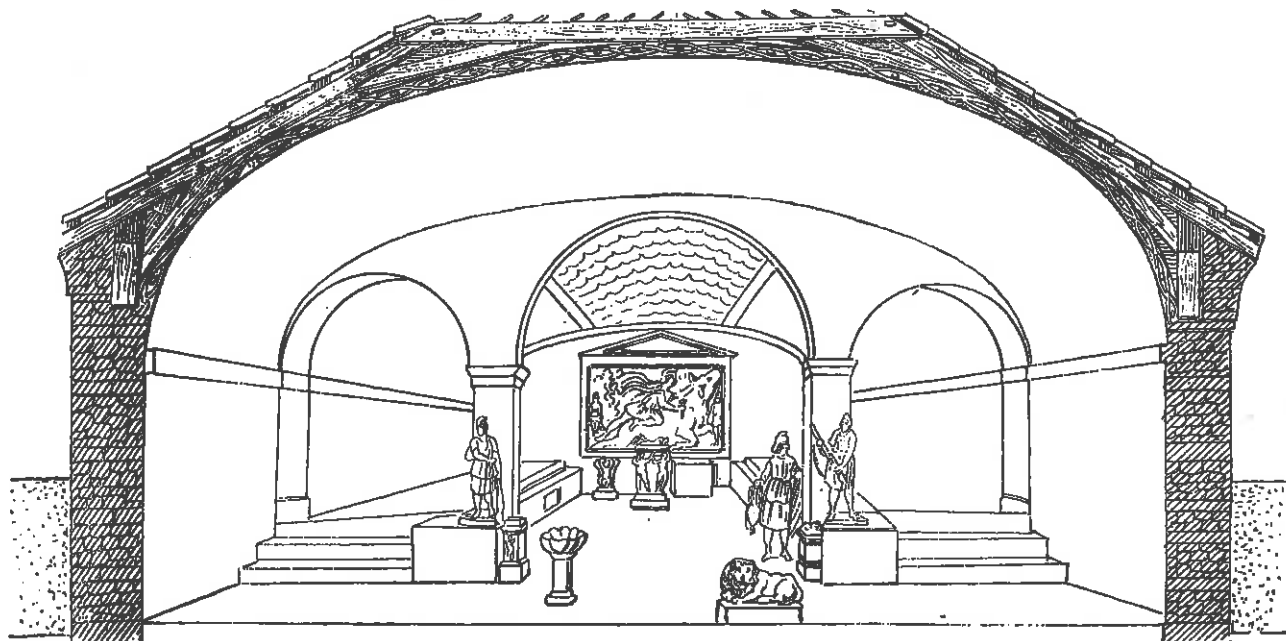

Mithraeum Carnunti repertum (reconstructio)

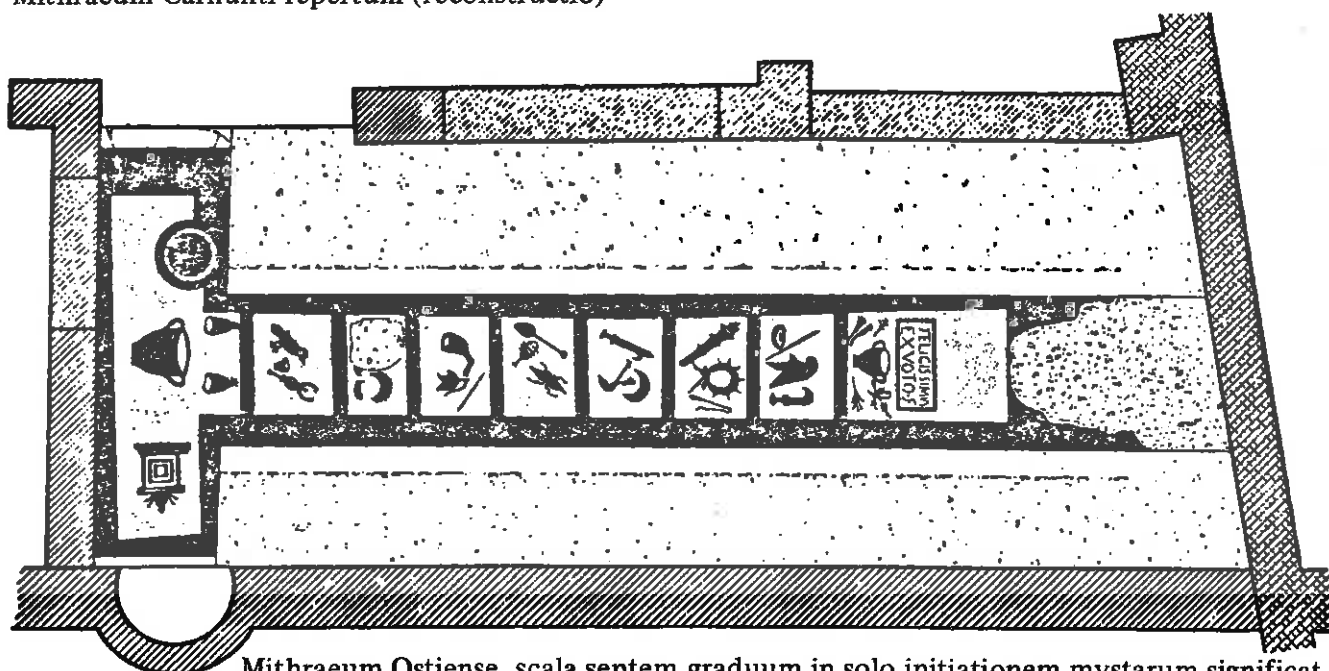

Mithraeum Ostiense. scala septem graduum in solo initiationem mystarum significat.

## mola -ae, f.

mola est machina, qua molinarum utuntur ad molendum (molo, -ui, -itum, -ere) frumentum.

erant molae hominum aut bestiarum vi actae, vel molae aquariae, quae impetu fluminis versabantur. molae ventorum vi actae primae in Europa inveniuntur saeculo nono p. Chr. n. in Britannia.

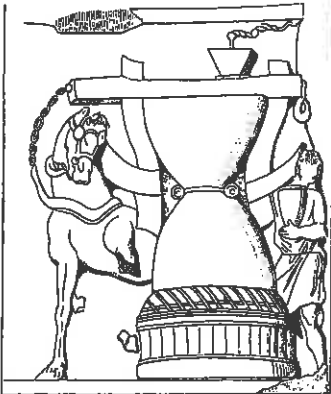

mola equo acta, ex opere caelato in Musaeo Chiaramonti, Romae, exposito

mola aquaria vi fluminis agitur. nam rota pinnis instruitur, quae, cum percutiuntur impetu fluminis, cogunt versari rotam. huius, ut explicat Vitruvius 10, 5, 2: „in uno capite axis (2) tympanum dentatum (3) est inclusum. id autem ad perpendicularum conlocatum in

cultrum versatur cum rota (1) pariter. secundum id tympanum maius item dentatum (4) planum est conlocatum, quo continetur. ita dentes tympani eius (3), quod est in axe (2) inclusum, impellendo dentes tympani plani (4) cogunt fieri molarum (5) circinationem. in qua machina impendens infundibulum (6) subministrat molis frumentum et eadem versatione subigitur farina.“

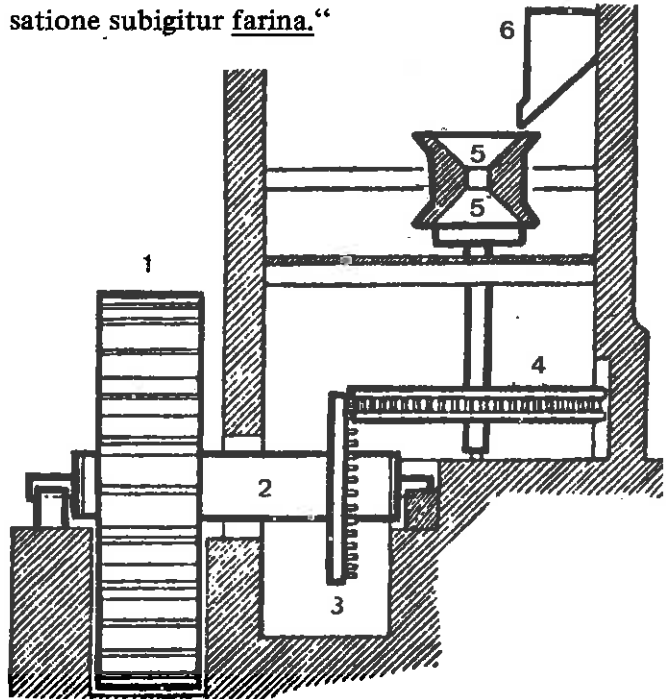

## Moneta -ae, f.



monetarii in officina, ex Olai Magni opere

a) fuit cognomen Iunonis, quia Romanos monuisse credita est, ut propter terrae motum suae plena rem divinam facerent (Cicero, Div. 1, 45, 101).

b) moneta est templum, sive locus, in quo pecunia cuditur.

#### monetarius

est is, qui monetam cudit, qui in moneta publica operatur. huiusmodi artificum corpus quoddam Romae fuit.

### monile –is, n.

monile est ornamentum colli ex auro aut margaritis aut gemmis (*gemma*), proprium feminarum, cum *torques* sit hominum.

Cicero, Verr. 2, 4, 39:

„Eriphylam accepimus in fabulis eā cupiditate, ut cum vidisset monile, ut opinor, ex auro et gemmis, pulchritudine eius incensa salutem viri proderet.“



### Monumentum Ancyranum

est inscriptio (*titulus*) Caesaris Augusti, cuius exemplar Ancyrae (hodie Ankara) repertum est in templo Augusto consecrato. inscriptio in tabulis indicat res ab Augusto gestas. („Res gestae Divi Augusti“) veri simile est has tabulas paulo post mortem Augusti exaratas esse et verba ipsius imperatoris continere. alibi in Imperio Romano multae tabulae eiusdem generis exstistisse dicuntur. hoc est initium inscriptionis:

„annos undeviginti natus exercitum privato consilio et privatā impensā comparavi, per quam rem publicam a dominatione factionis oppressam in libertatem vindicavi ...“

### mortarium –i, n.

est vas, in quo res, quae resolvendae sunt, pistillo (*pistillum*), vecte, aut manibus teruntur subigunturve. materia mortarii est marmor, lignum, testa, aes, aliaque.

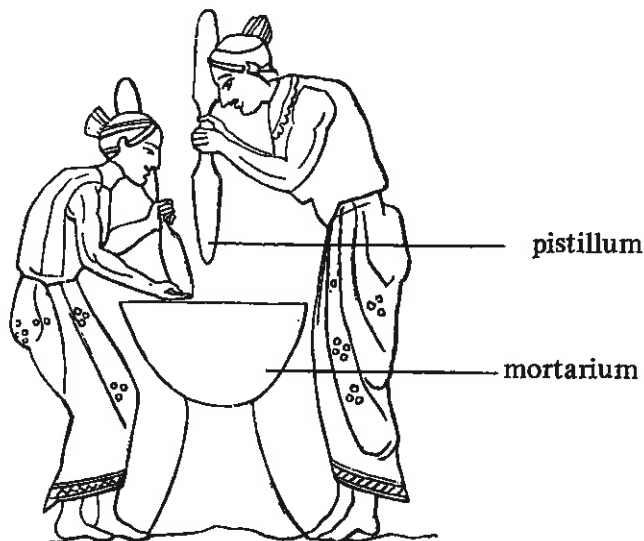

Cato, r. r. 74:

„farinam in mortarium indito, aquae paulatim addito, subigitoque pulcre.“

Columella, r. r. 12, 57, 1:

„semen sinapis ... duabus horis in aqua sinito, postea tollito, et manibus expressum in mortarium novum conicito, et pistillis conterito.“

### mulctrum –i, n. (vel mulctra –ae, f.)

mulctrum est vas in quo lac mulgetur.

Calpurnius, Ecl. 4, 25:

„duc ad mulctra greges.“

verbum: mulgeo, mulsi, mulctum, mulgēre.

proverbialiter: „hircos mulgēre“, aliquid conari, quod fieri nullo modo potest.



## murex –icis, m.

- a) murex est molluscum ex genere concharum, qui et bucinum dicitur. ex eius suco olim color purpureus fiebat; unde et pro purpura et pro ipso colore accipitur.  
b) speciatim est testa huius animalis; concha murex dicitur, qua oleum, unguentum etc. servatur.



Triton murice canens

- c) item tuba, qua utuntur Tritones, quae et concha appellatur.  
d) murex ferreus est instrumentum ferreis instructum cuspidibus, tetragona forma, quod in quamcumque partem inciderit, aculeos protendit; in terram dolose conici solet, ut iis hostilis equitatus ingruens induatur.

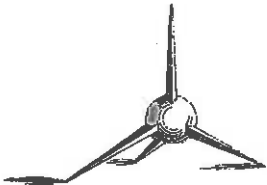

murex ferreus

## Musae –arum, f. pl.

Musae sunt deae, filiae Mnemosynes (Memoriae), quae poeticae et musicae ceterisque artium liberalium disciplinis (artes liberales) praesunt: qua re frequentissime eas invocant poetae.

Clio historiae praeest, Euterpe tibiis, Thalia comoediae, Melpomene tragoediae, Terpsi-

## musca –ae, f.

musca domestica insectum est e genere dipterorum.

muscarium est flabellum, quo muscae molestae abiguntur.

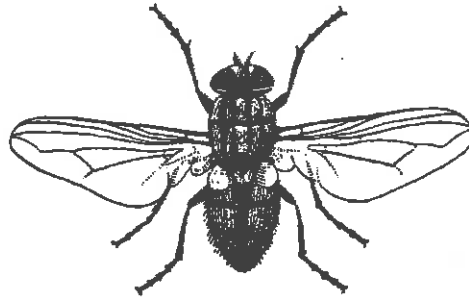

## muscipula –ae, f. sive muscipulum –i, n.

est instrumentum ad capiendos mures (mus)

Varro, r. r. 1, 8, 5:

„Nec non si parit humus mures, minor fit vindemia, nisi totas vineas oppleris muscipulis, quod in insulā Pandatariā faciunt.“

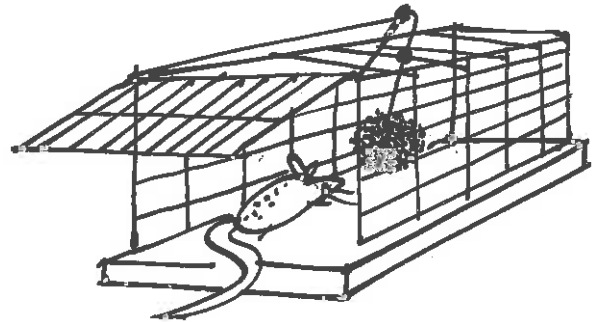



**muscus** —i, m.

---

muscus est villosa illa lanugo, quae in arboribus ac saxis provenit, qualem videmus circa fontes (*fons*) et loca humida, qualis etiam est illa, quae in mari petris innascitur ac mari innatat, unde et in litus evolvitur ac proiicitur, quae aliter „alga.“ dicitur.

adi. muscosus, —a, —um = musco abundans, musco obsitus: muscosi fontes.



**muscus hepatica**



**muscus**

nassa —ae, f.

est vimine textum vas piscatoris (*piscator*),  
quo cum intravit piscis, exire non iam potest.



piscatores e *scapha* nassas in aquam demittunt.  
opus tessellatum in Africa Septentrionali (Sousse)  
inventum

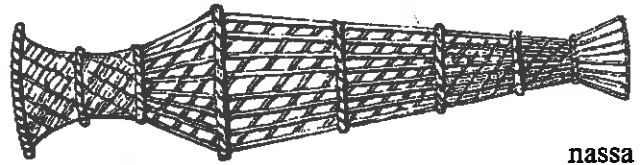

nassa

nassiterna —ae, f.

est genus vasis  
aquarii ansati  
et patentis, quale  
est quo equi  
perfundi solent.  
usurpatur etiam  
ab hortolanis ad  
plantas irrigandas.

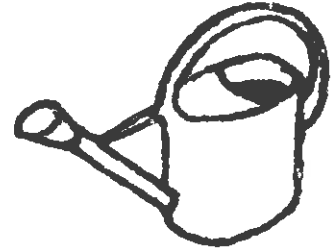

naumachia —ae, f.

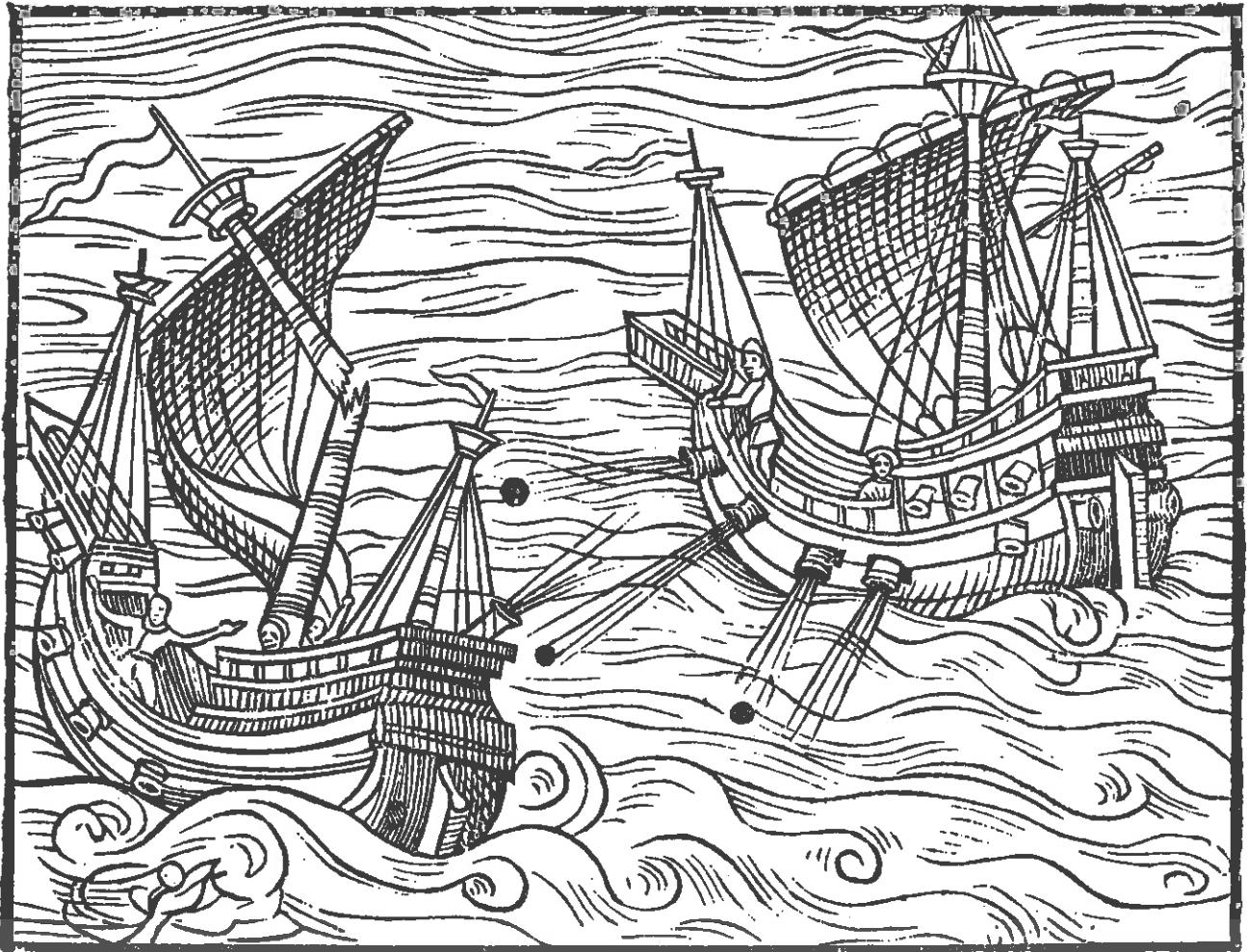

naumachia (pugna navalis) pro portibus Islandiae, describitur in opere Olai Magni

est pugna navalis. dicitur etiam de ludicris pugnis, quae aut arte collectā aquā, aut in stagno lacuve aliquo spectaculi loco edebantur. Servius, ad Vergilii Aen. 5, 114: docet Romanos Punico bello primo naumachiam ad exercitium instituisse, postquam cognoverunt exteras gentes etiam navali certamine plurimum posse.

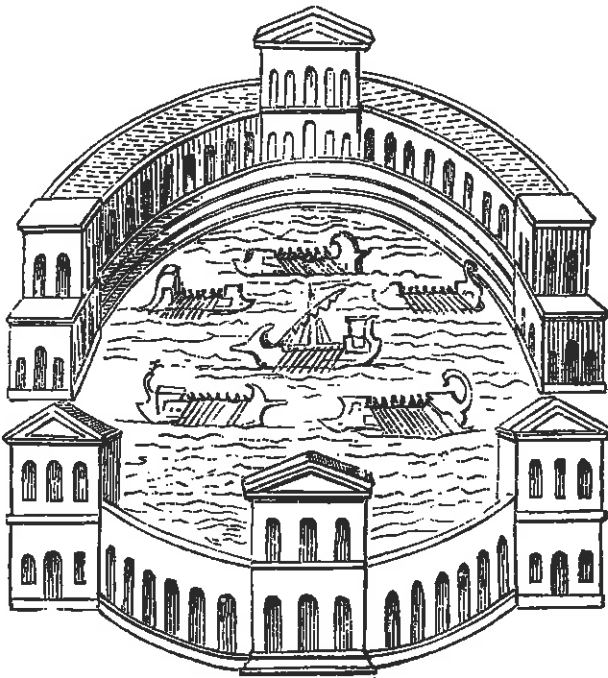

naumachia in circo (*circus*) editur spectaculi loco ut describitur in nummo quodam imperatoris

### navis –is, gen. plur. –ium f.

est machina e ligno, qua per mare, flumen, lacumve iter facimus. sunt plura genera navium, aliae sunt apertae, aliae tectae, seu constratae, sunt longae, onerariae, rostratae, fluviatiles, speculatoriae, actuariae, piscatoriae etc. locut.: navem appellere ad aliquem locum navem solvere (= ancoras (*ancora*) tollere)

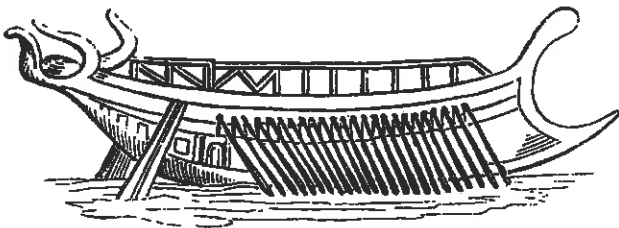

#### navis longa

est navis in pugnis navalibus utilis, uno ordine remorum acta.

navis tecta, strata aut constrata, cui navis aperta opponitur.

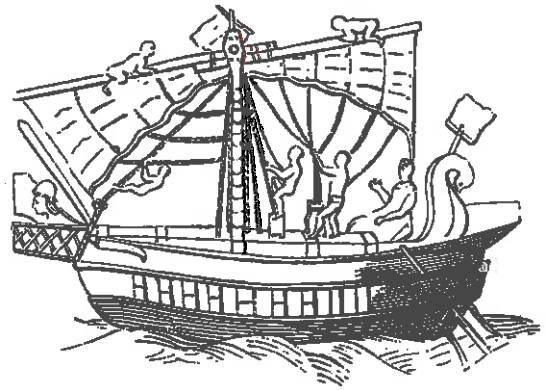

navis oneraria: navis mercatorum onera portans

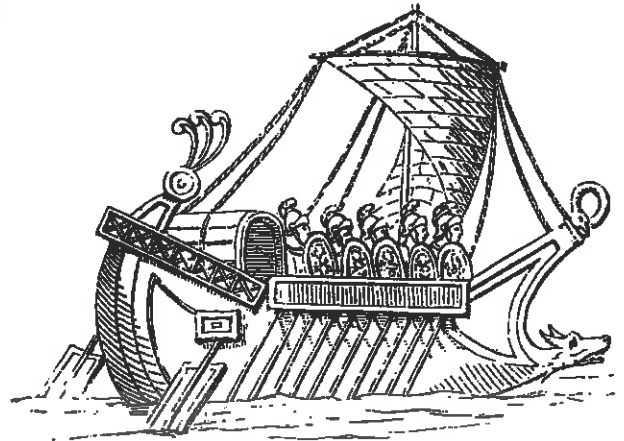

#### navis actuaria

est navis remis et velis acta, quae in bello usurpabatur.

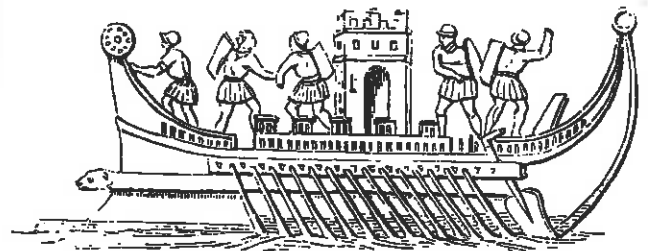

navis turrīta est navis turri instructa, e qua tela in hostes proiciebantur.

proverbium: navem perforat, qua ipse navigat.

### nimbus –i, m.

a) est pluvia repentina.

b) item est nubes splendida et splendor, qui circa caput et corpus deorum esse fingitur.

Servius, ad Vergilii Aen. 2, 616:

„est enim fulgidum lumen, quo deorum capita cinguntur: sic etiam pingi solet.“



Apollo nimbo  
praeditus



Diana cum nimbo



etiam imperatores ut dei nimbo instruuntur ut  
in hac imagine imperator Valentinianus II

c) item apud Christianos nimbus dicitur radi-  
antis splendoris *corona*, qua picta et sculpta  
sanctorum capita decorantur.

## noctua –ae, f.

noctua avis est nocturna e genere strigidum,  
quae noctu vigilat et interdiu dormit.  
deae Athenae sacra erat, itaque et urbis Athe-  
narum *insigne* erat noctua.



## nomenclator –oris, m.

est qui memoriter unumquemque nominare  
didicit.

nomenclatura –ae, f. est nomenclatio, appel-  
latio, e. gr. recitatio nominum locorum, oppi-  
dorum, fluminum, etc., quae in terra sunt.

## norma –ae, f.

est instrumentum fabrorum duabus regulis  
constans, inter se ab uno capite coagmentatis  
Latinae litterae L figuram et rectum angulum  
referentibus. rationem normae deformandae, a  
Pythagora inventam, tradit Vitruvius, 9, praef. 6:  
„si sumantur“, inquit, „regulae tres, e quibus  
una sit pedes tres, altera pedes quattuor, tertia  
pedes quinque; haeque regulae inter se compo-  
sita tangat alia aliam suis cacuminibus extre-  
mis, schema habentes trigoni, deformabunt  
normam emendatam.“

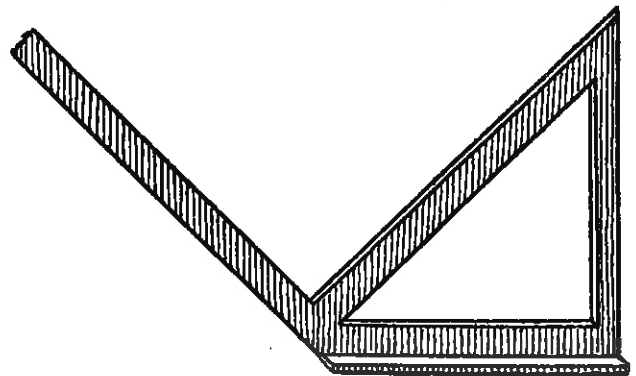

norma ex aere conflata

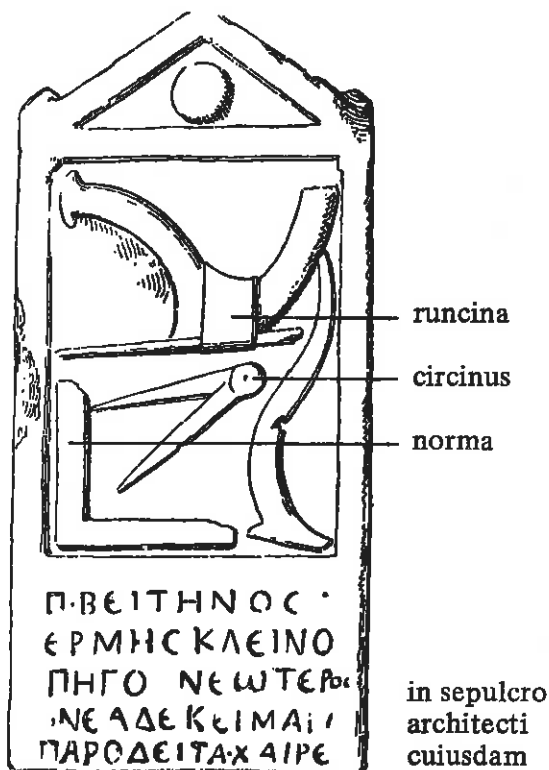

### nota -ae, f.

a) nota significat signum, ut in pecoribus, tabulis, libris, litterae singulae aut binae; apponitur rebus dignoscendi causā; synonyma: *insigne*, *vestigium*, *indicium*.

*Columella*, r. r. 7, 9, 12:

pice liquida notam porcis imponere.

b) speciatim dicitur de signis, quibus formantur litterae.

*Cicero*, *Tusc.* 1, 25, 62:

„qui primus sonos vocis, qui infiniti videbantur, paucis litterarum notis terminavit.“

c) item speciatim de signis, quibus utuntur, qui scribendi compendia celeritatis causā sectantur, unde postea „notarii“ dicti. notas ad compendiarie celeriterque scribendum excogitavit M. Tullius Tiro, libertus Ciceronis et librarius, quas notas Tironias nominant; genus quoddam tachygraphiae usque ad saeculum XIV p. Ch. n. usurpatum.

*Manilius*, *Astronom.* 4, 197 ss.:

„Hic et scriptor erit velox, cui littera verbum est, Quique notis linguam superet, cursimque

loquentis

Excipiat longas nova per compendia voces.“

d) item notae (Thraeciae) dicebantur stigmata, quae inurebantur cuti. Cicero Thracum morem fuisse indicat, ut se notis compingerent. (vide imaginem!)

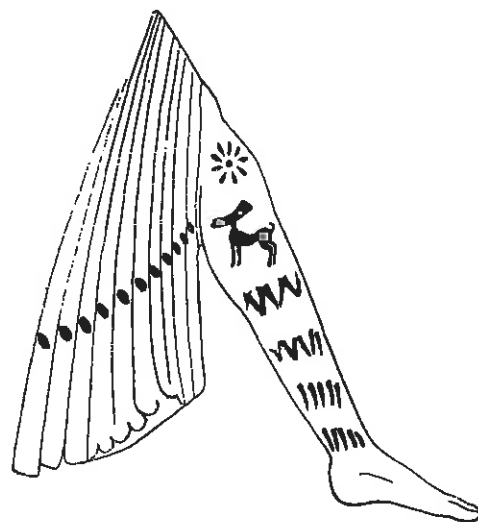

### nundinae -arum, f. pl.

sunt mercatus seu feriae rusticorum, quibus Romam proficiscebantur negotiis domesticis provisuri.

*Macrobius*, 1. *Saturn.* 16, 34:

„Rutilius scribit Romanos instituisse nundinas, ut octo quidem diebus in agris rustici opus facerent, nono autem die, intermisso rure, ad mercatum legesque accipiendas Romam venirent ...“

verbum: nundinor 1, = mercor 1.

### nuptiae -arum, f. pl.

sunt festus matrimonii dies, ritus et hilaritas in uxore ducendā. (*affinitas*)



dextrarum iunctio, ritus nuptialis

formulae dicendi:

virgo nubit viro, vir virginem in matrimonium ducit, (*sponsus*)

nuptum dare: *Nepos*, *Pausan.* 2, 3:

„des ei filiam tuam nuptum.“

*Terentius*, *Phorm.* 752:

„nuptum virginem locavi huic adolescenti.“

**obeliscus** -i, m.

obeliscus est lapis, artificium manu elaboratum et ad rei memoriam erectum, forma *veru* similis. primum obelisci monumenta regum Aegyptiorum fuerant, deinde etiam Romam translata sunt.



**occa** -ae, f.

est instrumentum rusticum ad occandum. occare autem est glaebas infringere, comminuere, in pulverem redigere, ut iacta semina operiri possint. Veget. mul. 1, 56, 5: „crates, quae occa vocatur a vulgo.“

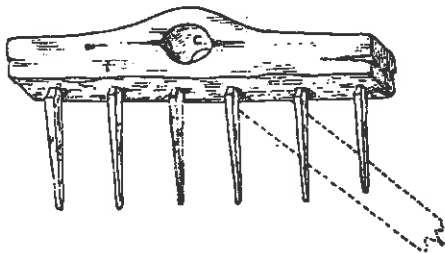

occa

**ocularia**

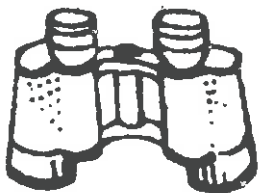

perspicilla specularia



specillum



vitra ocularia (perspicilla)

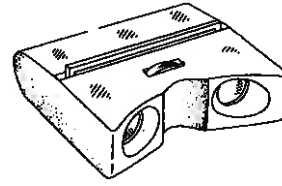

stereoscopium

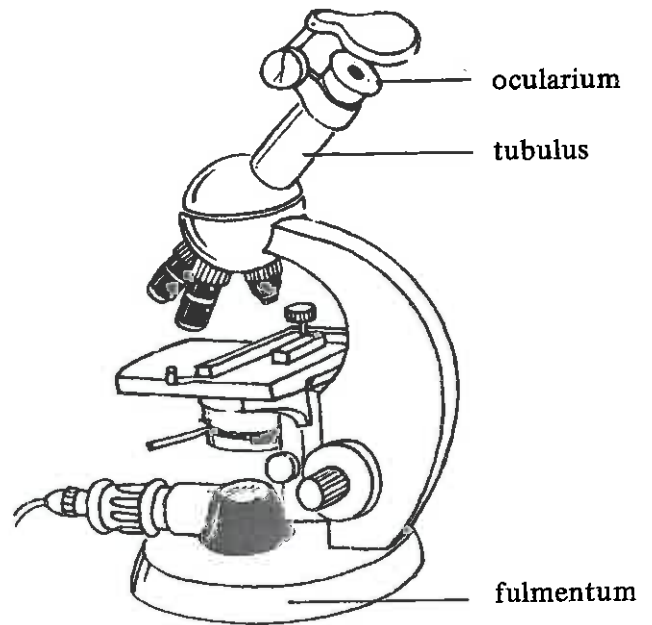

microscopium

**lentes convergentes**

**lentes divergentes**



biconvexa

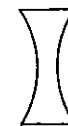

biconcava



plana convexa



plana concava



concava convexa



convexa concava

oculus —i, m.

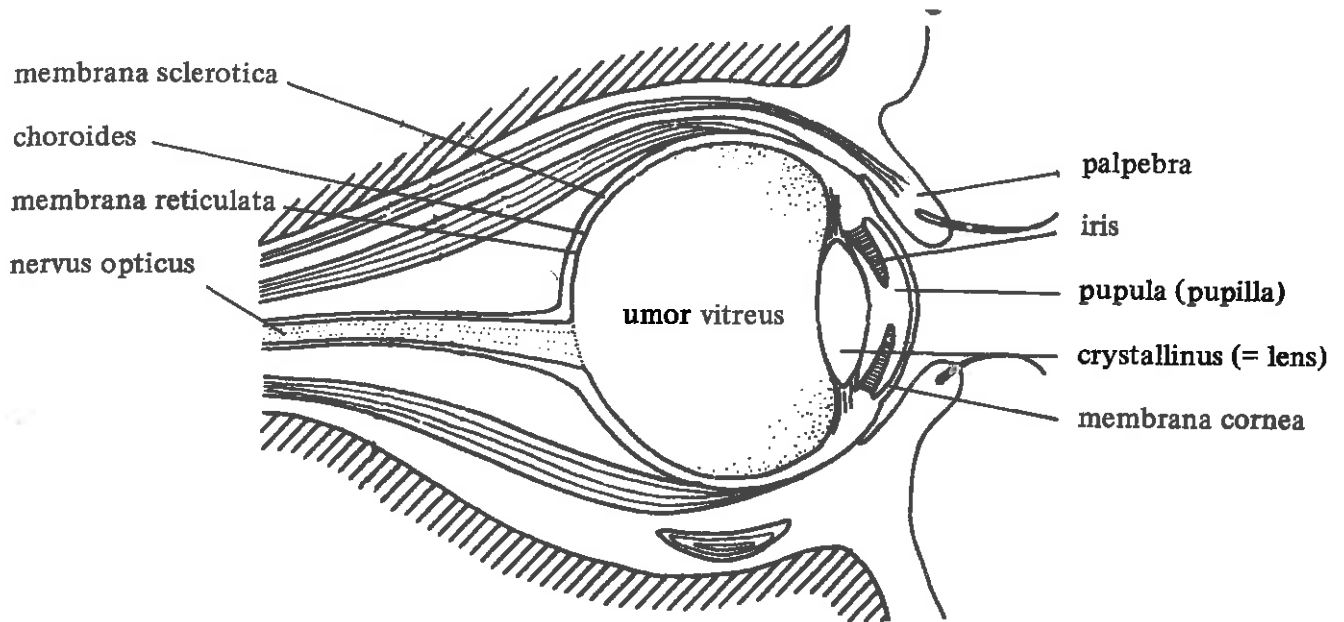

octogonum —i, n.

adi. octogonus, i. e. octo angulos habens, octangulus; Graecum, ex octo et gonia, „angulus“. Vitruvius, 1, 6, 4: turris marmorea octogona.

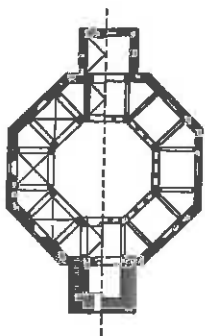

ecclesia Othmarsheim, in Alsatia, formam octogonam (vel circulaem) praebens

ichnographia

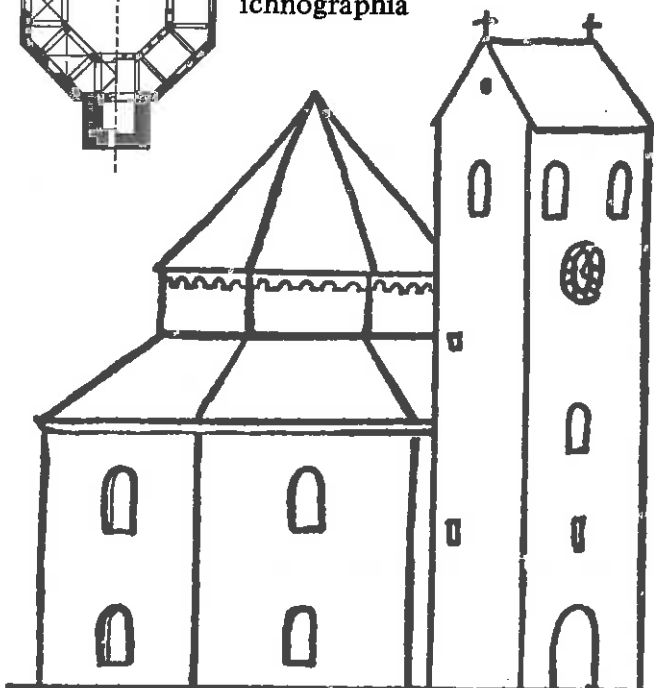

officina —ae, f.

est locus, in quo *artifices* opera faciunt; differt ab apotheca, in qua res conditae asservantur, et a taberna, in qua venales prostant.

Plinius, N. H. 11, 188:

„pulmo spirandi officina, attrahens ac reddens animam.“



fusoris officina (ex opere Olai Magni)

officium —i, n.

est id, quo quis vel quid pro natura sua fungi debet; praestatio eius operis, quod quisque vel quidque praestare debet; quod quisque efficere debet, observata locorum temporum et personarum ratione; congruus actus uniuscuiusque

personae; id in quod quisque debet incumbere, ut ipsum pro loci, temporis et personae qualitate reddat effectum.

Terentius, Eun. 729:

„postquam surrexi, neque pes neque mens satis suum officium facit.“

## oleum —i, n.

oleum est pinguis liquor olivae  
oliva est fructus oleae. constant olivae nucleo (nucleus), oleo, carne, amurcā. olivetum est locus consitus olivis, proverbium: „oleum et operam perdi“ de eo, qui frustra aliquid conatus est; nam oleum lucernae in labore nocturno et operam suam frustrā consumpsit.



in molā oleariā olivae premuntur a duobus geniis ālatis

## olivētum —i, n.

olivetum est locus olivis consitus. (oleum)

Cicero, de re publ. 3, 9, 16:

„nos ... Transalpinas gentes oleam et vitem serere non sinimus, quo pluris sint nostra oliveta nostraeque vineae.“

nomina in —ētum desinentia

significat locum eiusdem generis arboribus consitum, ut vinētum, fruticētum, pinētum, quercētum, harundinētum, pomētum (pomarium) cupressētum, murtētum.

Varro, r. r. 1, 55, 1s:

„de oliveto oleam, quam manu tangere possis e terrā ac scalis (scala) legere oportet potius quam quaterre ... quae manu stricta, melior ea quae digitis nudis, quam illa quae cum digitabulis (digitabulum) ... quae manu tangi non poterunt, ita quati debent, ut harundine (harundo) potius quam perficā feriantur.“

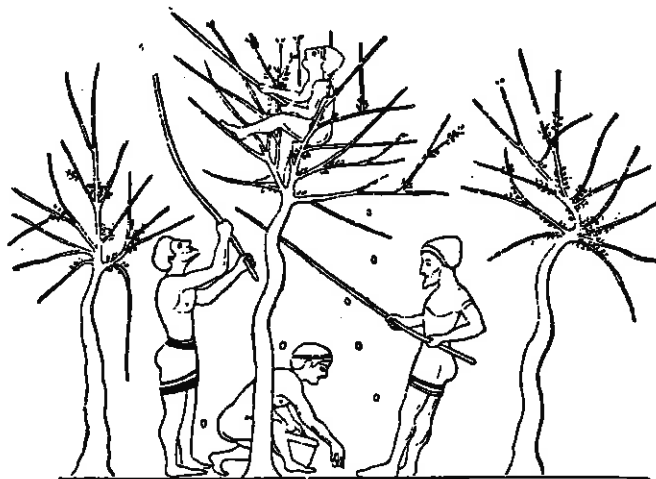

agricolae harundinibus vel perficis olivas decutiunt

## opus —eris, n.

est id quod fit operando; differt ab operā, quae est actio, qua fit opus.

opus alexandrinum

est opus tessellatum eius generis, quod Alexandriae factum est.

opus incertum, incerta caementa alia super alia sedentia inter seque implicata, non speciosam, sed firmiorem quam reticulata praestant structuram.

opus reticulatum

reticulata structura parietum est, cum lapidei cunei sibi invicem superpositi et in latera iacentes ita parietem convestiunt, ut eorum capita foris exstantia, retis (rete) figuram referant.

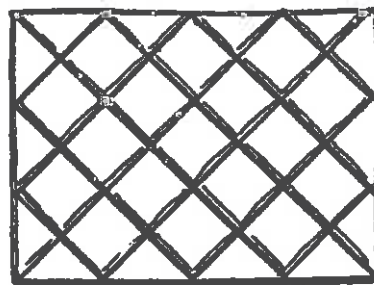

opus spicatum

est pavimentum aut structura parietum ex laterculis seu testis (testa) in modum spicae (spica) dispositis.

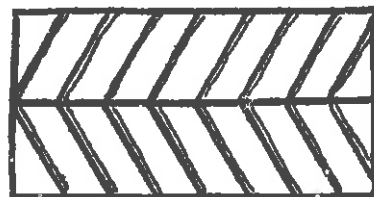

opus tessellatum est pavimentum parvis lapillis (tessellis) compositum.



## oraculum —i, n.

est deorum responsum.

Seneca, Contr. 1, praef., 9:

„Quid est enim oraculum? nempe voluntas divina hominis ore enuntiata.“

Socrates omnium sapientissimus oraculo Apollinis iudicatus est.



in imagine vasis Graeci picti Pythia (nomine Themis) in tripode (*tripus*) sedet, manu sinistra pateram, manu dextra ramum lauri tenens, responsum (= oraculum) Apollinis effatur Aegaeo regi Atheniensium

## orbiculus —i, m.

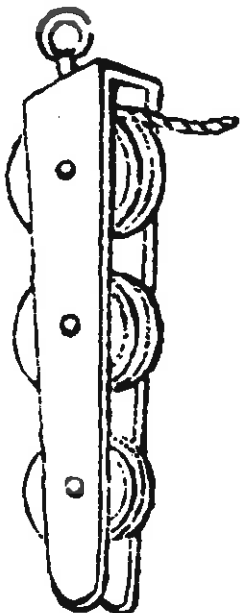

313

a) est parvus orbis, circulus, rotula.

b) genus machinae, quae Graece polyspaston appellatur, quod multis orbiculorum circuituibus et facilitatem summam praestat et celeritatem ad attollenda onera gravia.

## orbis terrarum

est circulus earum terrarum vel regionum, quae Mare Nostrum (vel Mare Internum, vel Mare Mediterraneum) circumdant et universae Oceani circulo cinguntur. talem Homerus in Achillis clipeo (*clipeus*) universam terram repraesentat.

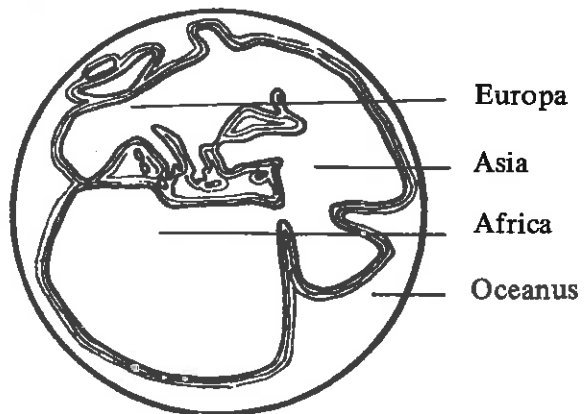

Orbis terrarum Medii Aevi

314

## Orestes –is, m.

Orestes, filius Agamemnonis et Clytaemnestrae, occisis Aegistho et Clytaemnestrā a Furiis per omnes terras orbis (*orbis terrarum*) agitated, expiandae necis causā Delphos (*Delphi*) pervenit ut ab Apolline crimine liberaretur (expiatio –onis, f.)



imago Oresten ante deum Apollinem in umbilico (*umbilicus*) taeniis ornato sedentem demonstrat. Apollo dextrā ramum lauri tenet, sinistrā citharam (*instrumenta musica*). in dextro latere imaginis Pythia in tripode (*tripus*) sedet, infulam (*infula*) sacerdotis manibus portendens. ante eam Pylades, amicus fidissimus Orestis, vaticinium (*vates*) exspectat

## ornatrix –icis, f.

ornatrix erat ancilla, quae dominae crinem componebat.



ancilla dominae crinem componens. in abaco (*abacus*) scrinium, fasciae, sub abaco vas cum unguento.

## os oris, n.

os est interior pars faciei, apta ad edendum, spirandum et loquendum. consonantes, quae in labiis formantur, labiales,

quae in dentibus dentales, quae in palato palatales, quae in velo velares, quae in gutturo gutturales nuncupantur.

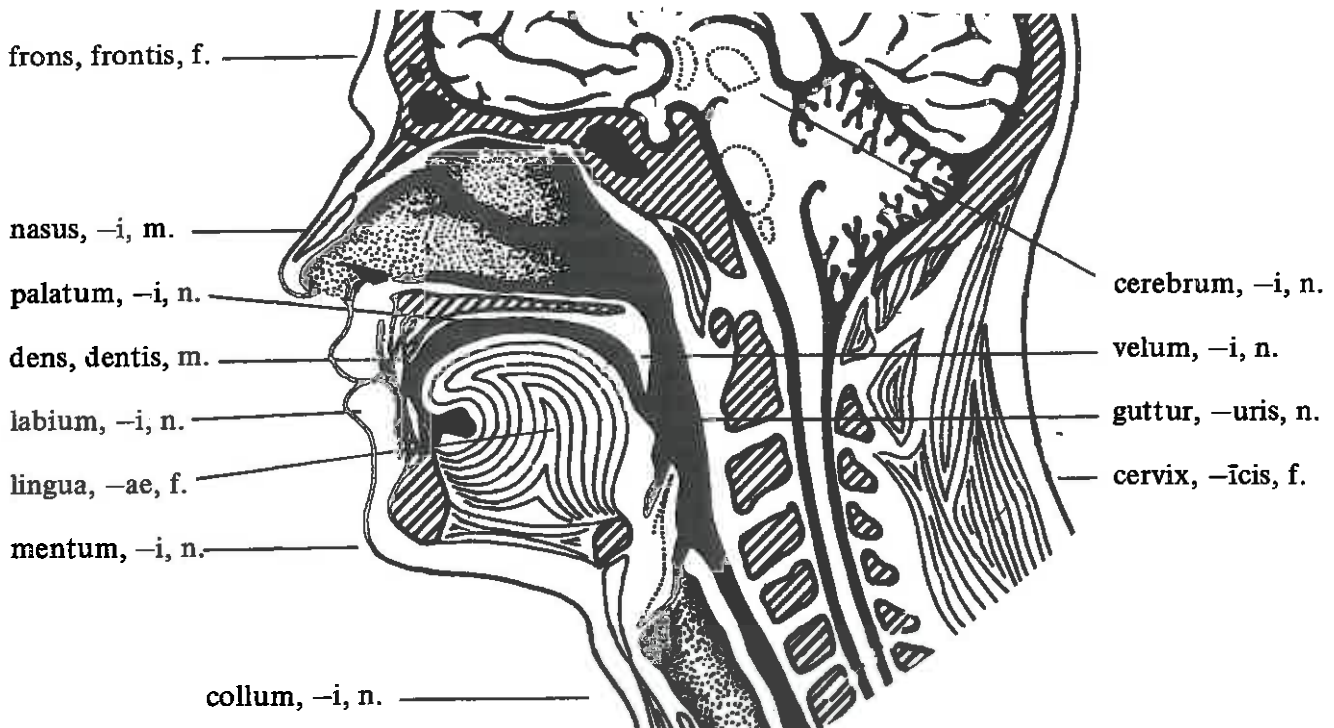

**OS OSSIS, n.**

ossa capitis sunt calvaria (1), et duae maxillae (2) cum dentibus; spina dorsii (3), quae constat 34 vertebrae (4), costae (5), duae scapulae (6), os sessibuli (7), lacertus (8), tibia (9), fibula (10) anterior et posterior (11). in ossibus est medulla.

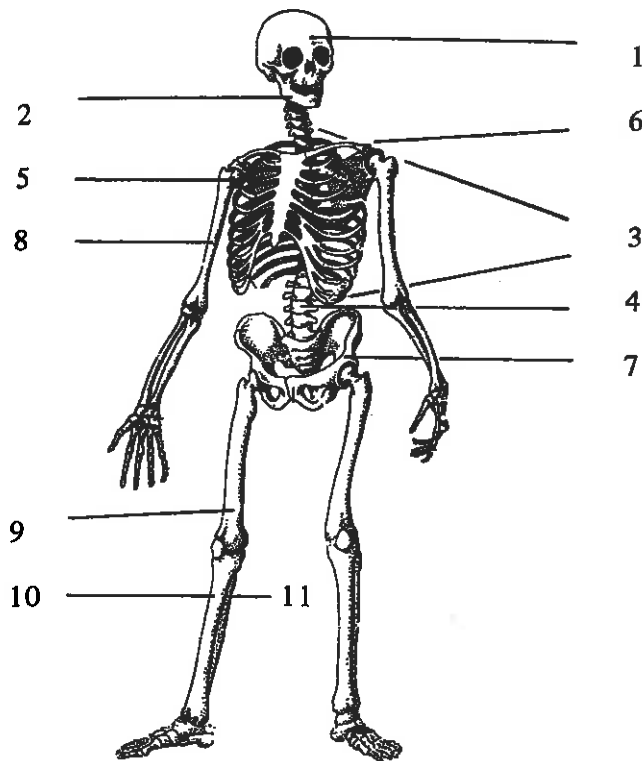

ossa hominis

**oscillatio -onis, f.**

est iactatio per funem (funis); ritus et ludi genus.



oscillatio

oscilla sunt parvae imagunculae, seu parvae *statae*, quae arte fictili fingebantur et quas arboribus appendebant ut campi a deo, cuius imaginem portabant, protegerentur.

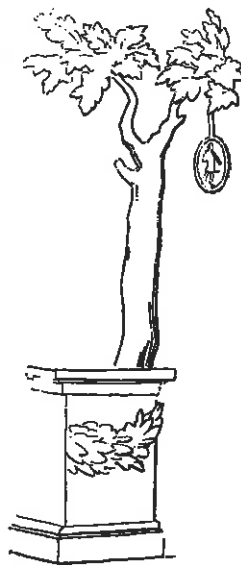

oscillum in arbore sacra prope aram (*ara*)

**ovum -i, n.**

ovum est fetus avium, piscium et quorundam animalium terrestrium, unde pulli fovendo excluduntur. ovi partes sunt vitellus, seu luteum ovi, et albumen seu album, quod putamine, seu cortice continetur.

dictum: „ab ovo usque ad mala“ narrare aliquid, i. e. ab initio usque ad finem narrare, nam convivis primum ova apponi solebant, in secunda mensa varia genera mälorum.

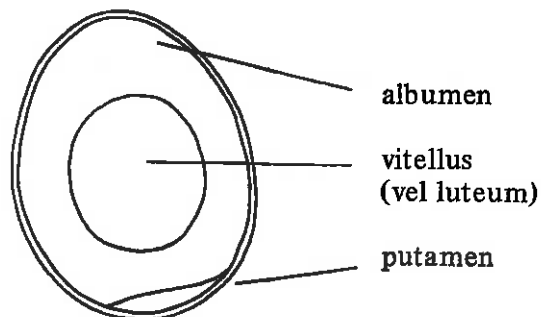

**paeninsula** —ae, f.

est terra undique fere aquis clausa, una tantum parte, eaque angusta, continenti adhaerens: a „paene“ et „insula“, quia quasi insula est. promonturium paeninsula est abrupta et saxosa.

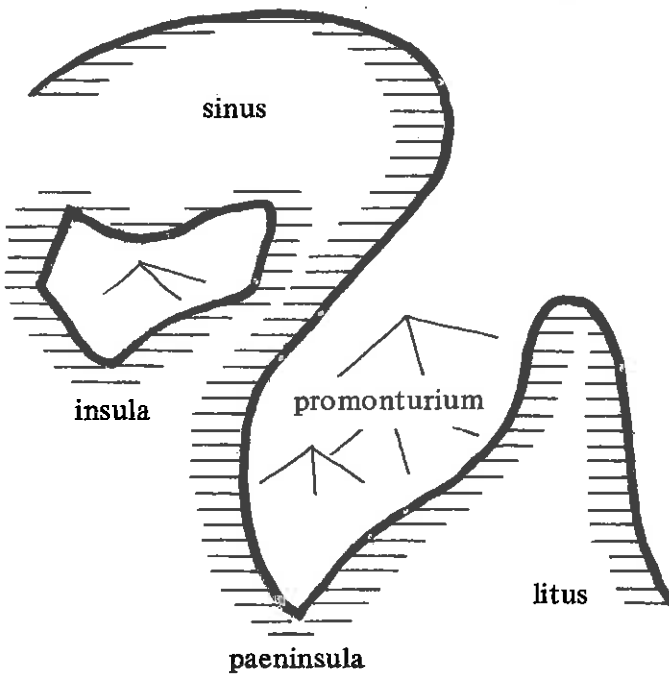

**pagus** —i, m.

pagus sunt plures vici aut villae simul positae, nullo moenium ambitu.

speciatim Germaniae et Galliae populi eorumque regio in pagos dividebatur, qui erant pars ampla regionis.

adi. paganus, ad pagum pertinens.

\*\*apud ecclesiasticos scriptores paganus est, qui gentilium superstitionem retinet et falsos deos colit, quia cum Christiana religio passim vigere coepit in urbibus, in solis pagis et villis illa servabatur.

**pala** —ae, f.

est instrumentum ferreum, rusticum, ligoni (*ligo*) simile, sed planum et latius, quo terra versatur, egeritur, vel aggeritur.

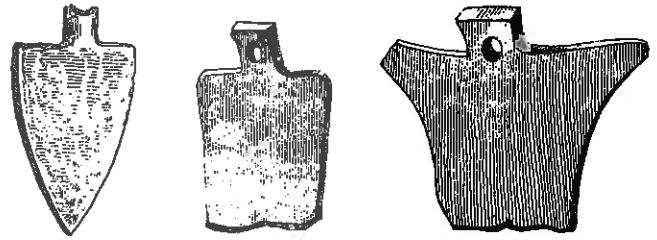

**palatium** —i, n.

a) mons Palatinus, unus ex septem collibus (*collis*) urbis Romae (*septimontium*), in quo urbs pri-

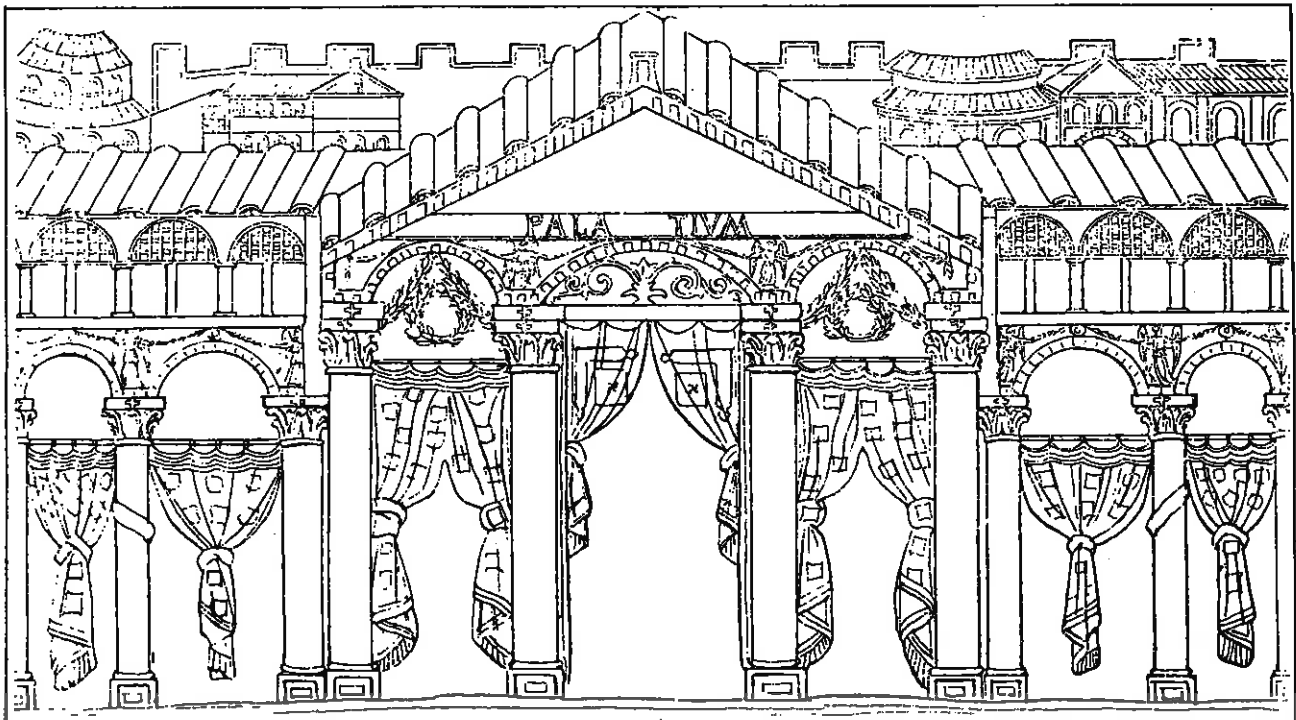

palatium Theodosii Ravennae situm

mum condita est. haec regio urbis Palatium nominabatur.

b) sub imperatoribus ibi aedes maximae immensis sumptibus exstructae sunt: unde factum est, ut domus principis palatium vocaretur.

### palimpsestus -i, m.

est membrana iterum abstersa *spongiā*, ut in ea scribi pluries possit.

Cicero, ad familiares, 7, 18, 2:

„nam quod in palimpsesto (sc. scripsisti), laudo equidem parsimoniam, sed miror, quid in illa chartula fuerit, quod delere malueris, nisi forte tuas formulas.“

codex palimpsestus = codex rescriptus. (a verbo graeco palin psao = iterum abraderere.)



### pallium -i, n.



pallium est quicquid cooperiendo corpori inservit; speciatim pallium est vestis longa, fusa et ampla, quae tunicae induitur: propria est Graecorum, tum virorum, tum mulierum, sicut toga Romanorum et Itolorum.

adi. palliatus = pallio amictus: et fere apud Latinos de Graecis dicebatur. fabulae palliatae sunt quae Graecos mores, Graecosque homines inducunt; contra togatae, quae Romanos Italosve.

### paludamentum -i, n.

dicitur de veste militari imperatorum et ductorum exercitū: sagum enim in universum appellabatur vestis militaris, sed imperatoris proprium erat paludamentum.



### palus -udis, f.

palus est aqua stagnans, quae aestate plerumque siccatur; in quo differt a lacu, qui perpetuam habet aquam.

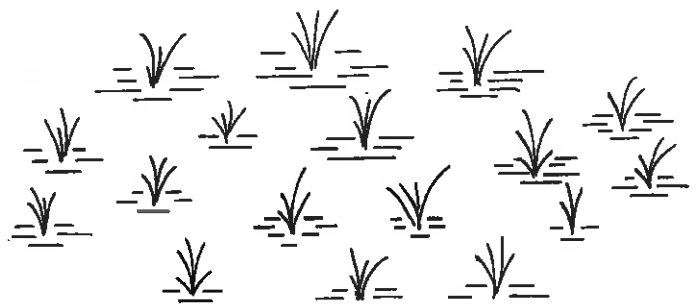

pānis —is, m.

panis est cibus ex farinā et aquā igne coctus.

Seneca, ep. 90, 23:

„tunc farinam aquā sparsit et assiduā tractatione

perdomuit, finxitque panem, quem primo cinis calidus et fervens *testa* percoxit: deinde *furni* paulatim reperti.“

Plautus, Asin. 200:

„a pistore panem petimus, vinum ex oenopolio.“  
*pistor* qui praecipue panes conficit, *pānificus* vocatur, officina eius est panificium.

Schol. ad Iuvenal, 8, 159:

„unguentarii et panifici, id est pistori et coci.“



taberna pistoris

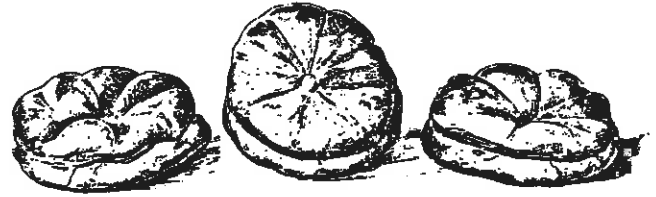

pānes Pompeiis inventi

*fermentum* est intritum ex farinā aquā subuctā et maceratā sine sale, donec acescat; a „fervendo“, quia *massam* ad panificium subactam, cui inicitur, quasi fervefacit et attollit turgidamque reddit. *formula dicendi*: panis sine fermento, de re insipidā.

## Pannonia, Dalmatia, Moesia, Dacia, Thracia



## Pantheon Romanum

vulgo Rotundum nominatur, ab Agrippa seu constructum seu instauratum; porticu (*porticus*) sedecim columnarum (*columna*) Corinthiarum ornatum est, unicum templum Romanum quod adhuc hodie integrum conspicitur. Lux in eo superne per magnum *foramen* in fornix (*fornix*) medio constructum intrat. in interiore templi circuitu septem magnae *apsides* (*apsis*) sunt, totidem deorum (fortasse Planetarum) statuis collocandis destinatae. fornix totius templi inaurato aere opertus fuit, quod aes olim ab imperatore Constantio II sublatum est. trabes aeneae porticus a papa Urbano VIII sublatae sunt, ut baldachinum ecclesiae Sancti Petri et tormenta bellica in arce (*arx*) Sancti Angeli collocanda funderet. De quo papa scripsit poeta quidam: „quod non fecerunt barbari, fecerunt Barberini“ nam Urbanus VIII e gente Barberini oriundus erat.

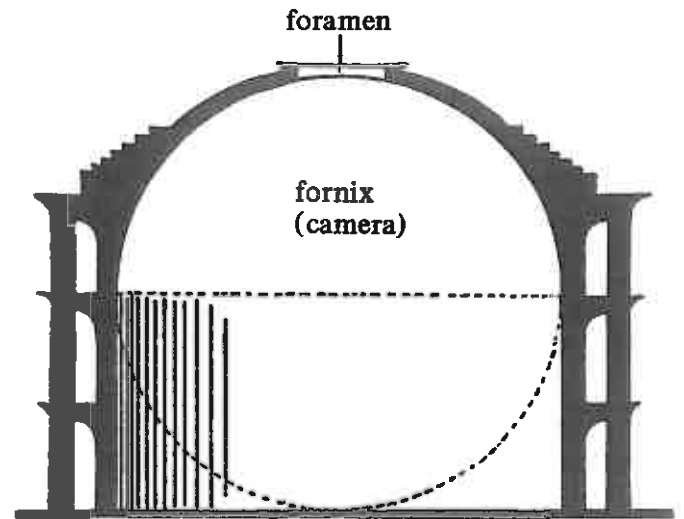

orthographia Pantheonis

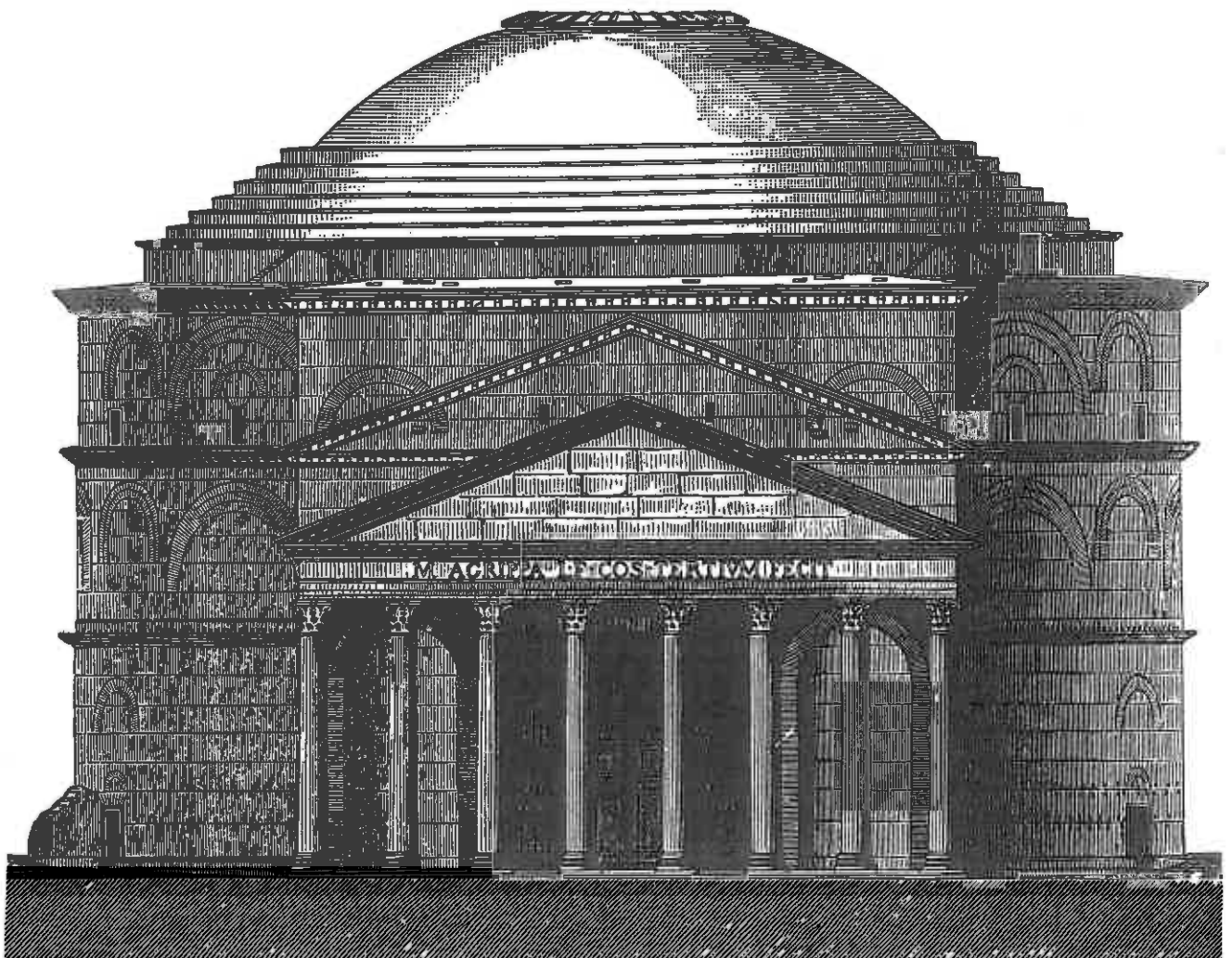

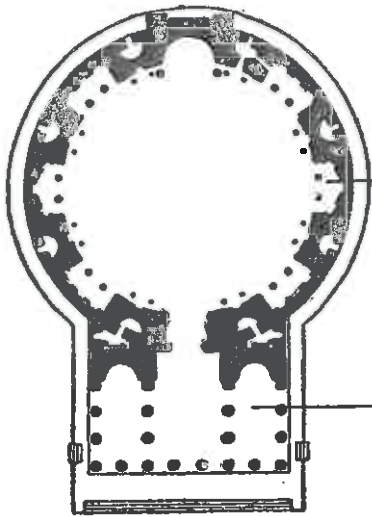
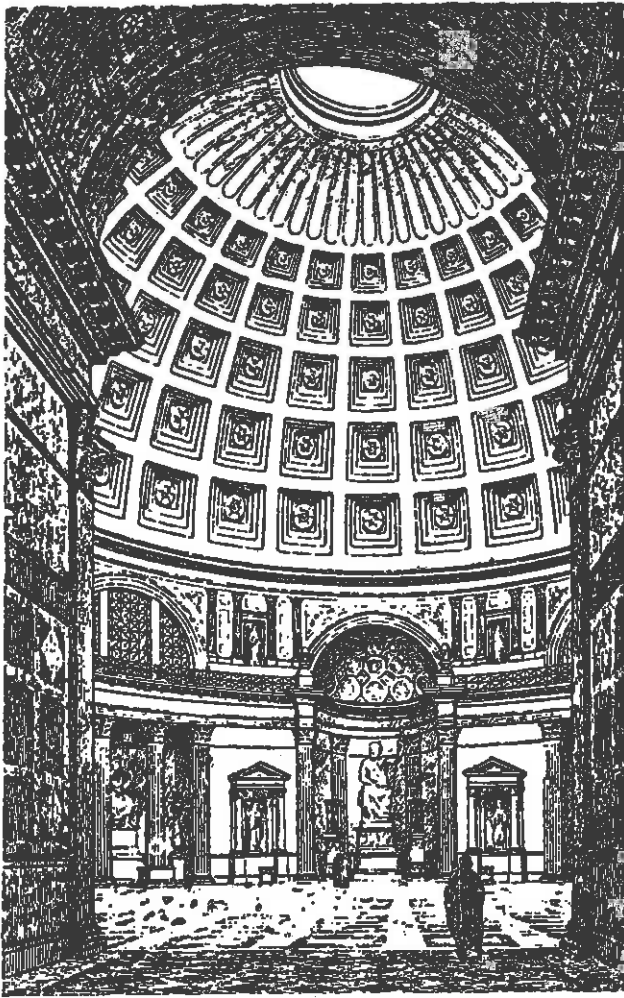

apsis

porticus

ichnographia  
Pantheonis

papilio -onis, m.

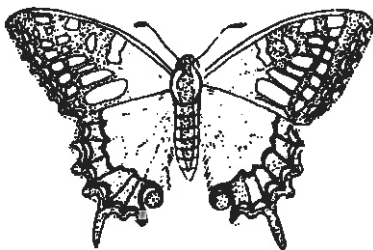

327

a) est insectum alatum luminibus accensis advo-  
litans, ignavum et inhonoratum, apibus inimi-  
cum, cerasque earum depascens, et excrementa  
relinquens quibus teredines gignuntur: fila  
(*filum*) etiam araneosa (*aranea*), quacumque  
incessit, alarum maxime lanugine obtexens.  
b) translate est militare tentorium, quia expan-  
sa vela habet ad similitudinem alarum papilionum.

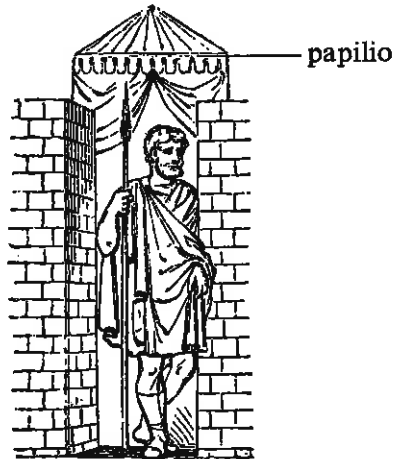

papyrus -i, m. vel f.

Plinius, H. N. 13, 71:

„papyrus nascitur in palustribus Aegypti, aut  
quiescentibus Nili aquis, ubi evagatae stagnant,  
duo cubita non excedente altitudine gurgitum  
(*gurges*), brachiali radice obliquae crassitudine,  
trianguli lateribus, decem non amplius cubi-  
torum longitudine in gracilitatem fastigatam,  
thyrsi (*thyrsus*) modo cacumen includens,



328



nullo semine, aut usu eius alio, quam floris, ad deos coronandos.“

e libro (*liber*) interiore papyri praeparantur chartae. texuntur plagulae libri et conglutinantur suco papyri, prelis (*prelum*) premuntur et sole siccantur.

### Parcae —arum, f. pl.



tres sorores, filiae Noctis erant, quarum prima Clotho, secunda Lachesis, tertia Atropos nominari solent. filium illae vitae humanae nere, semperque pensa sua trahentes finem quoque vivendi cuique hominum definire dicuntur. Clotho nomen a verbo Graeco „klotho“ = neo derivat, Lachesis cuius appellatio a „langchanein“ = sortiri, originem trahit, tertia Atropos ideo dicitur, quod immutabilis sit („trepo“ = verto). in opere caelato Clotho fusum (1) tenet et filium net, Lachesis filium forcibus (2) secat, Atropos fatum globo mundi (3) declarat.

### paries —etis, m.

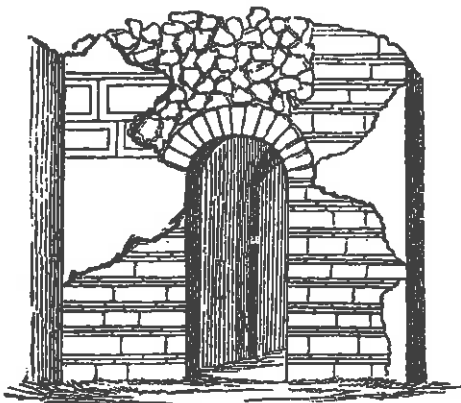

paries est murus domum aliudve privatum aedificium ambiens et sustinens; differt a muro, nam hic est fere publicus et urbem cingens.

paries craticius est *crates* e viminibus facta lutoque intecta.

paries latericius est lateribus (*later*) structus, ut in imagine videtur.

„intra parietes“ est domi, privatim.

proverbium: „in caducum parietem inclinare“, dicitur de eo, qui nititur rei parum firmae.

„duos parietes de eadem fidelia dealbare“, de eo, qui apud omnes, etiam adversos inter se, gratiam inire quaerit.

Horatius, ep. 1, 18, 84:

„nam tua res agitur, paries cum proximus ardet.“

### patagiū —ii, n.

est id, quod ornatūs causā in muliebri veste circa collum, seu super scapulas addebatur, ut clavus in virili.



## patēna —ae, f.

patena (aut patina) est vasis genus, quo utebantur ad condiendos et coquendos pisces et alia.

Phaedrus, 1, 26 ss.:

„Vulpes ad cenam dicitur ciconiam prior invitasse, et illi patinā liquidum posuisse sorbitionem ...“



## patēra —ae, f.

est poculi genus planum ac patens, cuius usus in sacris plurimus.

Varro, L. L. 5, 122:

„(pateris) etiam nunc in publico convivio, antiquitatis retinendae causā, cum magistri fiunt, potio circumfertur; et in sacrificando deis hoc poculo magistratus dat deo vinum.“

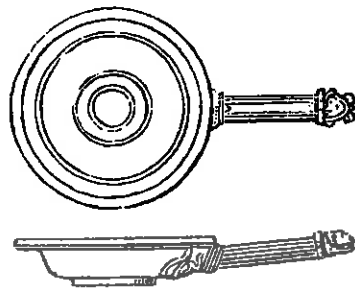
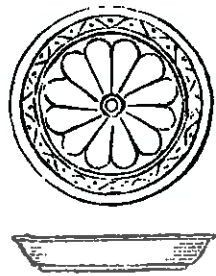

## pavimentum —i, n.

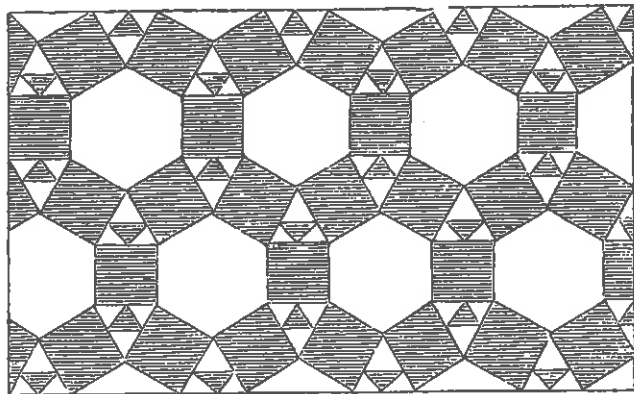

est domus solidamentum, sive incrustatio, quam gradiendo inculcamus (*domus Romana*).

Cato, r. r. 18, 7:

„ibi de *testa arida* pavimentum struito, ubi structum erit, pavito, fricatioque oleo, uti pavementum bonum siet.“

a verbo „pavio (—īvi, —itum, —īre)“ = caedere, tundere, pulsare. formula dicendi: terram aut solum pavire = tundendo calcandoque solidare.

## pecten —inis, m.

pecten est instrumentum comatorium densis dentibus instructum ad capillos explicandos.

Plautus, Captivi 268/69:

„... utrum strictimne attonsurum dicam esse an per pectinem,

nescio ...“

h. e. longius a cute, pectine interposito.

verbum: pecto, pexi, pexum, pectere = componere et ornare capillos pectine.

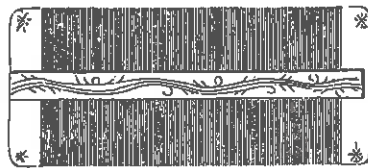
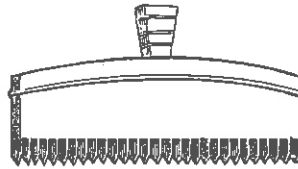

pecten  
„denso dente“

## pavo —onis, m.

est avis vario pennarum fulgore conspicua, quam poetae Iunoni tutelae assignarunt, cuius illa caudam ornasse fingitur oculis Argi a Mercurio interempti.

mos fuit flabella (*flabellum*) ex caudis pavonum facere ad abigendas muscas.

\*\*in operibus artis Christianae pavo est *symbolum* vitae aeternae.



\*\*\*pediludium -i, n.

est lusus pilae, quo pila pedibus impellitur aut capite, numquam manibus aut corpore. haec est collocatio lusorum:

Prima collocatio, ubi sunt quaterni et terni et terni:

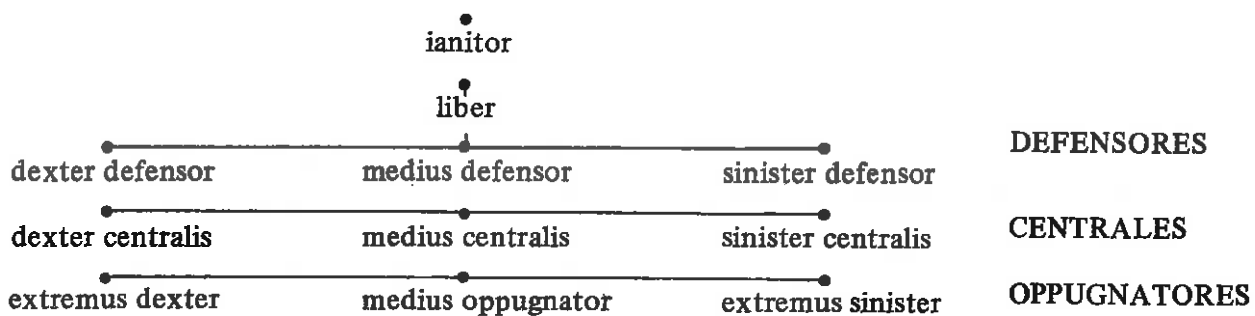

Altera collocatio, ubi sunt quaterni et quaterni et bini:

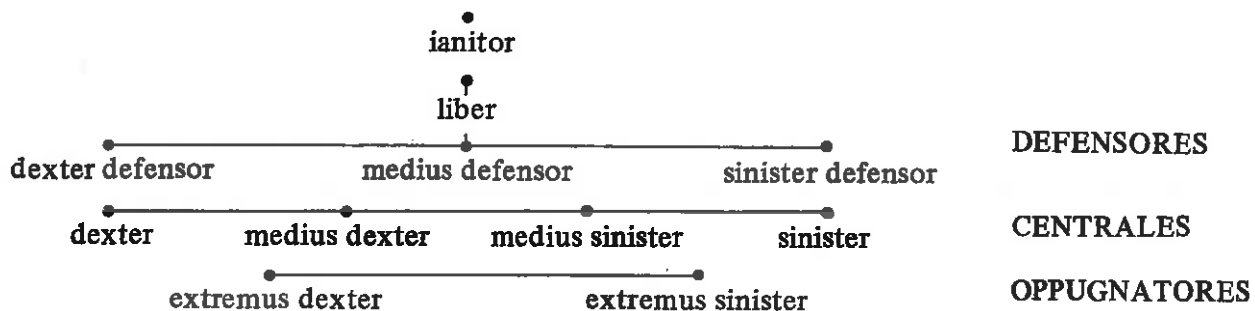

**penna** –ae, f.

pennis anserinis vel gallinaceis utebantur prius ad scribendum. sumenda erat penna caule amplā, nitida et firma. Hoc modo aptanda erat penna, ut nobis explicat Ludovicus Vives in colloquio suo „de descriptione“: „detrahite plumulas scalpello et detruncate aliquid a caudā, tum eradite, si quam habent scabritiem; nam levigatae fiunt aptiores ... primum omnium rescindetis caput, ut fiat bifurcata. tum in superiore parte incisuram facite scalpello sensim ducto, quae **crena** vocatur. hinc aequate duos illos pedunculos ... ita tamen, ut altior sit dexter, in quem penna scribendo incumbit: id tamen discrimen vix perceptibile oportet esse.“ (*instrumenta scribendi*)

scalpulum

crena



Notker Balbulus in scriptorio pennam aptans

**pergula** –ae, f.

pergula est locus extra parietem (*paries*) porrectus, saepe tectus vineis aliisque plantis, ubi in umbra deambulatur. (italiane: pergola)

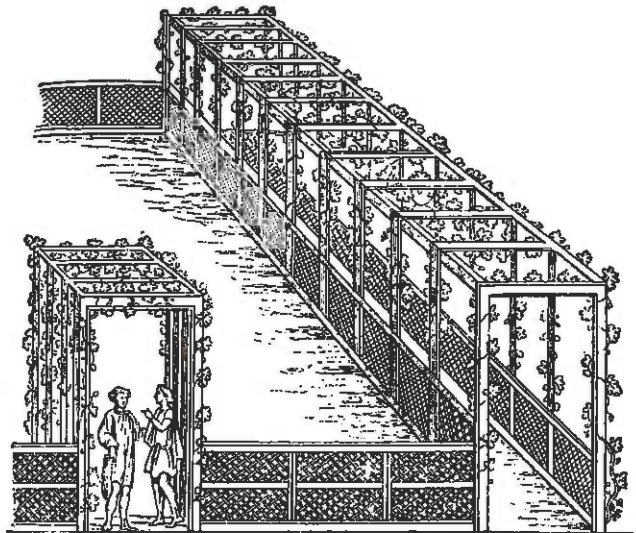

picturae murales Romanae pergulas exhibentes

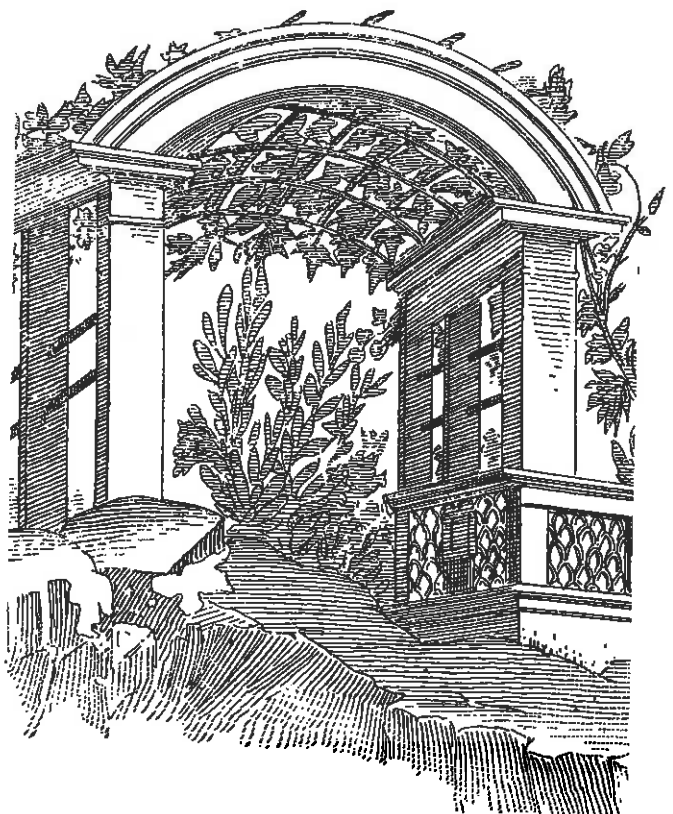

## perpendicularum —i, n.

est instrumentum fabri materiarii seu caementarii, quo plumbo a filo pendente rectitudo aut obliquitas operis perpenditur et examinatur. eius inventor fuit Daedalus.

Plinius, H. N. 36, 172:

„structuram ad normam (*norma*) et libellam (*libella*) fieri, ad perpendicularum respondere oportet.“

Vitruvius, 6, 8, 5:

„uti omnes structurae perpendicularo respondeant, neque habeant in ulla parte proclinationes.“



perpendicularum

## persona —ae, f.

a) est larva histrionalis, h. e. ficticia facies, qua fabularum actores utebantur, totum caput obtegens, aversā parte capillamento instructa, adversā humanum vultum senis aut adolescentis aut mulieris etc. referens, ore tamen iusto latiore et rotundo, qua vox exiret facilius.



tragoediae personae



comoediae personae

b) latiore sensu a similitudine dicuntur personae simulacra et imagines (*imago*), hominum aut animalium capita vultusque ferentes.

c) translate persona dicitur ipse actor et histrion. hinc in fronte fabularum Plauti et Terentii enumerantur personae, quae in iis inducuntur loquentes.

d) persona est conditio, status, munus, quod quisque inter homines et in vita civili gerit.

Cicero, Quinct. 13. 45:

„petitoris personam capere, accusatoris deponere.“

e) persona pro homine absolute usurpatur:

Paulus, Dig. 1, 5, 1:

„omne ius, quo utimur, vel ad personas pertinet, vel ad res, vel ad actiones.“



meretricis persona



senis persona



personatus,  
personam senis  
gerens.  
personatus est  
is, qui personā,  
larvā indutus  
est.

### pharmacopola —ae, m.

facit et vendit remedia et unguenta omne genus.



in opere caelato sarcophagi delineatum est  
pharmacopolium variis vasis et instrumentis  
instructum, in sinistra parte est *mortarium*  
cum *pistillum* (*pistillum*)

### pharus —i, f.

a) Pharos erat oppidum Aegypti apud Alexan-  
driam; in ea ingens *turris* erat, ex qua lumen per  
noctem navigantibus elucebat.

b) hinc etiam machinae in portibus (*portus*)  
idem officium navigantibus praebentes, phari  
nominabantur.

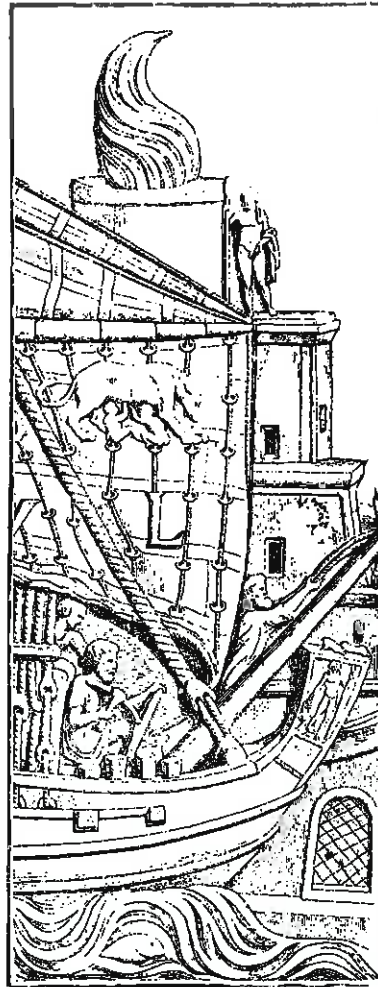

imago nostra pharum portūs Ostiensis monstrat,  
simulque navem e portu altum mare petituram.  
(in velo navis depicta est lupa Romulum Re-  
mumque lactans.)

opus caelatum e collectione Torlonia

### phaselus —i, m.

a) proprie est genus leguminis, quod quidam in  
duo genera dividunt, maius et minus. (in re bota-  
nica: phaseolus vulgaris et vicia faba)



b) transláté est navigii genus, mixtam formam habens ex oneraria et longa triremi, quod tam velis quam remis agi poterat; brevis est navicula, qua naves maiores in alto mari versantes conscendebantur.

ficiles etiam phaselos in usu fuisse apud Aegyptios testatur Iuvenalis, 15, 127:

„parvula fictilibus solitum dare vela phaselis.“  
 phaselus est „navium celerrimus,“ Catullus 4, 2. .

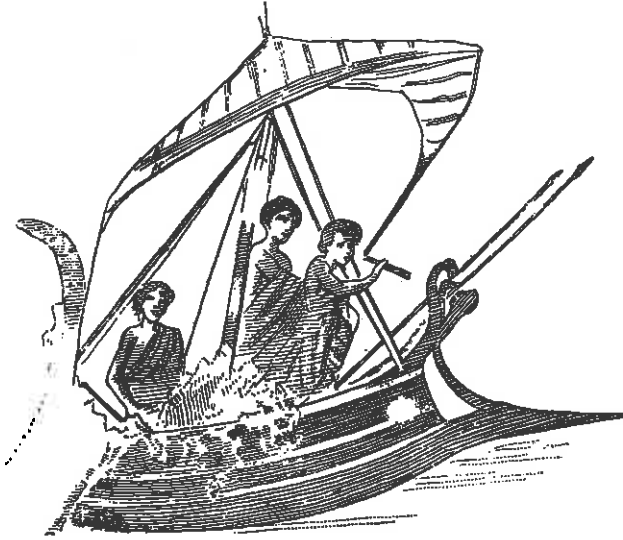

### Phoenix —icis, m.

est avis in Arabiã nobilis, auri fulgore circa colla, cetera purpureus, caeruleam roseis caudam pennis distinguentibus. senescens se ipse odoribus et igni cremat iterum resurrecturus e cineribus.



Phoenix, signum Blondini, impressoris Florentini, saeculi XVI.

### Phrixus et Helle

Phrixus, cum ab Ino noverca ad necem quaeretur, una cum Helle sorore profugit, raptu ariete velleris aurei (*vellus aureum*), in quem conscendentes mare transmittebant. sed ad fretum Aegaei Helle exterrita decidit mersaque est Hellespontoque nomen dedit. Phrixus vero incolumis in Colchidem pervenit ad regem Aecten, ubi, Iovi ariete mactato, aureum vellus Marti sacravit; quod, a dracone custoditum, Iason cum Argonautis ope Medeae inde abstulit. aries autem intra sidera translatus est. (*Argo*)



pictor —oris, m.



imago officinam pictoris monstrat: 1 machina pictoris 2 discus colorum 3 peniculus vel penicillus 4 sella 5 exemplar, simulacrum

nomen agentis, derivatum a verbo pingere (pinxi, pictum). actio pictoris est pictura, i. e. actionum statuumque imitatio colorum linearumque ope perfecta.

### pictura —ae, f.

pictura est ars pingendi; metonymice sumitur pro tabula, vel tela, vel alia re picta.

Cicero, Verr. 4, 1, 1:

„nego ullam picturam neque in tabula, neque textilem fuisse, quin conquisierit (sc. Verres), inspexerit, quod placitum sit, abstulerit.“

hae picturae distinguuntur:

a) pictura in tabula (sc. lignea),

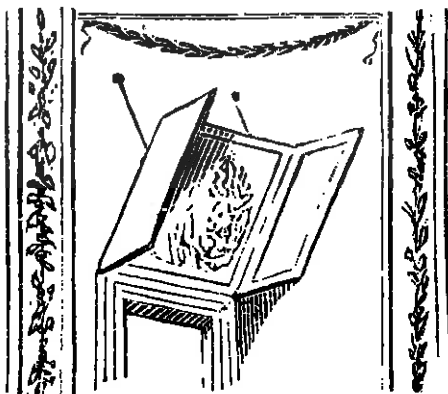

pictura  
in tabula

b) pictura in linteo vel in sipario,



pictura  
in linteo

- c) pictura inusta,
- d) pictura udo tectorio (*tectorium*),
- e) pictura textilis, vel imago acu (*acus*) picta.

### picus —i, m.

avis est quae tundit et cavat arborum cortices (cortex) et sic insecta venatur.



### pila —ae, f.

pila est sphaera, globus, quo luditur.

Petronius, Satyr. 27:

pilam repetere, quae terram contigit.

Plautus, Captivi, 22:

„enimvero dii nos quasi pilas homines habent.“





pīla —ae, f.

a) pila est *mortarium*, vas aeneum, lapideum aut ligneum, in quo aliquid pinsitur et comminuitur.

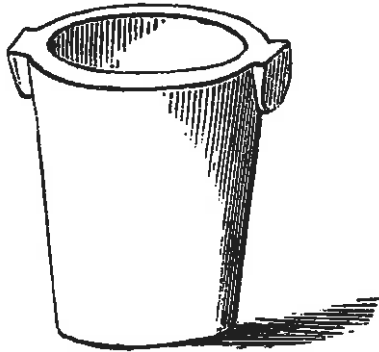

b) pila est structura erecta in modum columnae, ad aliquid fulciendum. differt a *columna*, quae uno *scapo* constat, h. e. lapide oblongo perpetuo: pila vero structilis est pluribus lapidibus aut lateribus.

*Livius*, 40, 51, 4:

„locavit pilas pontis in Tiberim: quibus pilis fornices (*fornix*) post aliquot annos ... locaverunt imponendos.“

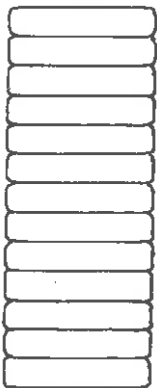

c) pila item est saxea moles, quae praestruitur litori ad frangendam undarum vim.

d) \*\*\*pila electrica

pilae elementum:

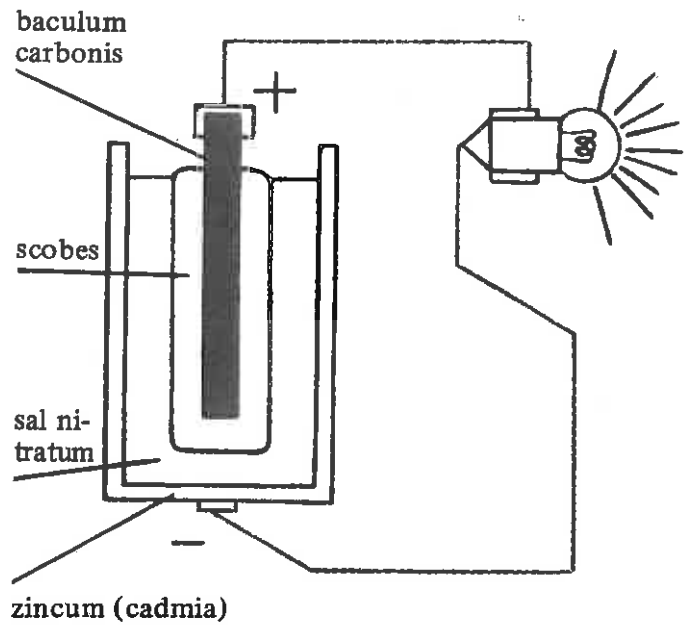

piliarius —ii, m.

vir est e genere circulatorum (*circulator*), qui uno tempore complures pilas in aërem iactat easque manibus et pedibus agilibus captat.

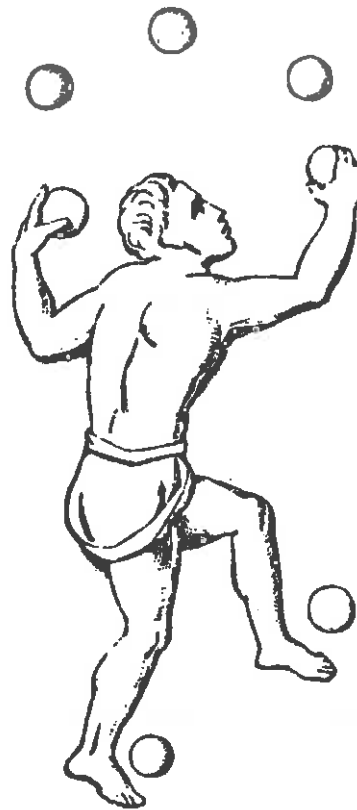

**pileus** -i, m. (vel -eum n.)

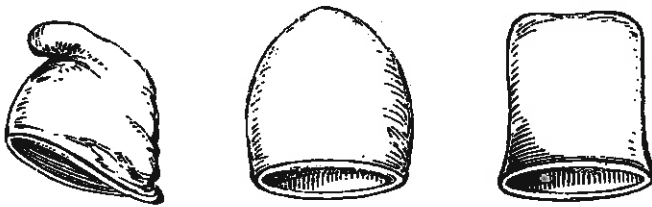

est tegmen et indumentum virile capitis, pilei figura fere similis erat dimidio ovi (*ovum*) putamini.

Paulus Diaconus, p. 207, 4 M.:

„pilea *Castori et Polluci* dederunt antiqui, quia Lacones fuerunt, quibus pileatis pugnare mos fuit.“ (*manumissio*)



pileolus

**pinna** -ae, f.

a) est id, quo aves vestiuntur; differt a pluma, quae tenuior est, mollior et densior, totumque corpus tegit.

b) murorum et turrium et valli cacumina, quae in acutum per intervalla desinunt, pinnae vocantur.

Caesar, B. G. 7, 72, 4:

„aggerem et vallum ... exstruxit, huic lorica pinnaeque adiecit.“

**pinnae moenium**

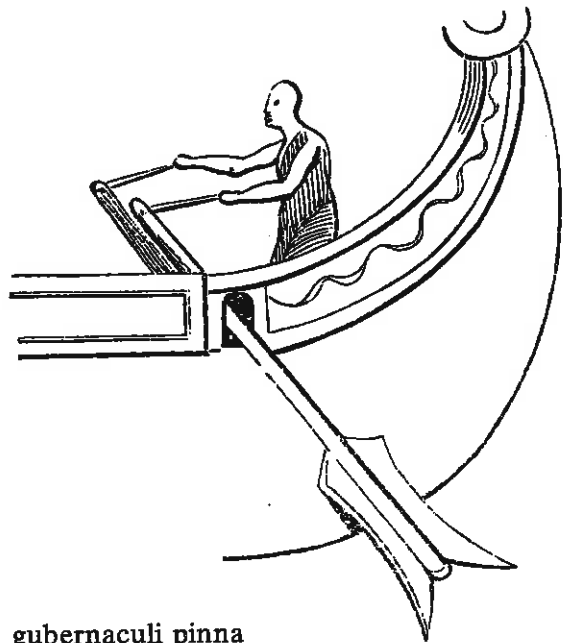
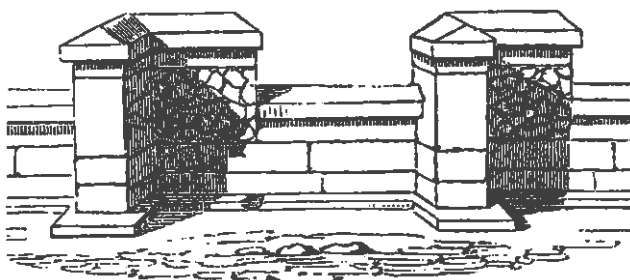

gubernaculi pinna

**pinus** -us (vel -i), f.

est arbor ex earum genere, quae resinam fundunt, in magnam altitudinem se promittens, ramosa in vertice (*vertex*), folia habens capillamenti modo praetenuia, longa, mucrone aculeata et numquam decidencia. nucamentum pinus sacrum erat Baccho. *symbolum* vitae aeternae erat ideoque saepe in monumentis sepulcralibus invenitur.

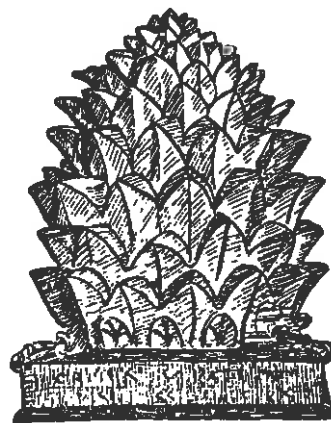

**piscator** -oris, m.

piscator est is, qui piscatur aut pisces captos publice vendit. capiuntur pisces hamo (*hamus*), reti (*rete*), aut *nassa*.

adi. piscatorius: piscatoria *navis*; in *taberna* piscatoria vel in foro piscatorio pisces veneunt.



**piscina** –ae, f.

- a) piscina est lacus vel stagnum, in quo vivi pisces coercentur.
- b) quoniam in piscinis etiam homines natare

solebant, omnes in hunc usum collectae aquae, sive frigidae sive calidae, piscinae dicebantur, quamvis in his nihil piscium sit. (*balneum*)

**pistillum** –i, n.

pistillum est instrumentum, specie clavae (*clava*), quo grana aliaeque res in mortario (*mortarium*) teruntur.



**pistor** –is, m.

qui farinam subigit panemque conficit.

Plinius, N. H. 18, 107:

„pistores Romae non fuerunt ad Persicum usque bellum ... ipsi panem faciebant Quirites (= Romani), mulierumque id opus maxime erat, sicut etiam nunc in plurimis gentium.“

pistrina est officina pistoris.



opus caelatum sarcophagi Romani: in parte superiore aratores agrum laborant, in parte inferiore ad dextram molam (*mola*) agitant, ad sinistram pistor panes in fornacem (*fornax*) immittit

## pittacium —i, n.

est schedula brevis seu membranae aut chartae particula, quae alicui rei vel pice vel cera aliave re affigitur, et paucis verbis perscribitur memoriae causa.

Petronius, Sat. 34, 6:

„allatae sunt amphorae vitreae diligenter gypsaetae, quarum in cervicibus pittacia erant affixa cum hoc titulo: Falernum Opimianum annorum centum.“

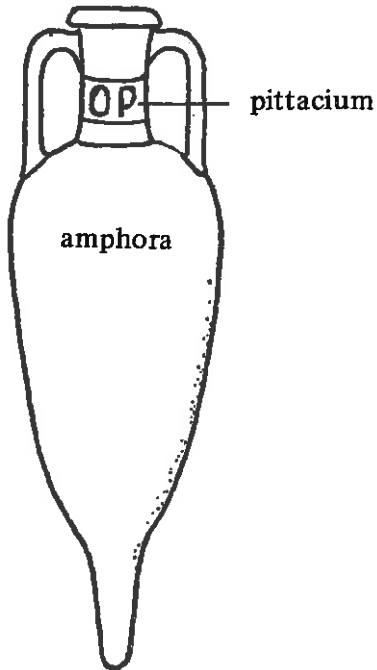

## plaustrum —i, n.

est carrus, vehiculum magnis oneribus ferendis aptum, praesertim apud rusticos. Scythae in plaustris habitasse dicuntur, de quibus Horatius, carm. 3, 24, 9/10:

„campestres melius Scythae,  
quorum plaustra vagas rite trahunt domos.“  
plaustris sacra Cereris eiusque ministras Athenis  
et Romae vectare mos erat.

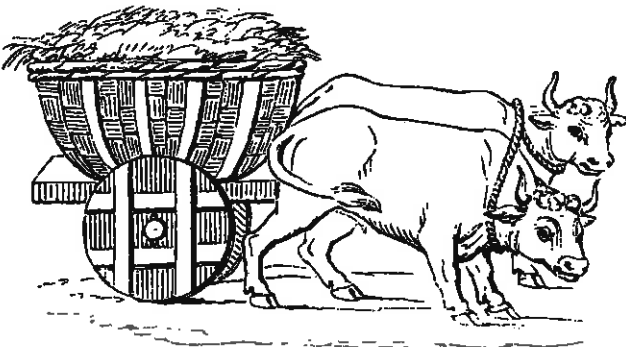

## pluteus —i, m.

est machina militaris ex tabulis, asseribus, cratibus (*crates*), qua milites protecti ab iniuriis hostium opus faciunt.

plutei etiam dicuntur tabulae in armariis (armarium) sustinendis libris aliisque rebus aptae.

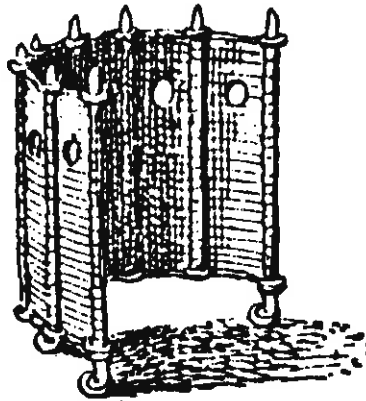

## pomarius —i, m.

est pomorum venditor ut in opere caelato sarcophagi describitur.

pomarium, —i, n. est locus pomiferis arboribus consitus, pometum.

Varro, r. r. 1, 2, 6:

„non arboribus consita Italia est, ut tota pomarium videatur?“

pomarium item est locus in villa, ubi poma decerpta conduntur. (*cella*)



## pomerium –ii, n.

pomerium est locus intra et extra murum urbis, spatium liberum, quod neque habitari neque arari fas est.

Livius, 1, 44, 4:

„est ... locus, quem in condendis urbibus quondam Etrusci, quā murum ducturi erant, certis circa terminis inaugurato (*augur*) consecrabant, ut neque interiore parte aedificia moenibus continuarentur, ... et extrinsecus puri aliquid ab humano cultu pateret soli. (5) hoc spatium, quod neque habitari neque arari fas erat, non magis, quod post murum esset, quam quod murus post id pomerium Romani appellarunt; et in urbis incremento semper, quantum moenia processura erant, tantum termini hi consecrati proferebantur.“

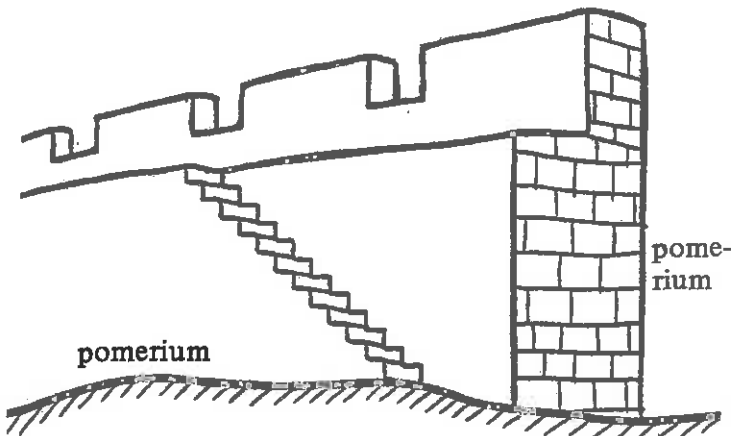

## pondus –eris, n.

a) pondus est quod adhibetur in *statera* vel lance (*lanx*) ponderandi gratiā.



b) pondus abstracte est gravitas, momentum, onus.

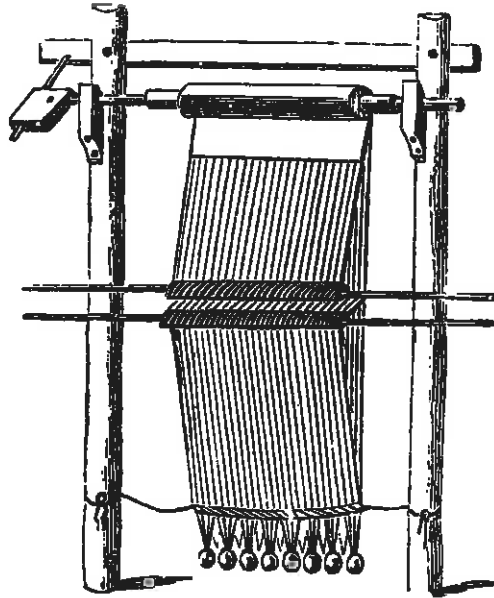

pondera iugi textorii

## pons pontis, m.

est id, quo super flumen, vel foveam (*fovea*), vel simile quid transimus.

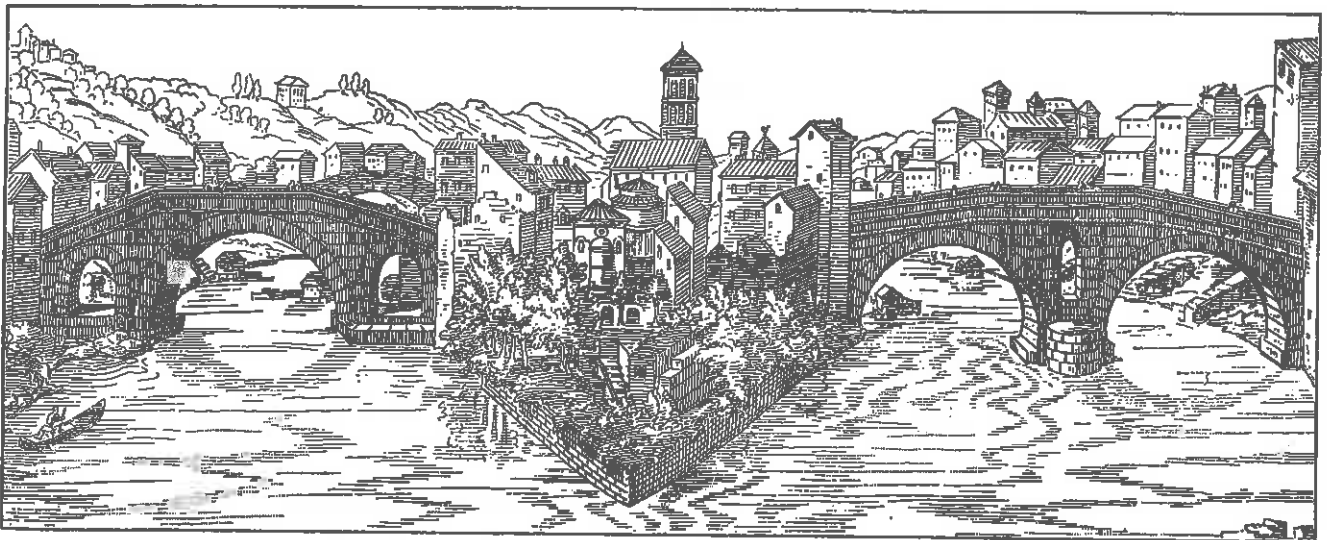

insula in medio Tiberi sita duobus pontibus cum urbe coniungitur: dextrā est Pons Fabricius, sinistra Pons Cestius. primus pons urbis Romae non longe ab hoc loco erat, sed erat pons sublicius (*sublica*)

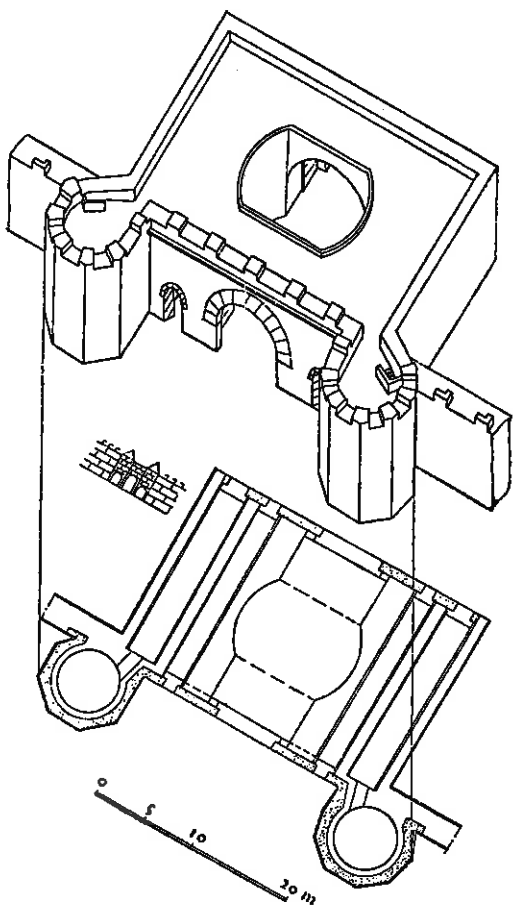

porta orientalis oppidi Helvetici Aventici

est aditus urbis, vel alterius loci vallo fossave muniti, qua res importantur vel asportantur.

Plautus, Bacch. 711:

„recta porta invadam extemplo in oppidum antiquum et vetus.“

„Hannibal ante portas“ dicitur cum res in summo periculo est.

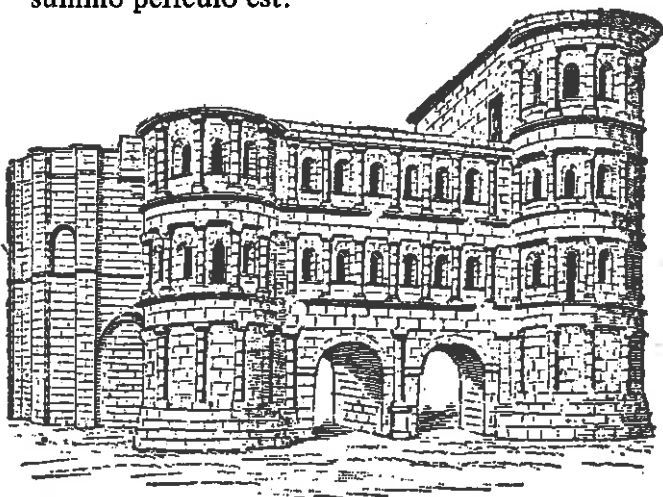

Porta Nigra quae vocatur, Treveris servata.

porticus, ut ait Isidorus, Orig. 15, 5, quasi porta, est locus amplus et longus, columnis aut pilis suspenso tecto munitus, cetera apertus, deambulationis umbraeque et imbrum vitandorum causā. erant privatae, quas ditiores sibi construebant tum in urbe, tum in agris: erantque

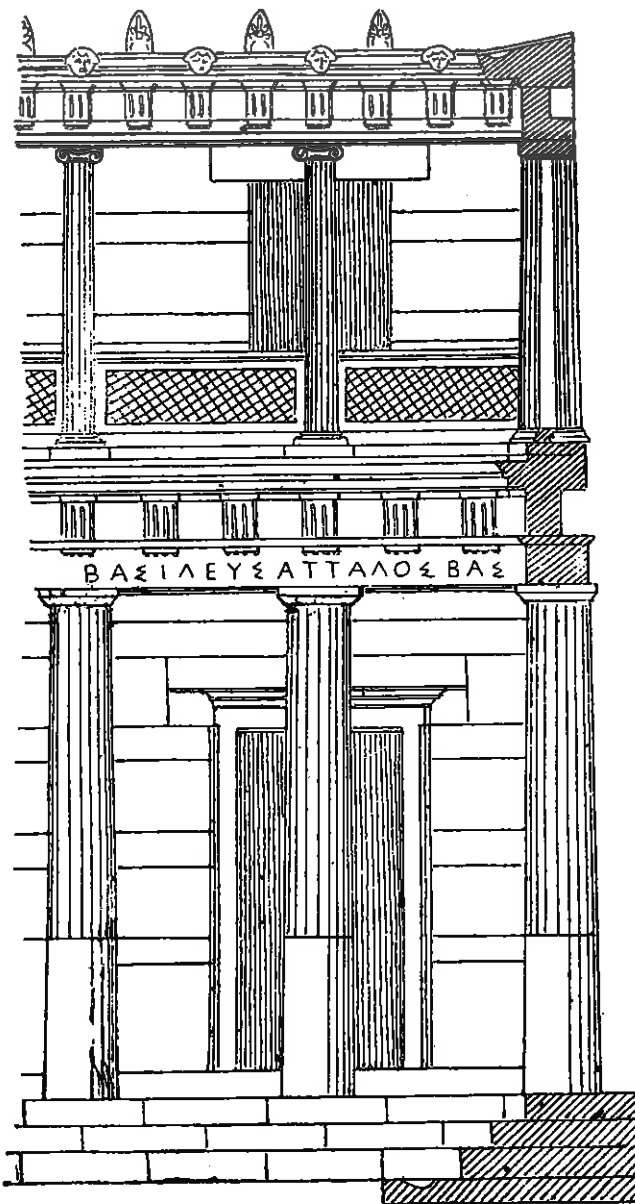

porticus regis Attali, Athenis in foro exstructa

publicae, ingenti sumptu exstructae, signis (*signum*), picturis, marmoribus exornatae, in quibus non solum otiosi homines deambulare solebant, sed aliquando ius dictum, senatum habitum, exceptos legatos legimus; item varia negotia agitata, sponsalia inita, merces pretiosas expositas etc.

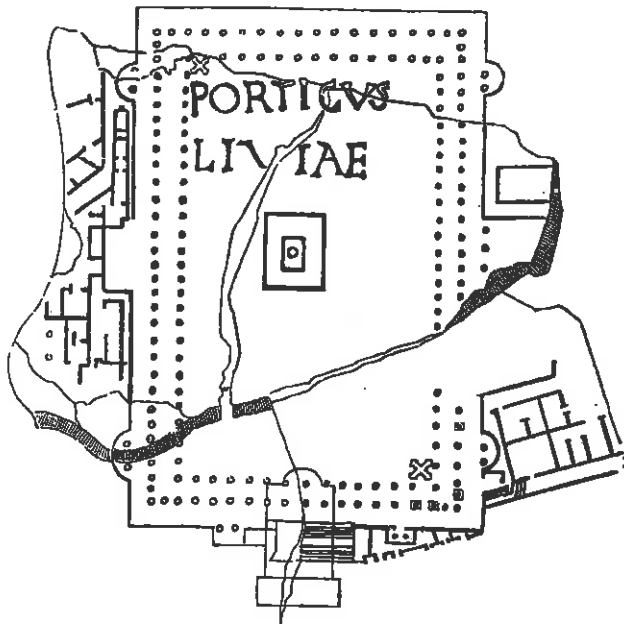

in „Forma Urbis“ in Capitolio Romano expositā  
ichnographia Porticūs Liviae videtur

### portus —us, m.

a) est locus in secessu litoris (*litus*) vel natura  
vel manu conclusus, aditu in mare patenti, ubi  
naves consistunt a ventorum iniuriā liberae.

formulae: „in portum ex alto invehi“, „in portum  
se recipere“.

b) per metaphoram portus est locus tutus.

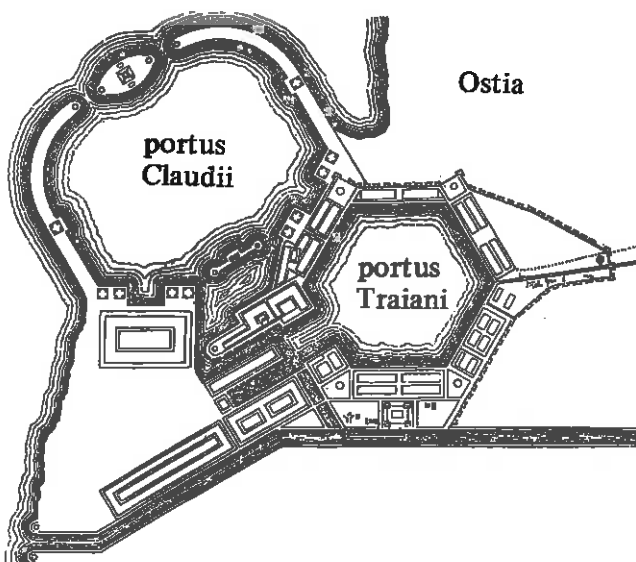

### praeco —onis, m.

praeco est minister publicus, praedicator, qui  
voce quaestum facit.

Cicero, Nat. Deor. 3, 34, 84:

haec sublata de fanis in forum protulit et per  
praeconem vendidit.



### praesaepe —is, n. (vel praesaepium, —i, m.)

praesaepe est locus saeptus, in quo pecudes sta-  
bulantur; est etiam locus in stabulo (*stabulum*),  
ubi pabulum iumentis apponitur. praesaepe  
dicitur etiam de quocumque loco clauso.

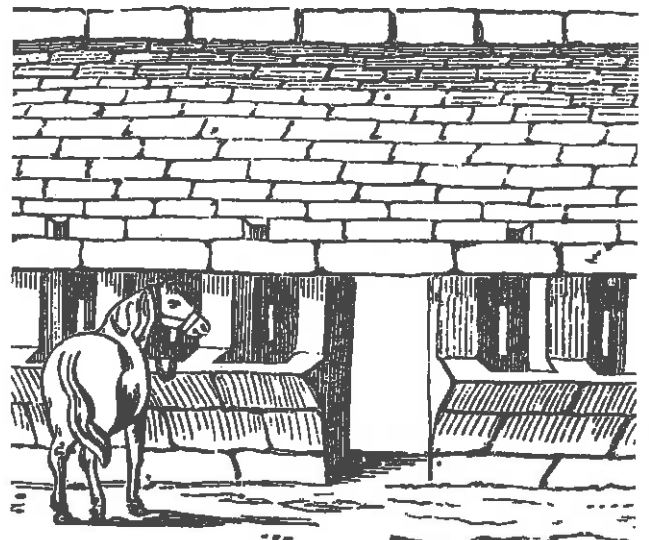

## precatio –onis, f.

est rogatio, obsecratio, preces, praesertim quae dis adhibentur.



gestus precandi vel orandi

## pressorium –i, n.

est instrumentum ad premendum.

Plinius Valerianus, 2, 17:

„cotonea purgare, tundere diligenter et exprimere in pressorio.“

prelum, –i, n.

est instrumentum, quo uva, oliva, aliudve quid comprimitur ad succum exprimendum vel ad aliquid aequum lucidumque reddendum.

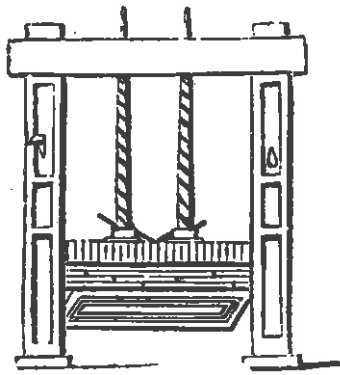

pressio in maius *pistillum* augetur eadem proportione (*proportio*) qua est *superficies* pistilli parvi ad superficiem pistilli magni.

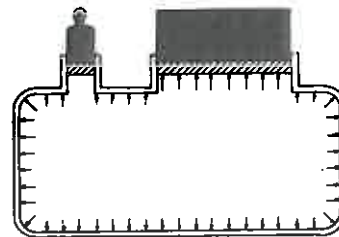
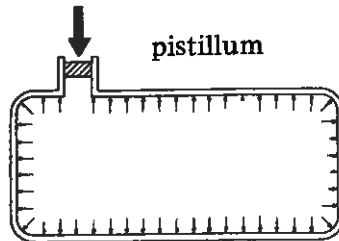

prelum hydraulicum

## proiectio –nis, f.

a) est proiectio nihil aliud quam superficialis aut solidae figurae in planum transcriptio.

b) proiectio figurae illuminatae e cubiculo illuminato in cubiculum obscurum ut figura ex

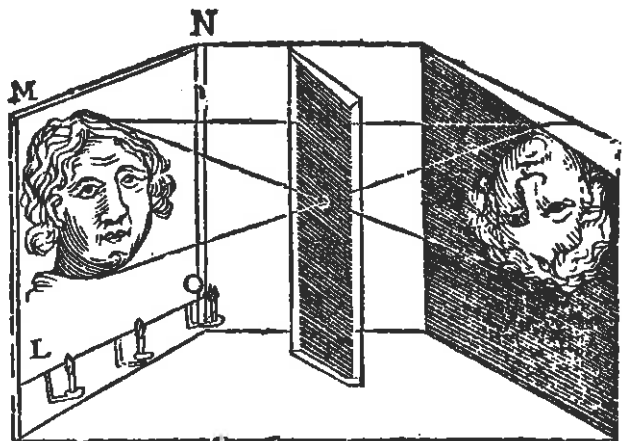



opere Athanasii Kircher, cui nomen est „Ars magna lucis et umbrae“, sumpta demonstrat. Hoc modo Athanasius Kircher imaginem explicat: „Imaginem ... in chartā tenui depictam immergas oleo, hanc siccā includes lateribus fenestrae MONL. Dico quod, si candelas quotlibet posueris in locis LO, ante imaginem per foramen si quod fieri debet in pariete interiacente inter cubiculum illuminatum et obscurum, species imaginis quam ostendere volueris in parietibus, aut in papyro ei obiecta, cum omni adumbratione sua repraesentabuntur, inversae quidem ...“ (*scaenographia*)

### proles –is, f.

est progenies, soboles, liber.

Tibullus, 1, 7, 55:

„at tibi subcrescat proles, quae facta parentis augeat...“

proletarius, –a, –um

proprie proletarii erant pauperrimi homines in plebe Romana. fere immunes erant a militia, excepto si tumultus maximus exstitisset. prolem rei publicae procreabant.

### prologus –i, m.

a) dicitur de principio fabulae, prooemium, in quo poeta excusatur aut defenditur vel fabulā commendatur. in prologo fabulae incipientis antecedentia exprimuntur, ut spectatores facilius fabulam intelligant.

b) est etiam prologus is ipse, qui prologum recitat.

Terentius, Hec. prol. 9:

„orator ad vos venio ornatu prologi.“



### prōpāgo –inis, f.

propago est ramus vitis, aut alterius arboris ab eā non recisus, sed in terram depressus atque obrutus, vel per vas fictile pertusum terrāque oppletum traiectus, ut radices (*radix*) agens renovetur et fructum ferat. translate significat proles, progenies. propāgāre est arborem depresso in terram ramo renovare et multiplicare. translate: extendere, proferre, amplificare. Collegium de propagandā fide: ex hac expressione derivatum est novum substantivum hodierni temporis \*\*\*propaganda: actio propagandi vel fovendi aliquid.

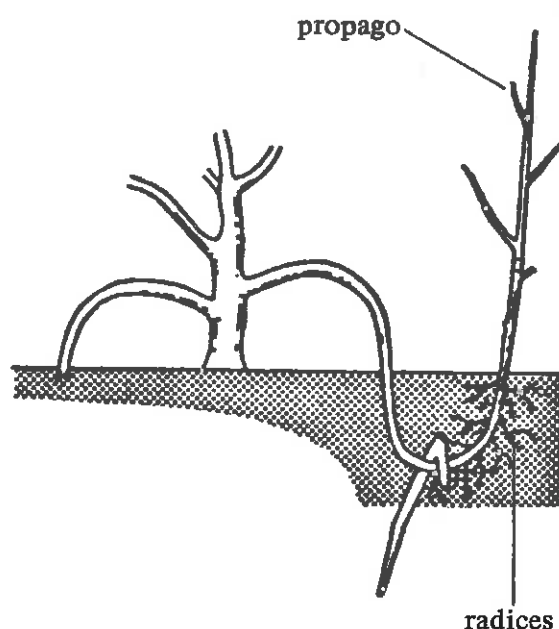

### proportio –onis, f.

proportio est comparatio et respectus unius rei ad aliam: a „pro“ et „portio“; quia saepe „pro portione“ Latine dicebatur, paulatim coalescentibus usu frequenti duabus vocibus „proportio“ facta est.

\*proportio divina = \*\*\*sectio aurea, quod autem nomen saeculo decimo nono huic proportioni datum est. proportio divina a Pythagoreis inventa est.

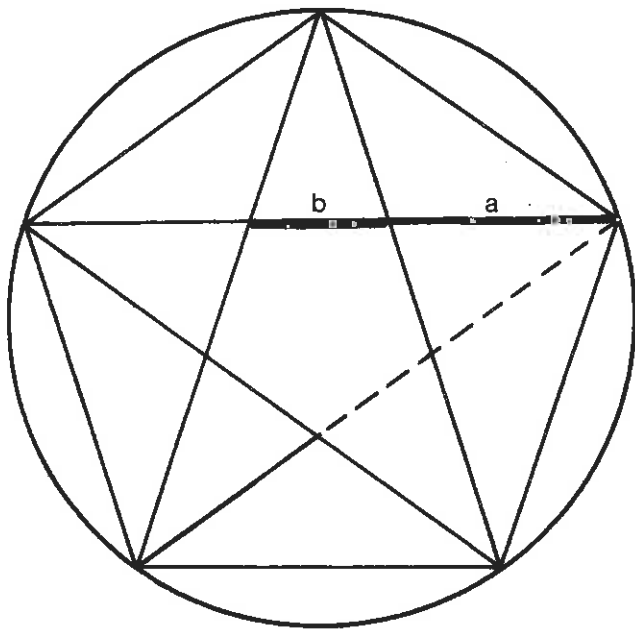

pentagramma sectionem auream praebens:  
 $b : a = a : (a + b)$

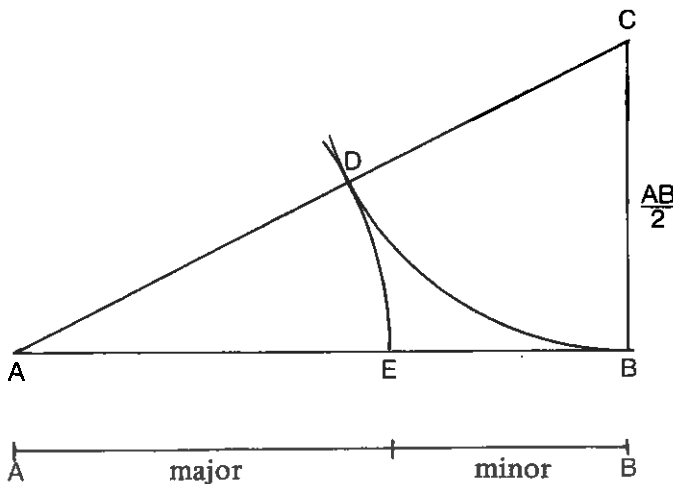

constructio sectionis aureae  
 $EB : AE = AE : AB$

**proportionalitas:**

Cassiodorus, de geometria 6:

„proportionalitas in tribus, ut minimum, terminis invenitur, cum proportionales eidem eiusdem magnitudinis proportionales esse dicuntur, praecedentes consequentibus, et praecedentibus consequentes.“

multis in floribus aliisque a natura procreatis rebus proportio divina reperitur, ut haec exempla monstrant:

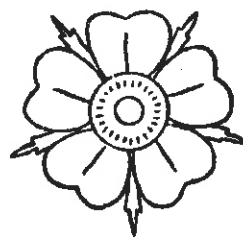

Rosa canina

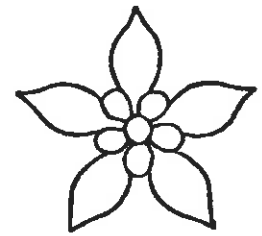

Aquilegia

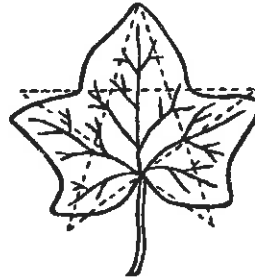

folium Hederae

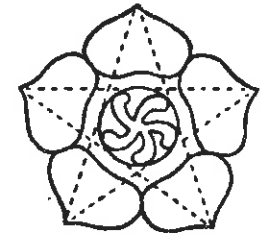

Campanula

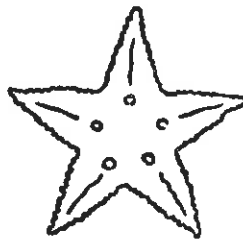

Asterias rubens

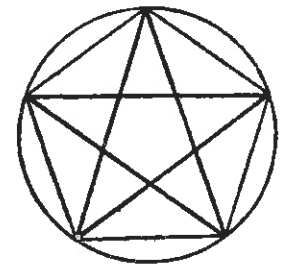

**propugnaculum —i, n.**

propugnaculum est locus munitus, unde pugnari potest defendendi causā, ut vallum, moenia, arx, aut turris in nave (navis) constructa.

Tacitus, Hist. 3, 34:

„Cremona ..., propugnaculum adversus Gallos.“

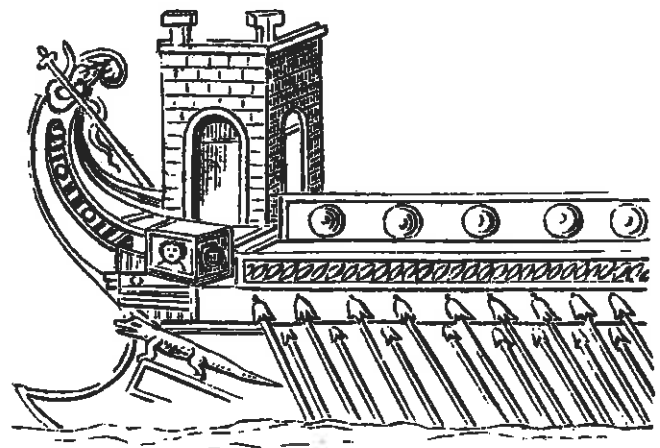

## prora –ae, f.

prora est anterior pars *navis*, sicut *puppis* posterior. *navis* cum portum (*portus*) intrat, *prorā* intrat: cum vero religanda est, convertitur et *puppi* religatur, *prora* autem mare spectat (*proreta*).

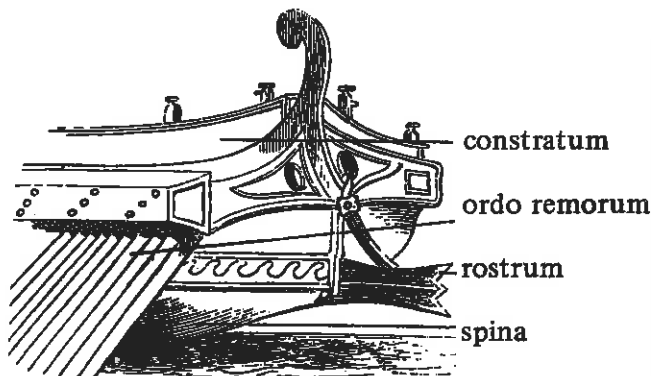

## proreta –ae, m. vel proreus

in *navis* *prora* sedet, ibique ventos captat, et de eorum conversionibus gubernatorem monet, docet etiam, *rupes* et *scopuli* ubi sint, ut is converso *clavo* (*clavus*) eos declinet.

Rutilius, de *reditu* 1, 455, 56:

„despectat *prorae* *custos*, *clavum*que sequentem dirigit, et *puppim* (*puppis*) voce monente regit.“

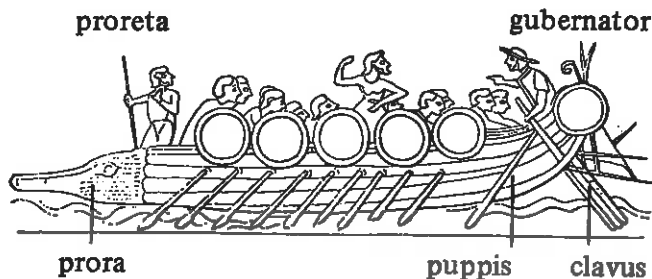

## pruna –ae, f.

*pruna* est *carbo* *vivus* (aut *ardens*).

Servius, ad *Aen.* 11, 788:

„*pruna*, quamdiu ardet, dicitur.“

Vergilius, *Aen.* 5, 103:

„*subiciunt* *veribus* *prunas* et *viscera* *torrent*.“

*caro* autem in *crate* (*crates*) *ferrea* aut in *veru*, *subiectā* *prunā* (aut *carbone* *ardente*) *torretur*. (*veru*)

## pulvinus –i, m.

*pulvinus* est *lectulus* *brevis* *plumā* vel *tomento* *aliāve* *re* *mollī* *fartus*, quem *sedendi* aut *quocumque* *modo* *fulciendi* *corporis* *causā* *supponimus*.

pulvinar –aris, n.

in *re* *sacrā* *usurpatur*. *erant* *autem* *pulvinaria* in *templis* *lectuli* *plumā* aut *tomento* *farti*, qui *deis* *sternebantur*, *decretā* *supplicatione* (*supplicatio*), *iisque* *simulacra* *imponerentur*, *cibis* *appositis*. (*lectisternium*).



pulvinus in sellā ponitur



pulvini in triclinio

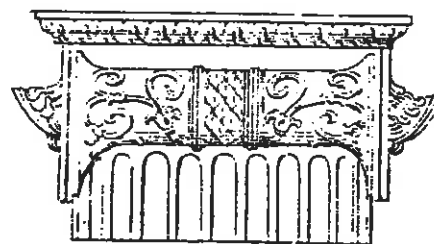

pulvinus in *capitulo* *columnae* *Ionicae*

## pupa —ae, f.

pupa est imaguncula quaedam puellaris, ex linteo insuta, tomento infarcta, vestibus amicta, qua virgo in prima pueritia luditare solebat, et quam pubertati vicina tamquam virginittatis suae *insigne* Veneri offerebat, ut fauste futurum matrimonium cederet. pueri eodem tempore bullam (*bullā*) Laribus (*Lares*) offerebant.

demin. *pupilla*, —ae, f.

a) plerumque significat filiam orbam parentibus et sub tutore agentem.

b) praeterea pupilla dicitur *foramen oculi* (*oculus*) per quod species rerum ad visum transmittuntur.



## puppis —is (acc. —im, abl. —i), f.

puppis est pars *navis* posterior, altior, ornatio et honoratio, ubi *gubernaculum* et *clavus*.

*Vergilius*, *Aen.* 3, 130:

„prosequitur surgens a puppi ventus euntes.“  
*ventus secundus a puppi flat.*

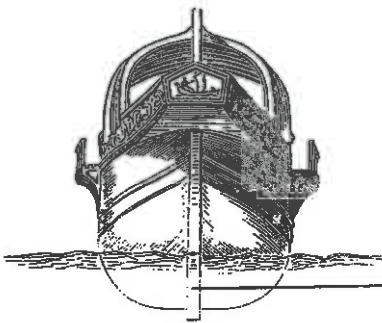

carina

## purpura —ae, f.

est concha marina (ut *conchylium*, et *murex*). ex eius suco color purpureus efficitur. captis muricibus enim eximebatur vena et addito sale macerabatur triduo: deinde in *cortina* plumbea decoquebatur. lana immissa quinque horis potabat, rursusque immergebatur, ut totam saniem ebiberet, indueretque colorem illum, qui tanto in pretio quondam fuit.

*purpuratus* est is, qui purpurā indutus, ornatus est, et speciatim purpurati dicuntur, qui circa reges sunt et apud eos dignitate et gratia antecellunt.

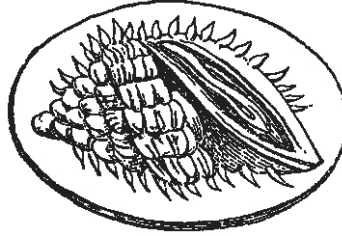

murex in  
tinctoris sigillo

## puteus —i, m.

est locus, qui perpetuas habet aquas ex terrae venis manantes, non tamen fontium (*fons*) more foras erumpentes.

*puteal* —alis, n. est saeptum marmoreum, rotundum, puteo circumdatum, ne incautius accedentes in praecipiant.



girgillus

puteal

puteus

## pyxis —idis, f.

pyxis est vasculum e buxo excavatum, teres, et operculo in ipsum vas intrante clausum et translate accipitur pro vase parvo ex quacumque materia, ad servanda ea, quae plurimum interest bene clausa servari, ne corrumpantur, ut medicamenta, venena, odores et huiusmodi.

*Suetonius*, *Nero* 12, 9:

„barbam primam posuit, conditamque in auream pyxidem ... Iovi Capitolino consecravit.“



pyxis

umbraculum

**quadriga** –ae, f. / **quadrigae** –arum, f. pl.

quadriga sunt quattuor equi ad currum trahendum apti; item currus a quattuor equis tractus. in fastigio (*fastigium*) Capitolii quadrigae fictiles fuerunt ornatūs gratiā, currum Iovis referentes. poetice quadrigas etiam Soli, Aurorae aliisque deis tribuerunt.



nummus quadrigatus

**quadrivium** –i, n.

a) quadrivium est locus, ubi via alteram viam secat, *area*, unde viae in quattuor regiones oriuntur.

b) \*\*quadrivium nominantur quattuor *artes liberales* difficiliore: arithmetica, geometria, astronomia, musica.

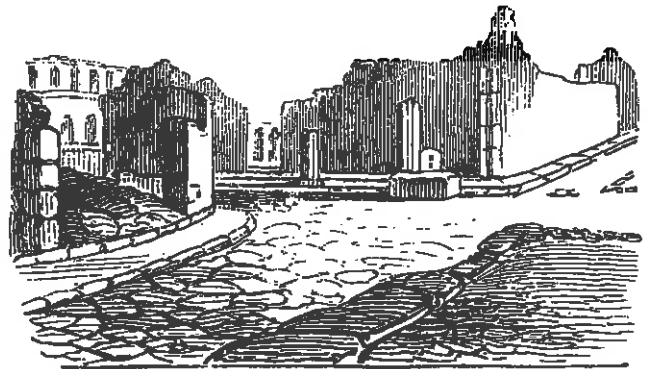

**quaternio** –onis, m.

quaternio est chartarum *fasciculus* e quaternis foliis complicatis, in quo scribi solet. Itali nunc „quaderno“ vocant.

**Rufinus**, *Invect. in Hieronymum* 2, 8:

„fratres in meis cellulis manentes in monte Oliveti quam plurimos ei Ciceronis dialogos descripserunt, quorum et ego quaterniones cum scriberent, frequenter in manibus tenui et relegi.“ in initio textūs „*incipit*“ scriptum est, in fine „*explicit*“, haec verba a formā librorum apud veteres in volumen complicatorum derivantur, nam ut libri legi possent, evolvendi atque explicandi erant. *explicit* dicitur pro: *explicit*(us est liber).

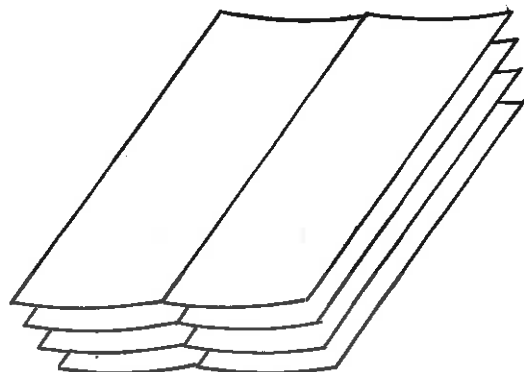

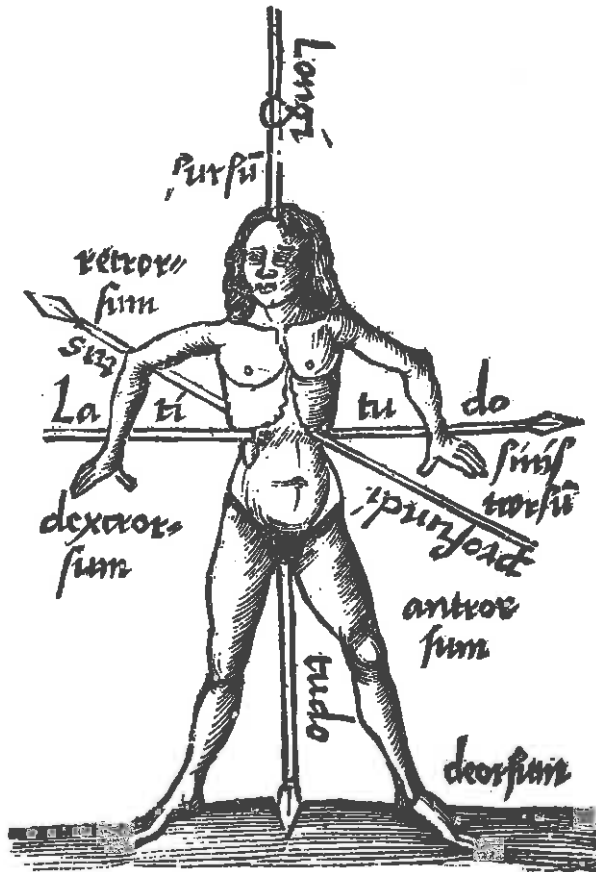

imago sumpta est e Margarita Philosophica Gregorii Reisch (1503)

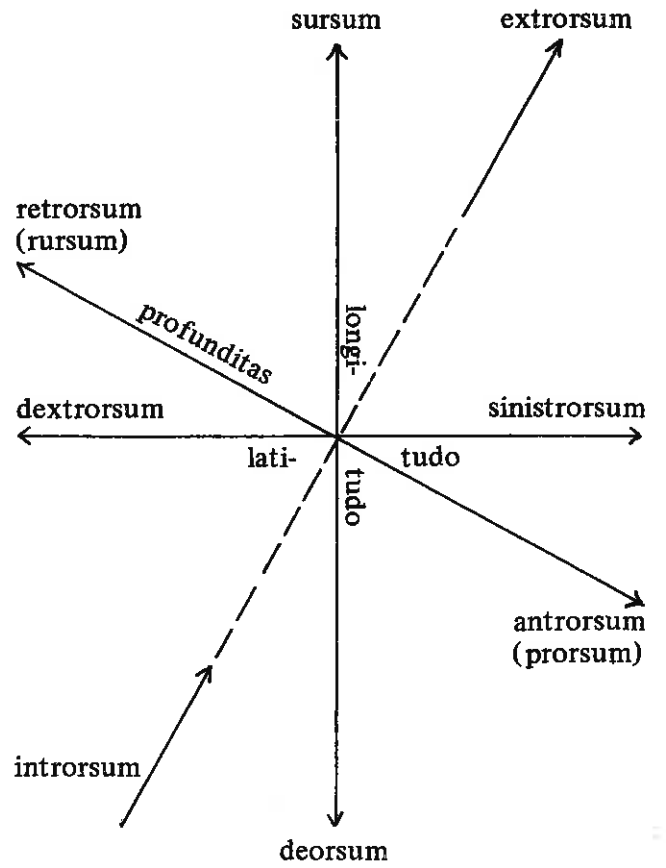

## radius -i, m.

- a) est bacillus seu virga.  
b) speciatim est virga mensurum, mathematicorum, astronomorum, ad metiendum et figuras lineasque in pulvere delineandas.



radius astronomi

Cicero, Tusc. 5, 23, 64:

„humilem homunculum a pulvere et radio excitabo, ... Archimedem.“

c) radius dicitur linea recta, quae a centro circuli ad circumferentiam ducitur.

d) radii dicuntur regulae in rota, quae hinc modulo, illinc cantho seu absidi inseruntur.

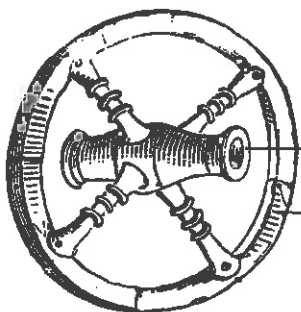

modiolus

canthus

radii rotae

e) a similitudine radius est splendor, qui e sole, stellis, igne emittitur.



radii coronae

## radix -icis, f.

- a) radix est ima pars plantae, quae terrae infigitur et insistit et inde succum trahit. (*propago*)  
b) translate dicitur de imā parte montis.

Caesar, B. G. 7, 36: „erat e regione oppidi collis sub ipsis radicibus montis egregie munītus.“

Plinius, H. N. 16, 127:

„magna et radīcum differentia; copiosae fico ..., breves et angustae mālo ..., crassiores lauro ..., robori carnosae.“

radīcitus = ab radīce, ab imis radīcibus, vel unā cum radīce.

Cicero, nat. deor: 1, 43, 121:

„Epicurus vero ex animis hominum extraxit radīcitus religionem.“

eradicare = una cum radīce plantam evellere.

## raeda -ae, f.

raeda est vehiculum quattuor rotarum gestandis hominibus et sarcinis idoneum.

Cicero, ad Att. 6, 1, 25:

„Vediū mihi obviam venit cum duobus essēdis (*essēdum*) et raedā equis iunctā et lectīcā et familiā magnā.“

Suetonius, Caes. 57:

„longissimas vias incredibili celeritate confecit expeditus, meritoriā raedā.“

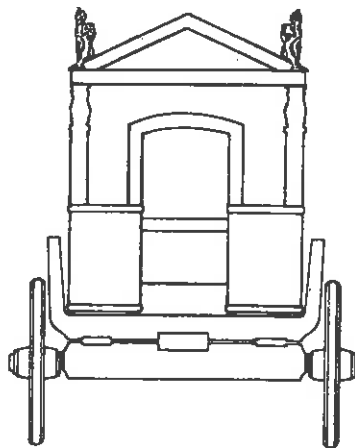

raeda duobus equis iuncta, opus caelatum Viruni [Maria Saal] in Provinciā Noricā (*Raetia*) inventum.

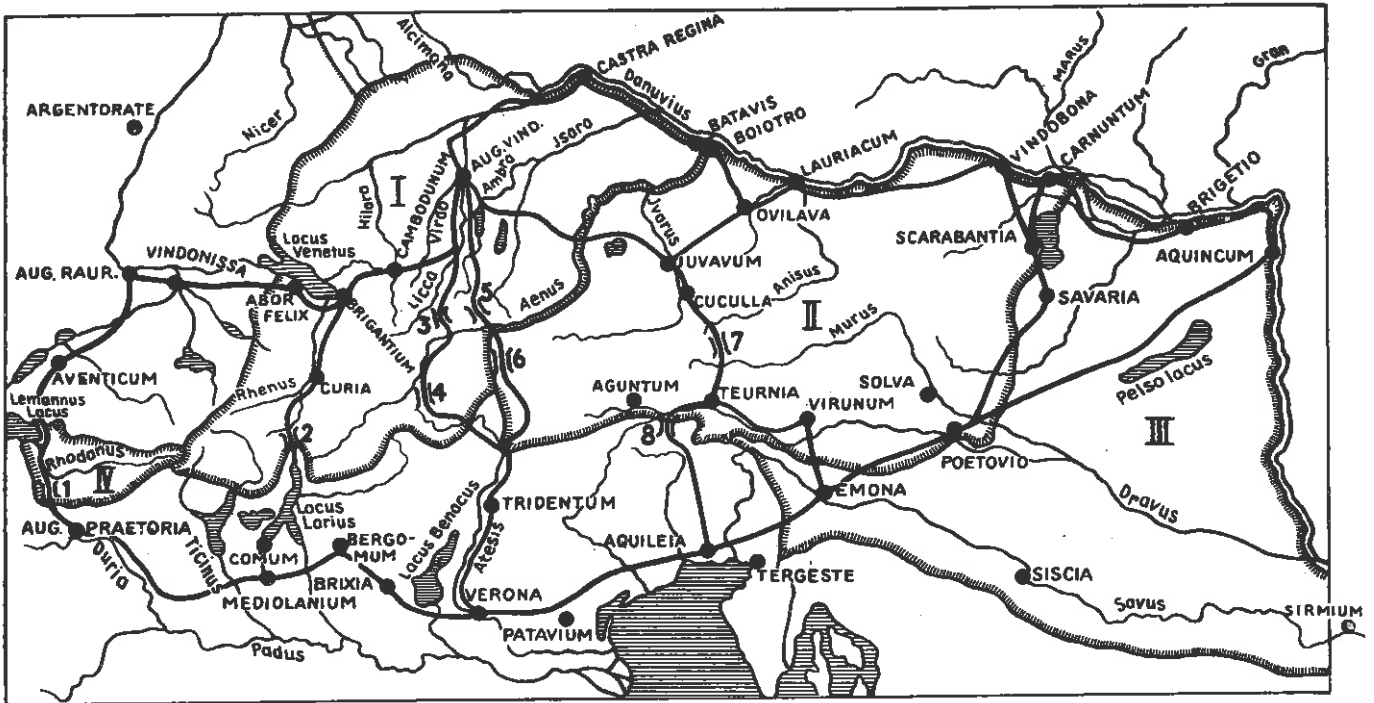

I Raetia, II Noricum, III Pannonia, IV Vallis Poenina

1–8 oppida, viae, saltus Alpium

rana –ae, f.

rana (esculenta) est animal palustre, in aquā et terrā vivens (= amphibium).

Horatius, sat. 1, 5, 14s:

„... mali culices (*culex*) ranaeque palustres avertunt somnos ...“

Vergilius, Georg. 1, 378:

„et veterem in limo ranae cecinere querelam“.

proverbium: inflat se tamquam rana; hoc proverbium ad Phaedri fabulam 1, 24, „de rana rupta et bove“ spectat.



raster –tri, m. vel rastrum –i, n.

raster est instrumentum rusticum dentatum, ferreum plerumque, interdum ligneum.

Plinius, N. H. 18, 180:

„aratione per transversum iteratā, occatio sequitur, ubi res poscit, crate (*crates*) vel rastro.“



ratis –is, f.

ratis est connexarum trabium compages, quae per aquam agitur, usum navium praebens.

Paulus Diaconus, p. 272, 8 M.:

„rates vocantur tigna colligata, quae per aquam



aguntur; quo vocabulo interdum etiam naves significantur.“

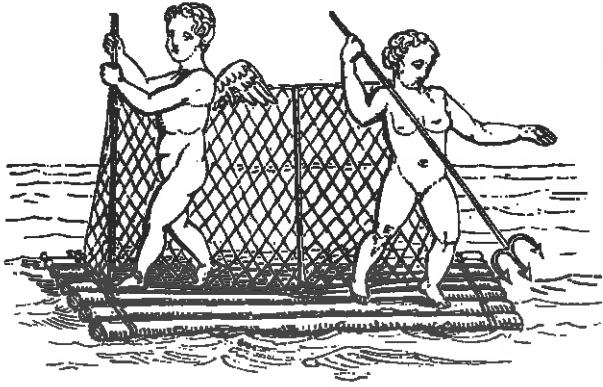

### regio —onis, f.

regio est aliquoversum directio, orbita, linea. Curtius, 8, 13, 23:

„traicere amnem cum ceteris copiis in regionem insulae, de qua ante dictum est, parabat.“

caeli regiones quattuor sunt: septentrio, meridies, ortus, occasus (*regiones caeli*).

regio est etiam pars terrae magna aut parva, tractus, plaga, locus.

Cicero, Nat. Deor. 1, 10, 24:

„terrae maximas regiones inhabitabiles atque incultas videmus, quod pars earum appulsu solis exarserit, pars obriguerit nive pruinaque longinquo solis abscessu.“

in urbe est pars maior, quae in vicos rursus dividitur. urbs Roma in quattuor regiones dividebatur: Suburbanam, Esquilinam, Collinam et Palatinam.

\*\*\*hodie regio Basiliensis: partes Helvetiae, Franciae, Germaniae circum urbem Basileam sitas amplectitur, quae iisdem necessitatibus coniunctae sunt.

regiones dictae sunt etiam partes, in quas Italia divisa est, quaeque Augusto imperante undecim fuerunt.

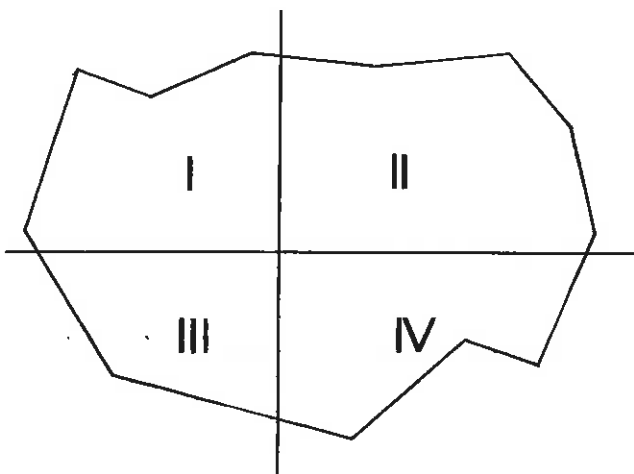

### regiones caeli

et tempora

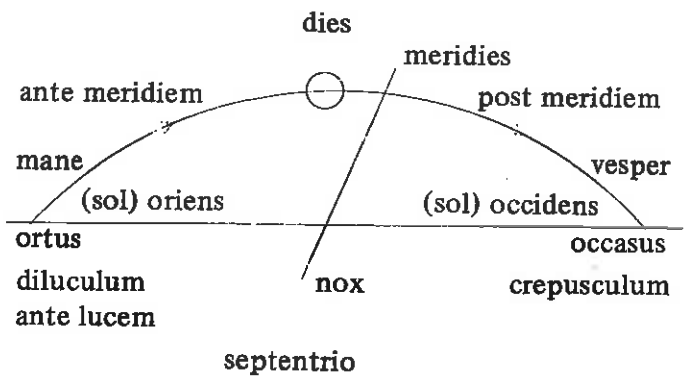

adiectiva:

ante lucem:	antelucanus
mane:	matutinus
ante meridiem:	antemeridianus
meridies:	meridianus
post meridiem:	postmeridianus
vesper:	vespertinus
dies:	diurnus
nox:	nocturnus
oriens:	orientalis
occidens:	occidentalis
septentrio:	septentrionalis

### rete —is, n.

rete est instrumentum, quo aves, ferae, pisces capiuntur; *plaga, laqueus*.

Cicero, Nat. Deor. 2, 48, 123:

„(araneolae) quasi rete texunt, ut, si quid inhaeserit, conficiant.“

verbum: *irretire* = reti involvere et capere aliquid.



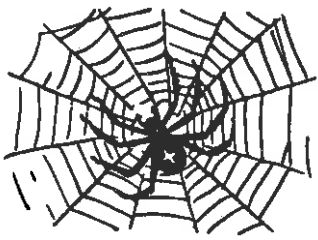

tela, vel rete,  
araneae

### retiarius –i, m.

hoc nomine speciatim dicebatur alter ex gladiatoribus in arena depugnantibus: fuit enim genus gladiatorii certaminis, in quo duo pugnabant, quorum alter retiarius vocabatur, quod tunicatus fuscina et rete gestaret, quo adversarium involveret et implicaret.



fuscina

retiarius

### reticulum –i, n.

generatim est parvum rete, vel rete solito angustioribus maculis contextum. reticulum nominatur etiam fascia vel pileolus (pileus) in modum retis a mulieribus praecipue usurpatus capillis continentis (vestimenta).

\*\*\*reticulum hodie nominatur instrumentum reticulo instructum, quo pila in campum adversarii reicitur.

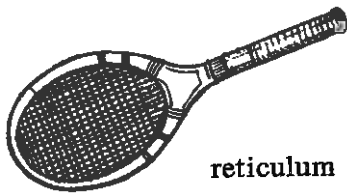

reticulum

### rivus –i, m.

rivus est aqua fluens a fonte (fons) deducta; decurrit inter ripas.

#### formula dicendi:

e rivo flumen facere = rem minimam nimis amplificare.

rivales sunt ii, qui in agris rivum habent communem et propter eum saepe contendunt.

#### Ulpianus, dig. 43, 19, 1:

„si inter rivales, id est qui per eundem rivum aquam deducunt, sit contentio ...“

### Phaedrus, 1, 1, 1s:

„ad rivum eundem lupus et agnus venerant, siti compulsi ...“

translate: rivales sunt, qui eiusdem mulieris amore tenentur.

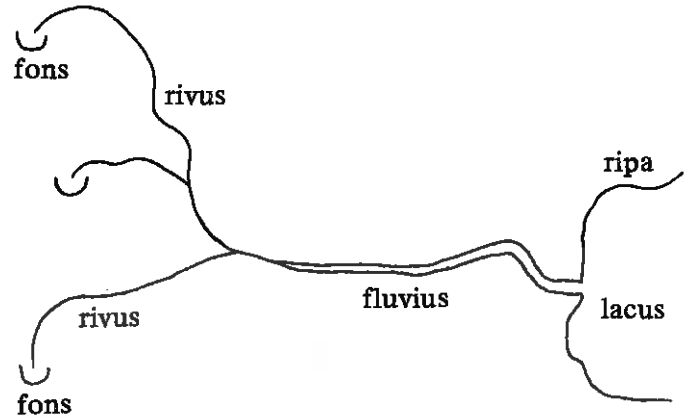

### rogus –i, m.

rogus est strues lignorum, in qua imposita cadavera cremabantur.



### rostra –orum, n. pl.

est suggestus et locus circa positus, ante Curiam Hostiliam. quas enim primum hostiles naves Romani bello Latino ab Antiatribus ceperunt,



nummus  
M. Lollii  
Palicani,  
rostra in  
foro exhibens

earum rostris in victoriae monumentum, eam partem fori exornari placuit, ubi suggestus erat seu pulpitum, cuius figuram exhibet nummus G. Lolliae, quo contiones ad populum habebantur.

Cicero, in Pis. 3, 7:

„ita est a me consulatus peractus ... ut semper in rostris (sc. apud populum in contione) curiam, in senatu populum defenderim.“

## rostrum –i, n.

a) est os, quo animalia (exempli gratia aves) cibum capiunt.

b) rostrum *navis* est trabs aenea aut ferrea, prominens ex prorae (*prora*) parte inferiore, rostri modo, unde, si navis remigio agigaretur in hostilem navem, haec perforari poterat et deprimi.

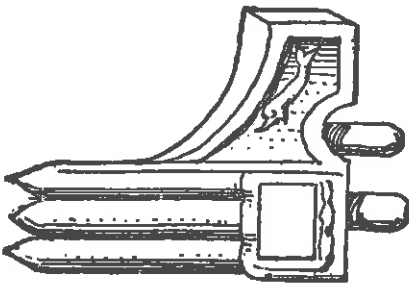

rostrum navale



prora navis cum rostro

## rota –ae, f.

est instrumentum versatile, rotundum, *orbis*, quo circumacto currus procedit: eius partes sunt modiolus, radii, orbis (canthus).

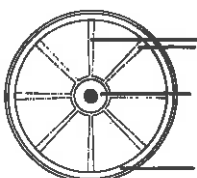

radii

modiolus, quo axis rotae continetur

orbis

rota tractoria in usu est ad onera magna sublevanda. rota machinae tractoriae calcantibus (*calco*) operariis versatur, oneraque in altitudinem tollit ut in imagine Capuae inventā, ubi columna erigitur hāc machinā.

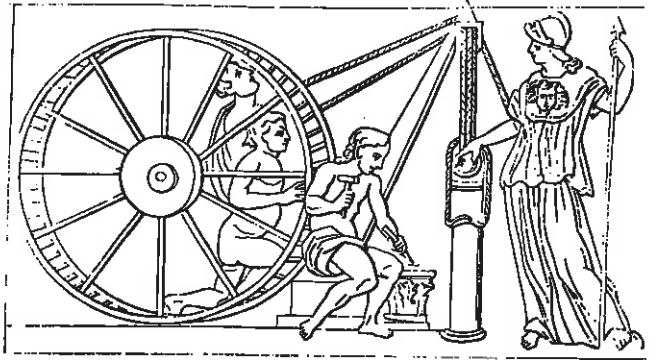

## rota aquaria

Vitruvius, 10, 5, 1:

„(rotae) modioli aquam haurientes et in summum referentes, sine operariorum calcatura, ipsius fluminis impulsu versatae, praestant, quod opus est ad usum“ h. e. sine ope hominum qui calcando rotas versent. (*calco*)

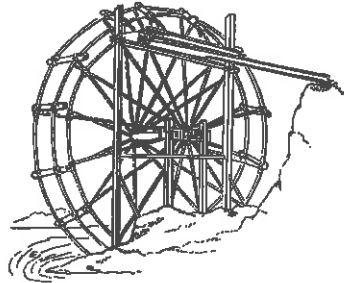

## rota Fortunae

Fortuna dea in media rota sedet. in orbe (orbis) rotae homines circumvolvuntur: rex in solio sedet („regno“), fertur deorsum („regnavi“), in infimo est („sum sine regno“), denuo sursum fertur („regnabo“) (*quorsum*).

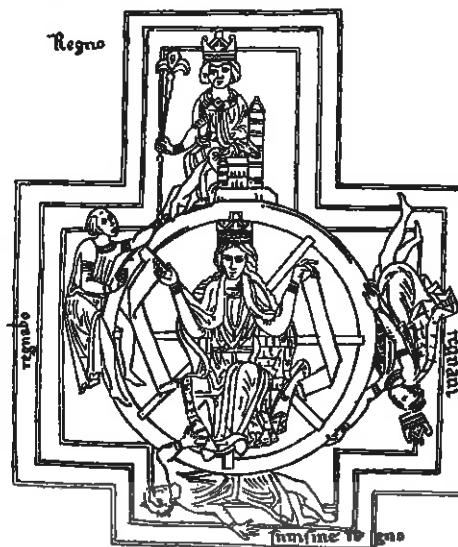

imago Fortunae sumpta est e manuscripto Medii Aevi, quod multa carmina popularia Latina continet et titulum „Carmina Burana“ portat.

## rotulus —i, m.

rotulus est surculus cylindricus. volumen papyri vel chartae duobus rotulis explicatur ut legi possit. ornandi causā saepe in extremā parte rotuli umbilicus aureus vel eburneus apponitur.

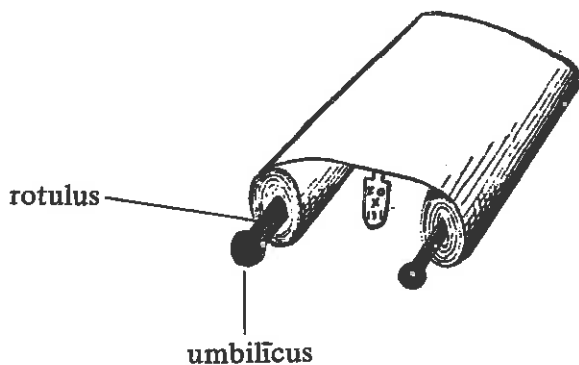

## rudicula —ae, f.

deminutivus est vocabuli „rudis“. rudicula est instrumentum, quo agitantur ea, quae coquuntur. (*rudis*)

Plinius, H. N. 34, 176 de colore quodam praeparando: „coquitur in patinis (*patina*), misceturque rudiculis, donec rubescat.“

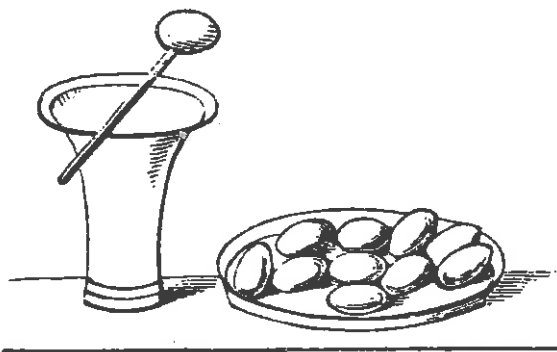

## rudis —is, f.

a) rudis est ligula seu spatha, id est virga lignea, quā res agitantur et miscentur, ut fit in iis, quae coquuntur.

Cato, r. r. 79:

„coquito, versatoque crebro duabus rudibus.“

b) rudis est virga impolita qualis erat, quā gladiatores olim, cum ipsis permitteretur a gladiato-

rio munere cessare, a praetore donabantur et publicā alebantur pecuniā. etiam hodie, qui a munere suo cessant, „rude donantur“. formula: rude donari = quocumque onere liberari, in otium restitui.

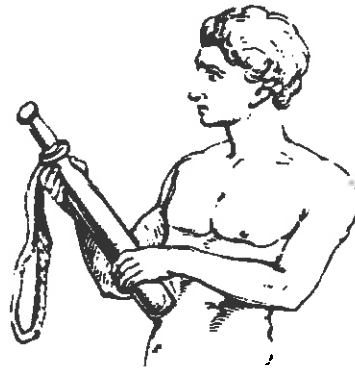

sacrificium —ii, n.

sacrificium est res divina, sacrum a sacerdote (sacerdos) peractum.

Augustinus, Civ. D. 10, 5:

„sacrificium ergo visibile invisibilis sacrificii sacramentum, i. e. sacrum signum est.“ (ara, lectisternium)

sacrificii utensilia: 1 ara turicrema, 2/11 bucranium cum vitta, 3 praefericulum, 4 ? , 5 securis et pelvis, 6 simpulum et malleus, 7 secespita (culter), 8 aspersorium, 9 acerra = custos turis (turibulum), 10 albogalerus (apex), 12 mappa vel mantele



sacrificium rusticum

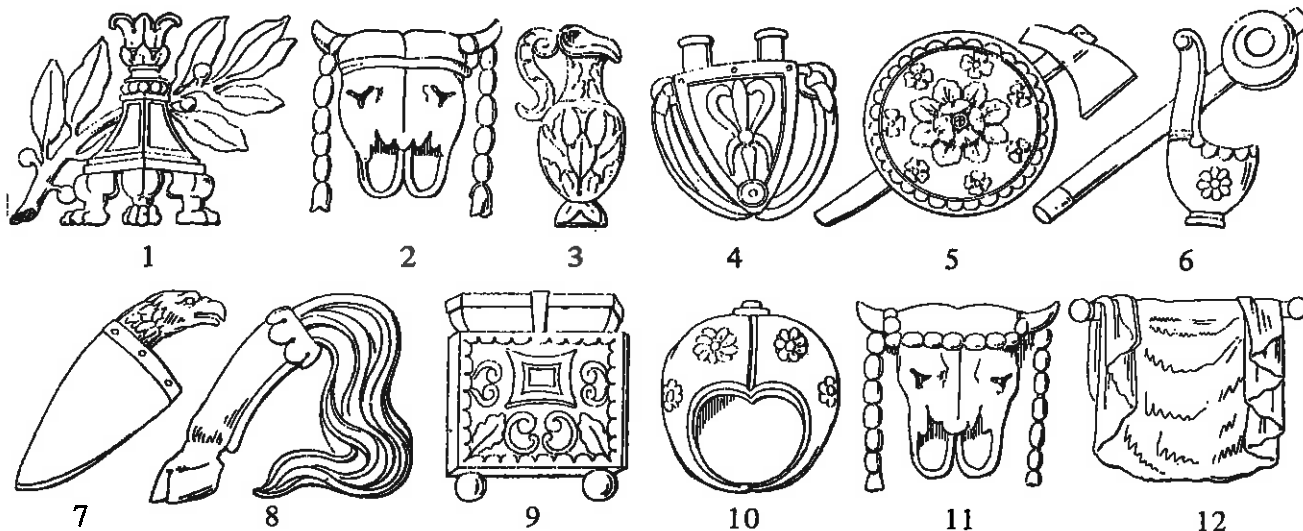

saepes —is, f.

saepes est saeptum ex lignis, ramis arborum, aut spinis consitis, quo clauduntur agri aut horti.

Ovidius, Ars am. 3, 562:

„cingenda est altis / saepibus ista seges.“

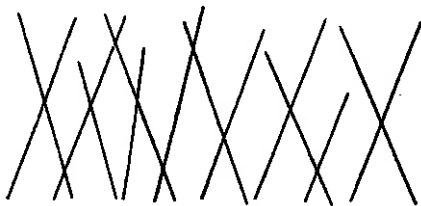

saepia —ae, f.

est genus marini piscis atrum humorem (quod atramentum dicitur) vomens, quo aquam circa

se adeo infuscat, ut ea se celet, et piscatoris manus effugiat.

Ovidius, Halieut. 18 ss:

„saepia tarda fugae, tenui cum forte sub unda  
depressa est, iam iamque manus timet illa  
rapaces,  
inficiens aequor nigrum vomit illa cruorem,  
avertitque vias, oculos frustrata sequentes.“

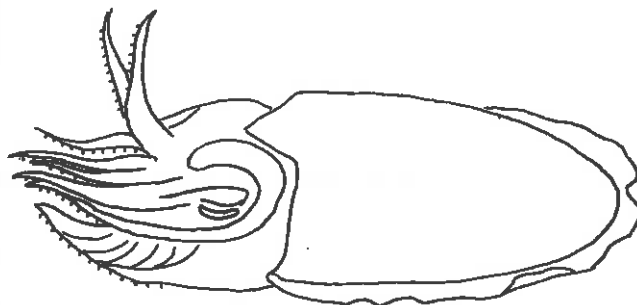

salmo –onis, m.

salmones sunt genus piscium, qui e montibus per vastissima flumina dulcium aquarum in mare descendunt, sub solari aestu autem a mari

per flumina in montes ascendunt agilitate saltūs loca abrupta superantes.



salmones fumo siccantur (1), in aquā percoquantur (2), sole torrentur (3). imago piscationem salmonum monstrat, qualis inter populos septentrionales perficitur. sumpta est haec xylographia ex Olai Magni Historiā de Gentibus Septentrionalibus (1555)

salus –utis, f.

a) salus est incolumitas, sanitas, vita, quies, bonum; cui opponitur exitium, perniciēs, morbus, pestis, mors seu nex.

Varro, r. r. 1, 2, 27:

„terra pestem teneto, salus hic maneto!“

b) Salus dea est habita, Aesculapii filia, templumque eius erat in summo Quirinali (in colle Salutaris).

in hoc disco argenteo, in Hispaniā invento, Salus dea repraesentatur, quae aquam salutarem fontis in puteum (puteus) versat. e puteo servus aquam salutarem in amphoram fundit et vetulo, qui in cathedra sedet, apportat. aquarius aquam ex amphora in dolium magnum versat, quod duobus bubus iunctis aliō vehitur. a sinistrā parte et a dextrā superiore in arā Saluti deae sacrificia offeruntur. Salus Umeritana dicitur ab aquā salutaris in Umeris, gente ignotā Hispaniae septentrionalis, e terrā profluente.

Salutares nominantur Castor et Pollux, qui nauis periclitantibus salutem afferunt.



**sarcina** –ae, f. (vel sarcinae –arum, f. pl.)

sarcina est involucrum, fascis rerum utensilium, quem quis umeris portare potest. sarcinae a militibus in baculis portabantur.

Caesar, B. C. 3, 76:

„magna parte impedimentorum et sarcinarum relicta.“

formula dicendi: sarcinis gravare aliquem;

Phaedrus, 2, 7:

„muli gravati sarcinis ibant duo.“



miles sarcinam portans

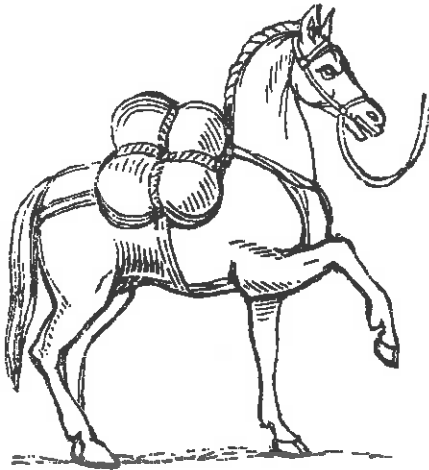

equus sarcinam portans

**sarcophagus** –i, m.

sarcophagus (Gr.), qui carnem comedit, consumit. speciatim dicitur de lapidis seu marmoris genere, in quo corpora defunctorum condita cito ad ossa rediguntur.

Plinius, H. N. 2, 211:

„At circa Asson Troiadis lapis nascitur, quo consumuntur omnia corpora: sarcophagus vocatur.“ sarcophagus pro sepulcro poni consuevit, praesertim eo, in quo cadaver integrum sine rogo (rogus) conditur.

parietes sarcophagorum saepe operibus caelatis ornabant, quae imagines nobis testimonio sunt earum opinionum, quas sibi homines de morte, de vita praeterita et futura finxerunt.

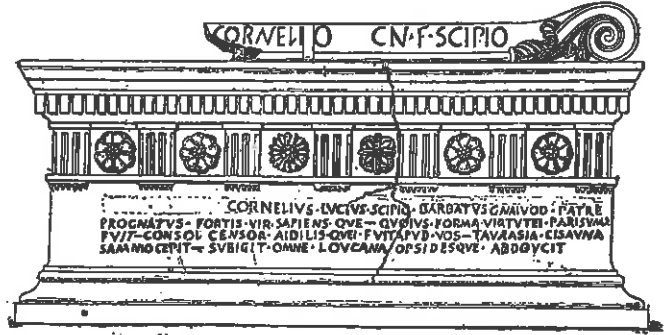

sarcophagus Scipionis Barbati

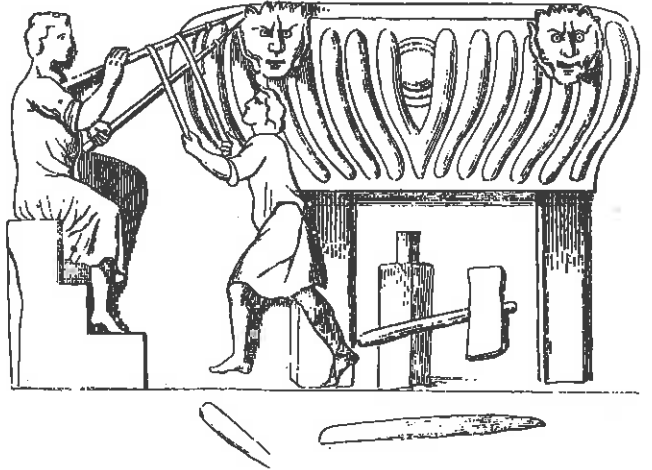

duo sculptores sarcophagum exsculpunt

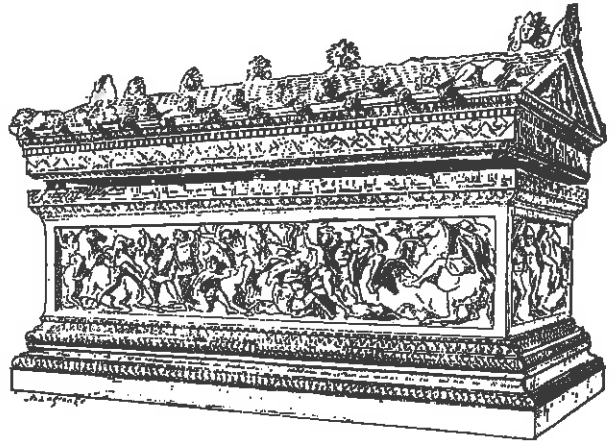

sarcophagus Alexandri Magni qui dicitur

**sarculum** -i, n.

sarculum est instrumentum sariendis agris aptum. sarire = agros malis herbis purgare. rustici primum agros arabant et occabant, deinde sariabant et serebant.

Plautus, Capt. 663:

„semper occant prius quam sariunt rustici.“

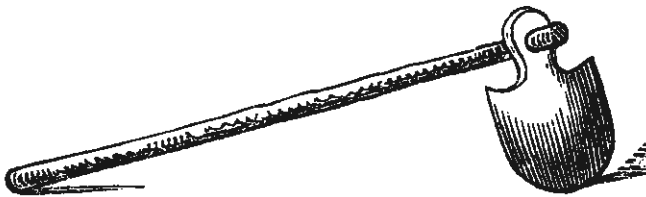

**sartago**-inis, f.

sartago est vas culinarium, in quo cibi friguntur (frigo, frixi, frictum), vel aliud quippiam liquefit aut torretur.



**Saturnalia** n. pl. (gen. -iorum ),

dat. abl. -ibus

Saturnalia erant festa septem dierum in honorem Saturni. celebrabantur mense Decembri. erant autem dies illi pleni laetitiae. his continuatae epulae et commissationes erant; munera ultro citroque mitti remittique solebant a Romanis. domini servis discumbentibus inserviebant; Saturni enim aevo omnia communia fuerunt, nec, quid servitus esset, notum fuit.

**scaenographia** -ae, f.

vel \*\*\*perspectiva. scaenographia est ars pingendi naturali prospectu suo.

Vitruvius, 1, 2, 2:

„scaenographia est frontis et laterum abscedentium adumbratio, ad circinique centrum omnium linearum responsus.“

imagines sumptae sunt ex Arte magna lucis et umbrae Athanasii Kircher, qui his verbis eas explicat: „totum ... hoc quadratum opticum dependet a primā degradatione pavimenti supra cuius parallelas erectae normales dabunt parietum, rerumque erectarum qualiumcumque projectionem (projectio), contignationum vero, porta-

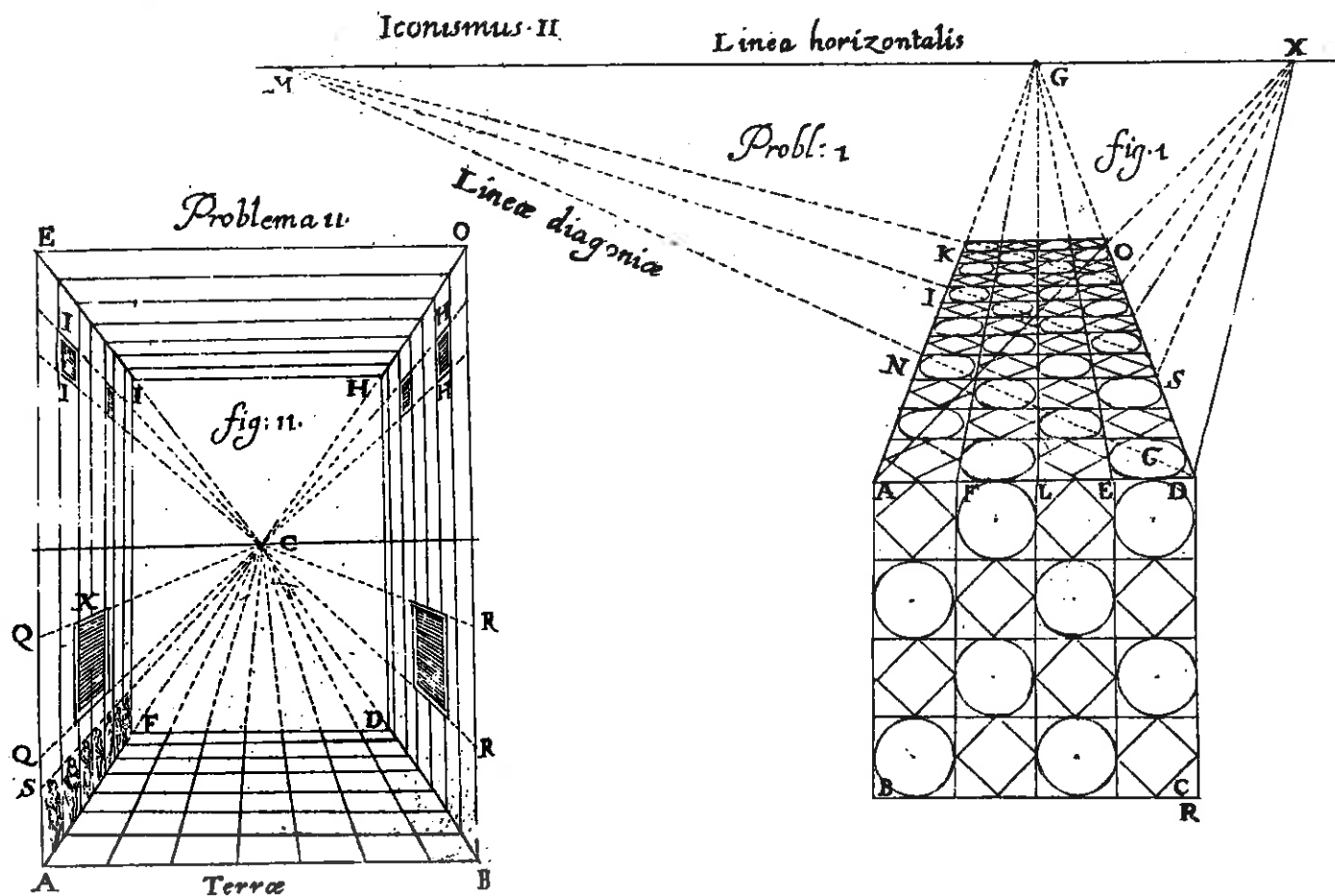



rum, fenestrarum ordine sitarum loxodromius dabunt duo fila ex centro ducta: intra haec enim fenestrae, portae, imagines, sive statuae depictae dabunt projectiones quaesitas.“

**scala** –ae, f. (scalae –arum, f. pl.)

est machina pluribus gradibus constans, qua utimur ad adscendum in superiora.

Caesar, B. C. 1, 28, 4:

„milites positis scalis muros adscendunt.“  
in aedibus plures erant gradus lignei vel lapidei parietibus infixi atque immobiles, ad superiorem contignationem (*contignatio*) ferentes.

Martialis, 1, 117, 7:

„et scalis habito tribus, sed altis.“

h. e. in tertia aedium contignatione, ubi habitare solebant pauperiores.

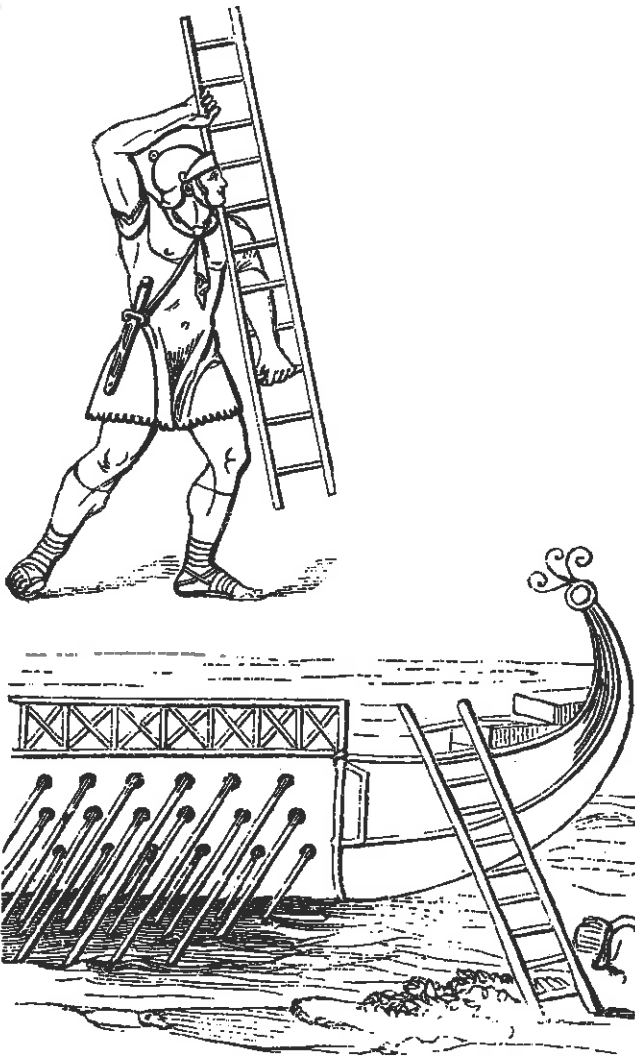

scala, qua navis adscenditur. navis triremis est, i. e. tres ordines remorum habet. sunt etiam naves quadrirèmes quattuor ordinibus remorum praeditae.

**scalprum** –i, n.

est ferramentum, quo aliquid inciditur. varii hoc scalpro *artifices* utuntur, ut sutores, lapicidae, agricolae, chirurgi. deminutivum: scalpellum.

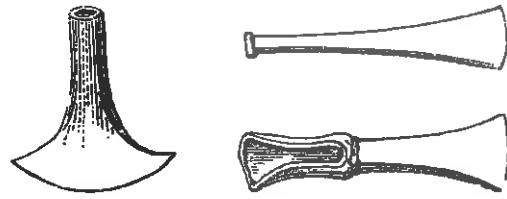

**scamnum** –i, n.

est gradus ligneus, qui lecto apponitur scandendi causā; aut fulciendorum pedum, dum sedēmus. deminutivum: scabellum.



scabellum

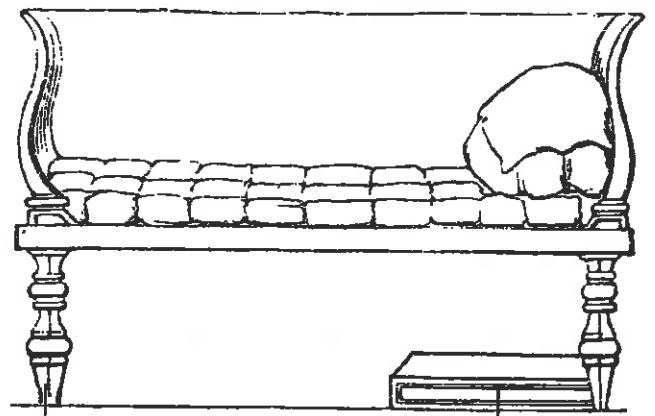

lectus

scamnum

## scapha —ae, f.

scapha est exigua navicula, quales sunt, quae in maioribus circumvehuntur, vel eas pone sequuntur; item quibus utimur ad piscandum.

\*\*\*scapha complicabilis, constat ex harundinibus et involucro impermeabili. harundines asportandi causā in parvas partes disiungi possunt.

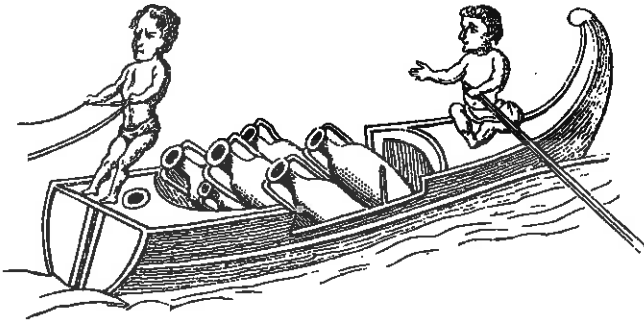

## scarabaeus —i, m.

est insecti genus tenues habens et fragiles pennas, et ob id crustā superveniente tectas.

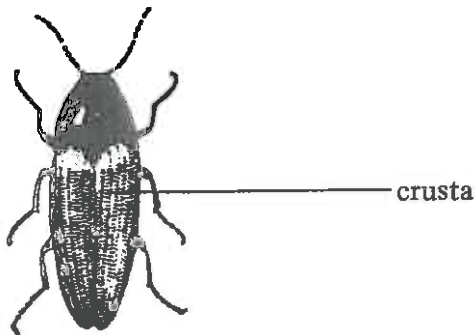

## sceptra —i, n.

sceptra bacula sunt, *signa* potestatis regum, ex ebore facta: sceptra eburnea. sceptra imperatoris *aquilā* ornata sunt.



sceptra Augusti



Porsennae, regis Etrusci, sceptrum

## scirpea —ae, f. / vel sirpea —ae, f.

est corbis ampla ex viminibus facta, quae plastro (*plastrum*) imponitur vehendo stercore. Varro, L. L. 5, 139 Müll.:

„sirpea, quae virgis sirpatur, id est colligando implicatur, in qua stercore aliudve quid vehitur.“  
scirpus idem est quod iuncus; in palustribus locis nascitur.

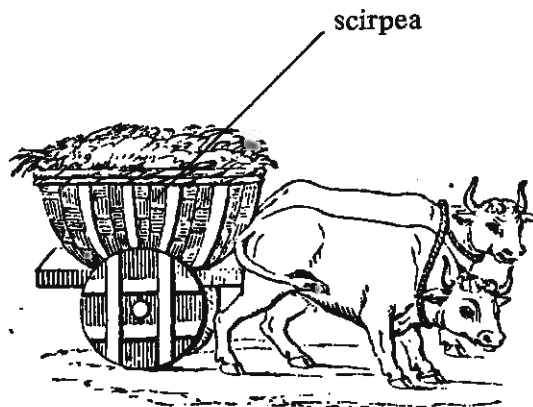

scirpea

## scopa —ae, f. (vel scopae —arum, f. pl.)

scopae ex multis virgis constant et sunt instrumentum quo verrimus et sordes cumulando purgamus.

proverbium: „scopas dissolvere“ = rem aliquam inutilem reddere.

Cicero, Orat. 71, 235:

„isti autem, cum dissolvunt orationem, in qua nec res, nec verbum ullum est, nisi abiectum, non clipeum, sed ut in proverbio est (etsi humiliter dictum est, consimile est), scopas, ut ita dicam, mihi videntur dissolvere.“  
 „scopae solutae“ etiam de homine nihili dicitur.

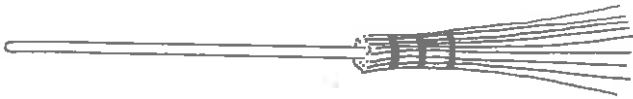

### scytala —ae, f.

(Gr.) est genus epistolae secretioris apud Lacones (et postea etiam apud Romanos), quam scribebant in membrana, vel loro, super surculum spirae modo extento, deinde evolutum lorum mittebant ad eum, qui conscius erat: a quo rursus circa parem surculum circumvolvebatur, apparebantque verba prius descripta, quae parem surculum non habenti fieri nullo modo poterat, ut legerentur.

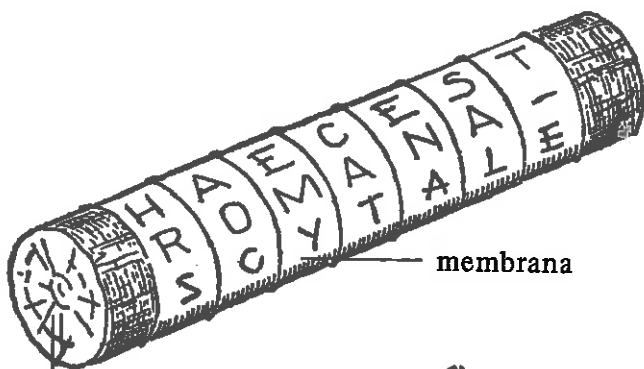

surculus



cursor

### sectio conica

conus, qui plano variā positione secatur has lineas curvas efficit: circulum, si planum parallelum est basi, parabolam, si planum conum secat parallelum rectae laterali AC, hyperbolam, si planum etiam conum superiorem secat, ellipsin si planum minorem angulum facit quam est angulus inter BCA.

imagines sumptae ex Arte magna lucis et umbrae Athanasii Kircher.

Conus

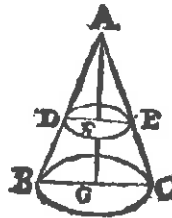

Parabola.

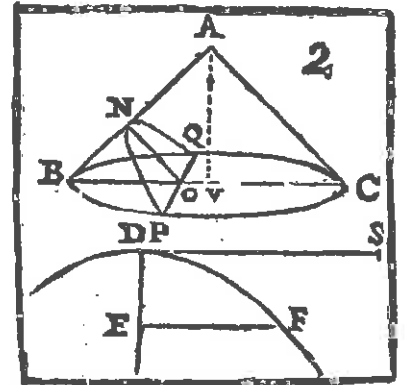

Hyperbola.

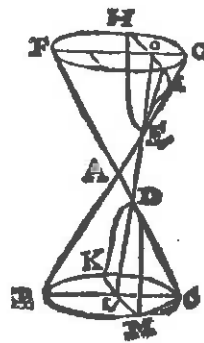

Ellipsis.

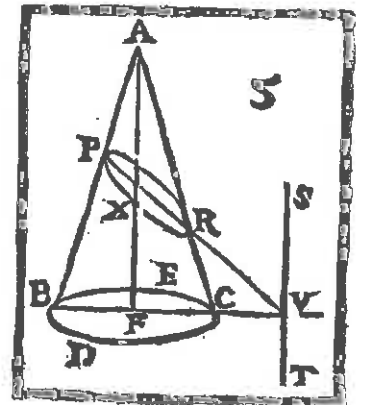

### securis —is, (—i, —im) f.

securis est ferramentum lata acie cuius usus est lignis caedendis, cervici amputandae et in re sacra sacrificiis faciendis (*sacrificium*). si utrimque acuta est, bipennis (*penna*) dicitur.

Ovidius, Fast. 4, 649:

„silva vetus nullaque diu violata securi“ (*fascis*).



miles Romanus  
securi armatus

### sensus —ūs, m.

sensus est actus sentiendi. sunt quinque sensūs in animalibus: auditus (—ūs, m.), visus (—ūs, m.), olfactus (—ūs, m.), gustus (—ūs, m.) et tactus (—ūs, m.).

„anima sapit ac meminit in cerebro, irascitur in corde, concupiscit in hepate, audit in auribus, cernit in oculis, olfacit in naribus, gustat in palato et lingua, sentit in omnibus partibus corporis.“ (Erasmus).

palatum, cerebrum: cf. —os, oris, n.

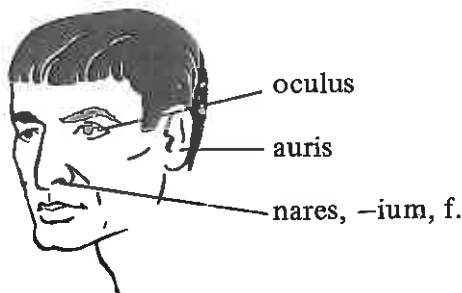

### septentriones —um, m. pl.

sunt septem stellae, quae Ursam maiorem vel Arctum (—us, f.) conficiunt. si recta linea a sexta ad septimam stellam quinques producitur, invenitur stella polaris ad quam axis terrae vergit.

adiectiva: septentrionalis, —e, arcticus / antarcticus.

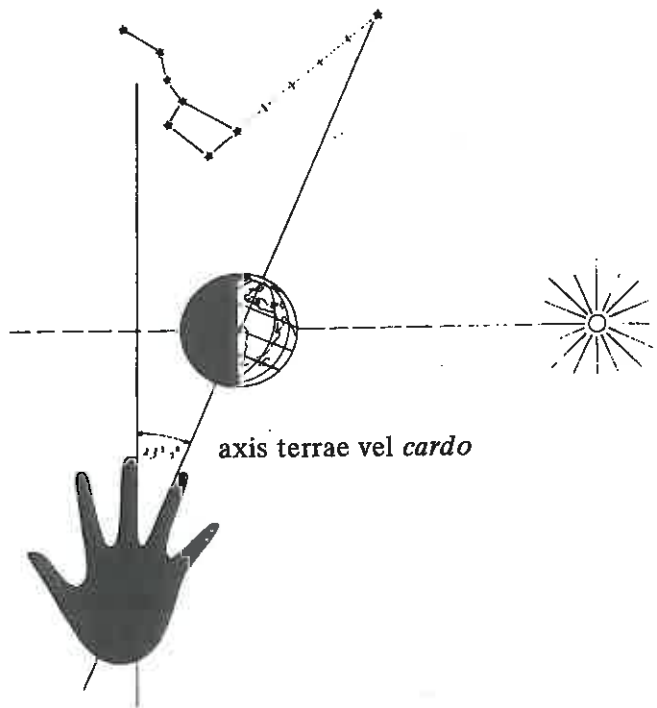

### Septimontium —i, n.

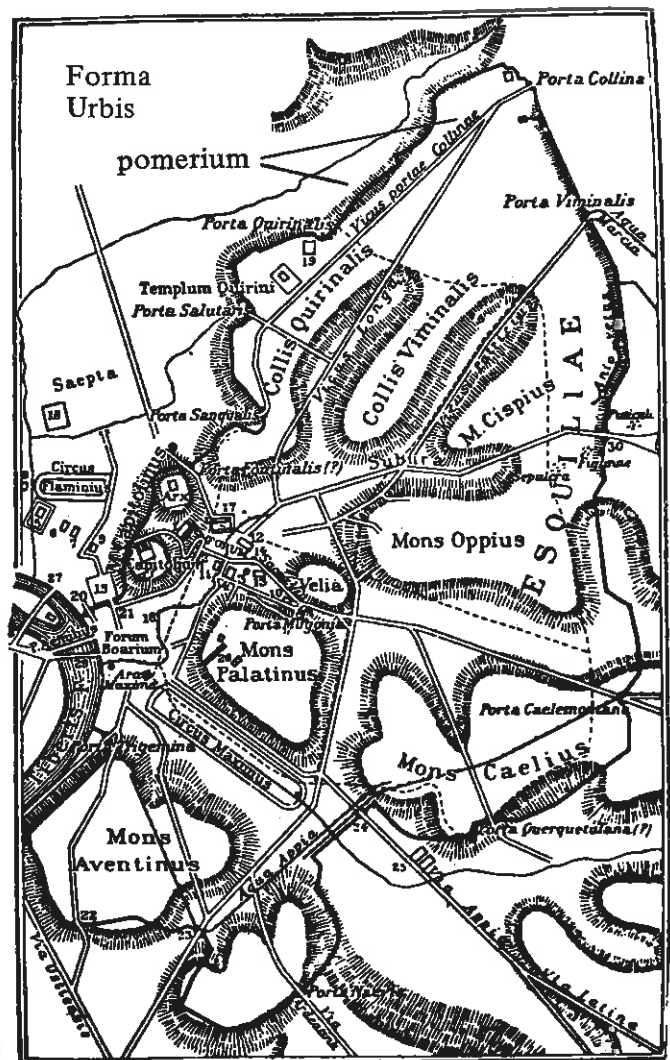

est dies festus, undecimo die mensis Decembris in honorem septem montium aut collium primitivae urbis Romanae celebratus. septem colles aut montes sunt:

Mons Capitolinus (Capitolium)

Mons Palatinus (Palatium)

Mons Aventinus

Mons Caelius

Mons Esquilinus

Collis Viminalis

Collis Quirinalis.

hi septem montes moenibus Servianis saepti erant (in Forma Urbis lineā indicantur moenia Serviana).

sunt alii colles et montes, ut Mons Vaticanus, Mons Marius trans Tiberim siti, qui non inter septem montes antiquae Urbis numerantur.

### sepulcrum -i, n.

est locus, in quo mortuus sepultus est, vel locus, ubi corpus ossave hominis mortui condita sunt.

titulus sepulcralis Treveris inventus haec dicit: HIC REQUIESCIT IN PACE AGRICI / US QUI VIXIT ANNOS III M(enses) III D(ies) III / SYRICA MATER ET EUONYMA / SOROR TITULUM PRO CARITATE / POSUERUNT. inscriptio christiana est, nam dicitur „in pace“ et monogramma Christi et columbae symbola sunt Christianae fidei. monogramma Christi con-

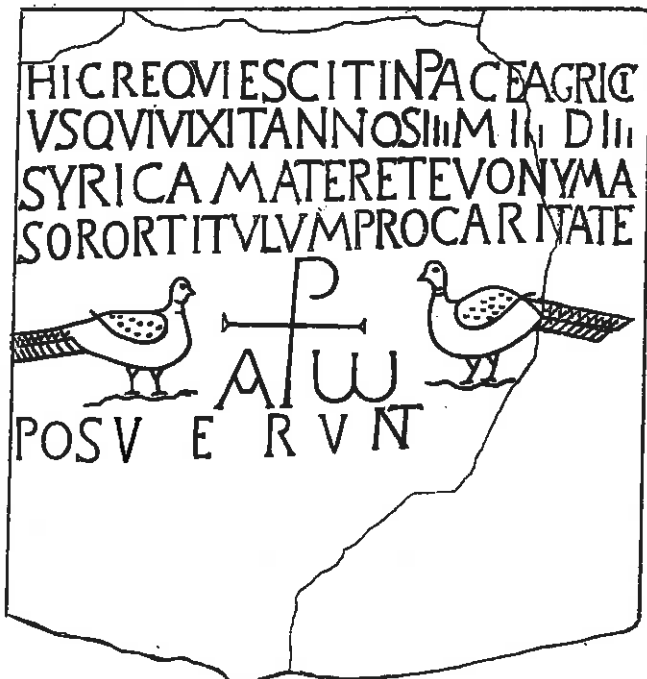

stat e duabus litteris Graecis X et P, quae unum signum  $\chi$  faciunt. A initium,  $\omega$  autem finem significat.

### sera -ae, f.

sera est repagulum, fustis, qui opponitur clausis foribus.

Varro, L. L. 7, 108:

„serae, quibus remotis, fores panduntur.“

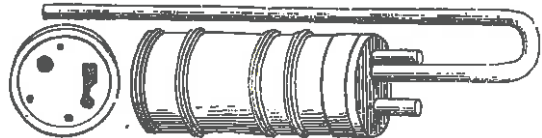

### serra -ae, f.

serra est instrumentum tignarii (*tignarius*) cuius lamina dentibus acutis praedita dissecandis materiae et tignis inservit.

propter similitudinem interdum montes cacuminibus acutis „serrae“ dicuntur (cf. Hispanice „sierra“).

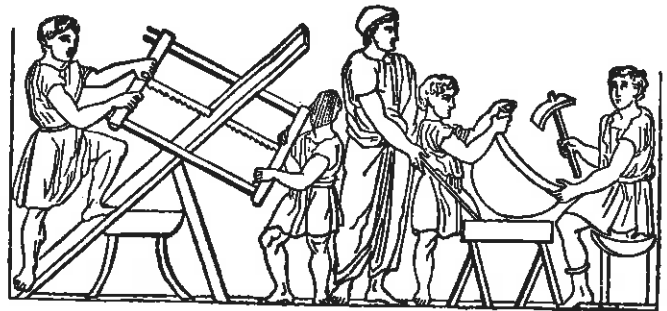

### Sibylla -ae, f.

Sibylla est virgo fatidica, *vates*. nonnulli duas, tres, quattuor, quinque (Pausanias), decem (Varro) fuisse dicunt. apud scriptores nominantur Libyca, Persica, Cimmeria aliaeque, sed ex his nobiliores habentur Sibylla Delphica et Erythraea. Cumana vel Cumaea Amalthea nuncupatur.



libri Sibyllini Sibyllae Cumanae libri fatidici erant, qui a Romanis occulebantur, nec eos ab ullo, nisi a quindecimviris inspicere fas erat, quia credebantur continere omnia, quae Romanis evenirent.

Amalthea Sibylla libros attulisse dicitur ad regem Tarquinium Priscum et pro eis trecentos aureos postulavisse; cum rex aspernatus esset pretii magnitudinem et derisisset mulieris insaniam, illa in conspectu regis tres libros combussit ac pro reliquis idem pretium postulavit. Tarquinius multo magis mulierem insanire ratus est, denuo tribus aliis libris exustis, cum in eodem pretio perseveraret, motus est rex ac reliquos trecentis aureis emit. Lactantius, apud Gellium, 1, 19, 11:

„ad eos, quasi ad *oraculum*, quindecimviri adveniunt, cum di immortales publice consulendi sunt.“ *xylographia* sumpta est ex opere Bocacii, „De claris mulieribus“ primum typis aeneis (*typus*) impresso et xylographiis ornato in aedibus Iohannis Zainer, Ulmae, anno 1473 post Christum natum.

**signifer** —i, m.

signifer in re militari est is, qui in exercitu *signum* seu *vexillum* fert.



imago signiferi in columna Traiani

**signum / sigillum, -i, n.**

sigillum est imaguncula, parvum *signum* vel *statua*. sigillum etiam est imago, quae anulo signatorio in cera aliave materia imprimitur, ob signandis litteris, amphoris (*amphora*), scriniis. verbum: sigillo 1 = signo vel sigillo instruere, munire.

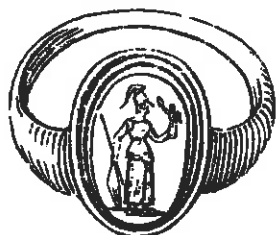

anulus signatorius

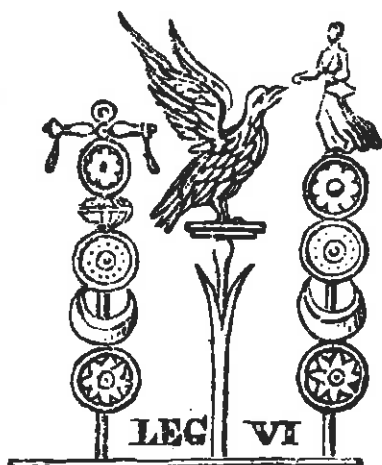

signa militaria

**silex -icis, m.**

est lapis durus, sectilis, cui scintillae ignis excuduntur. viae publicae silicibus stratae sunt, ut apud Livium, 41, 27, 7: „clivum Capitolinum silice sternendum curaverunt.“

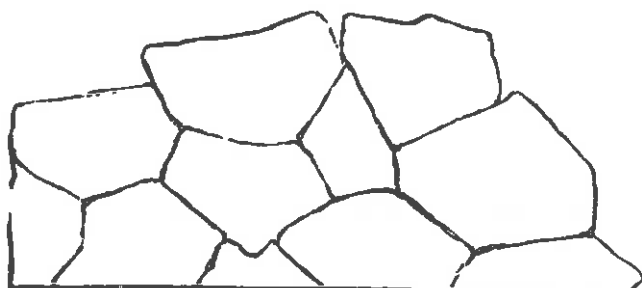

via silicibus strata

**silicernium -i, n.**

est cena funebris, quam alio nomine scriptores exsequium vocant. proprie silicernium est convivium funebre (*funus*), quod senibus exhibetur.



silicernium in sepulcro Romano

**simpulum -i, n.**

est vas parvum, quo vinum in sacrificio libatur.



simpulum

cyathus

imago repraesentat sacerdotem, quae simpulo vinum ex amphora haurit.

## sinus —us, m.

a) sinus dicitur de curvatura, flexu et cavitate cuiuscumque rei.

Columella, r. r. 4, 25, 1:

pars falcis (falx), quae flectitur, sinus nominatur.

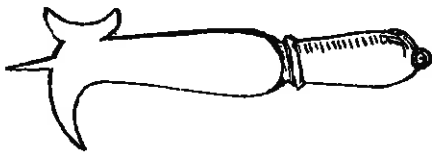

falx

b) de veste ampla eiusque plicaturis.

Livius, 21, 18:

„tum Romanus sinu e toga facto, hīc, inquit, vobis bellum et pacem portamus.“



c) sinus est in ora maris terra curvata ac recedens, et ipsae terrae circa sinum iacentes.

d) sinus in re mathematica: non nisi nomen commune habet cum prioribus usibus, nam ex erronea translatione vocis Arabicae provenit.

## Sirenes Sirenum, f. pl., vel Sirenae —arum

Sirenes sunt maris monstra superiore parte virginis alatae formam habentia, inferiorem volucris.

navigantibus cantu Sirenum deceptis naufragium paratur.

tres Sirenes fuisse dicuntur, Acheloi fluminis et Calliopes vel Terpsichores vel Melpomenes Musae filiae.

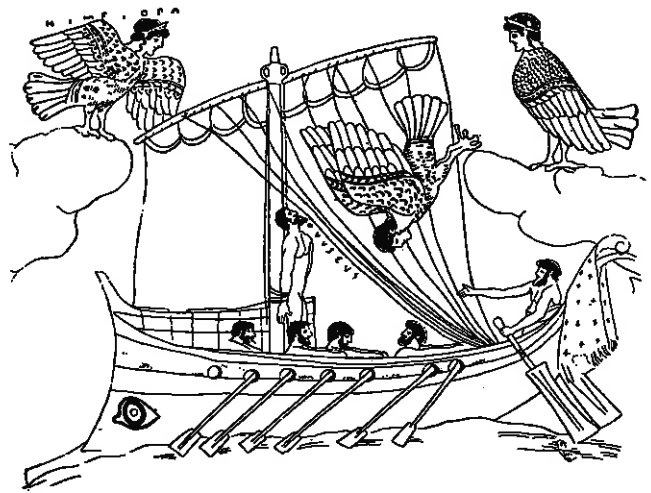

in imagine Ulixes malo navis affixus cantum Sirenum auscultat, remigum autem aures cera obstructae sunt, ne ab eis decipiantur.

## sistrum —i, n.

est *crepitaculum* aeneum, quo Aegyptii sacerdotes in Isidis sacris uti solebant.

sistrum apud Aegyptios vicem tubae (*instrumenta musica*) exhibebat.



sacerdos Isidis, dextrā sistrum agitans

## situla —ae, f.

est vas ad aquam hauriendam, urna, hydria; inferior pars acuta est, ut melius in aquam putei (*puteus*) mergatur.

Anthologia Lat. 65. 3 M.:

„extractam puteo situlam cum ponit in horto.“  
situla et deminutivum *sitella* dicitur urna, unde educuntur sortes: in situla aqua plena semper una sors summa est.



Plautus, Cas. 358/59:

„... adsunt quae imperavisti, omnia:  
uxor, sortes, situla, atque egomet...“

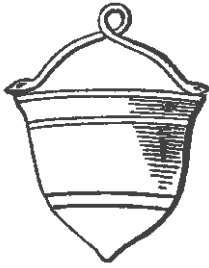

situla

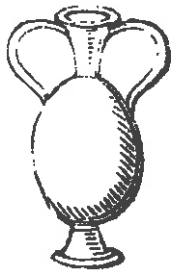

sitella

### solarium –ii, n.

a) *horologium* solare = solarium

b) solarium est locus editus supra domum, lithostrato pavimento (*pavimentum*) tectus, soli expositus ad apricandum idoneus.

Plautus, Mil. glor. 378s:

„... neque solarium est apud nos, neque hortus ullus,  
neque fenestra nisi clathrata.“

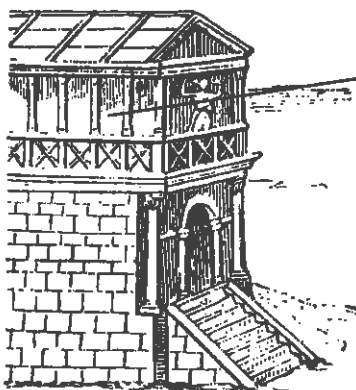

solarium

### solea –ae, f.

est genus plani calceamenti, quo solum pedis tantummodo subtegitur, ansulis in superiore parte coeuntibus revinctum (*vestimenta*). communes erant soleae viris ac feminis, sed viri eisdem domi, foris calceis utebantur. soleatum enim prodire aliquem molle erat et indecorum et turpe.

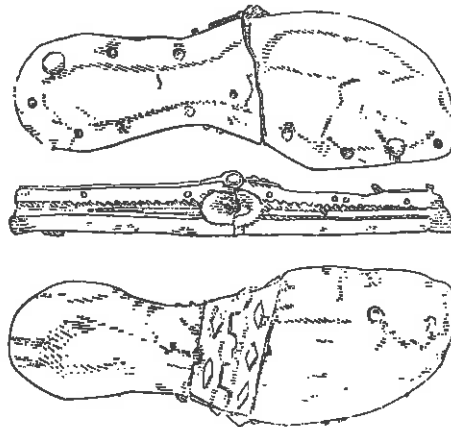
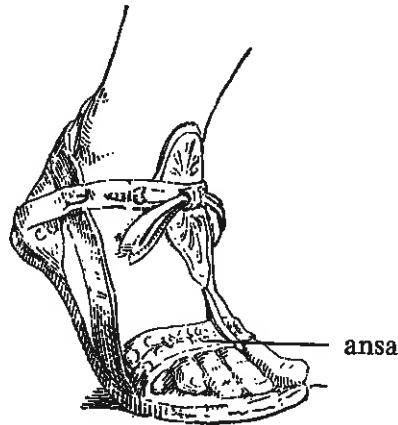

Lappones soleis oblongis in venationem prodeuntes. imago sumpta ex opere Olai Magni, 1555 conscripto

## solium —i, n.

a) est sella regalis, thronus; sella deorum.

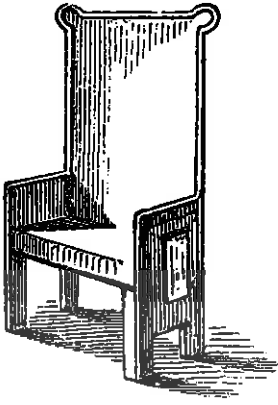

Servius, ad Aen. 1, 506:  
„solium proprie est armarium uno ligno factum,  
in quo reges sedebant propter tutelam corporis  
sui ...“

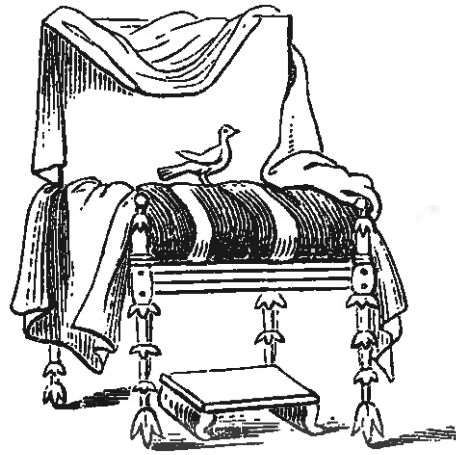

Vergilius, Aen. 10, 116:

„solio tum Iuppiter aureo  
surgit ...“

b) solium etiam dicitur de sella concava, labro  
(labrum), alveo in balineis (balneum).

## solstitium —i, n.

est tempus illud, quo sol stare videtur aliquan-  
tisper, tum quando signum Cancris ingreditur  
Iunio mense, tum quando signum Capricorni  
mense Decembri: illud est solstitium aestivum,  
quo sol incipit a nobis recedere, hoc solstitium  
hibernum, quo ad nos accedere. solstitium  
hibernum etiam bruma (= brevissima sc. dies)  
nominatur (zodiacus).

aequinoctium, —i, n.

est tempus illud, quo dies et noctes horarum  
spatio aequales sunt. Duo autem sunt aequi-  
noctia: aequinoctium vernalis, circa VIII. Ca-

lendas Apriles et in signo Arietis conficitur;  
autumnale X. Calendas Octobres in signo  
Librae.

Varro, L. L. 6, 8:

„cum (sol) venit in medium spatium inter bru-  
mam et solstitium, quod dies aequus fit ac nox,  
aequinoctium dictum.“

Columella, r. r. 11, 2, 31:

cum ab aequinoctio verno in Cancrum sol  
meat, omnes dies maiores sunt noctibus suis;  
item ab autumnali aequinoctio usque ad bru-  
mam minores dies noctibus dilatatis.

cursus solis

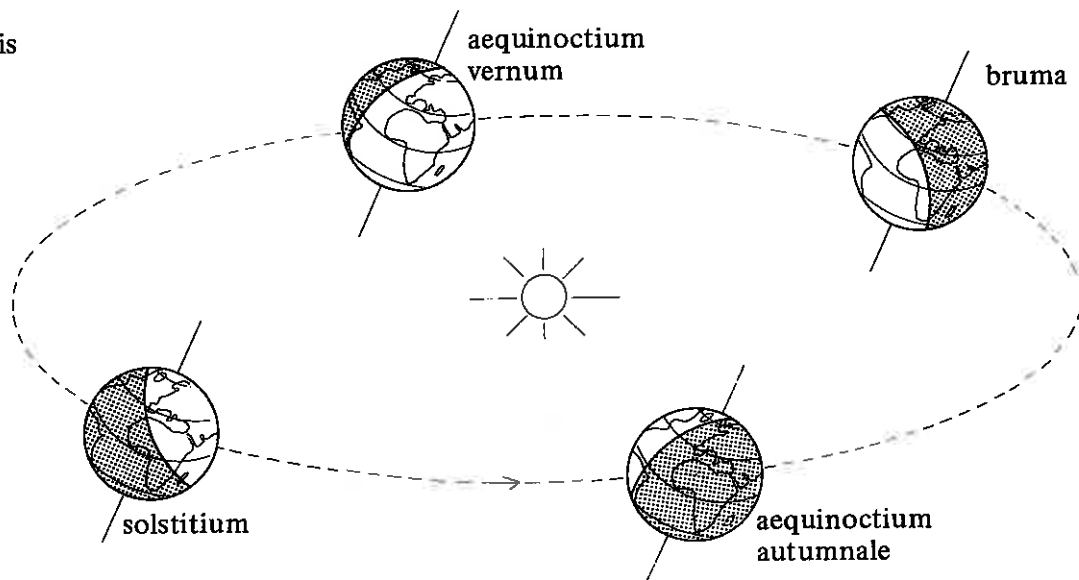

## speculum —i, n.

est instrumentum ex vitro, chalybe, argento, stanno et similibus, in quo imaginem nostram videmus:

translate: Hieronimus, Ep. 54, 13:

„speculum mentis est facies, et taciti oculi mentis fatentur arcana.“

Paulus, ad Cor. 1, 13, 12:

„videmus nunc per speculum in aenigmate; tunc autem facie ad faciem.“



speculum Etruscum  
e stanno factum

## sphaeristerium —i, n.

est locus pilae lusui destinatus, a Gr. sphairizo = pilā ludo. erant sphaeristeria cubicula in baineis (*balneum*), in quibus se tum aliis rebus, tum pilae (*pila*) ludo exercebant.

titulus Aventici inventus:

TI. CLAUDIUS TI. FIL(IUS) / MATERNUS  
AEDILIS SPHAERISTERIUM D(E) S(UO)  
D(EDIT)

## spica —ae, f.

est acies, cacumen; sed speciatim occurrit et est collectio plurium granorum in summo culmo frumenti, hordei et huiusmodi. (*tribulum*)

Varro, r. r. 1, 48, 1:

„spica ea, quae mutilata non est, in hordeo et tritico tria habet continentia, granum, glumam, aristam: et etiam primitus spica cum oritur, vaginam.“

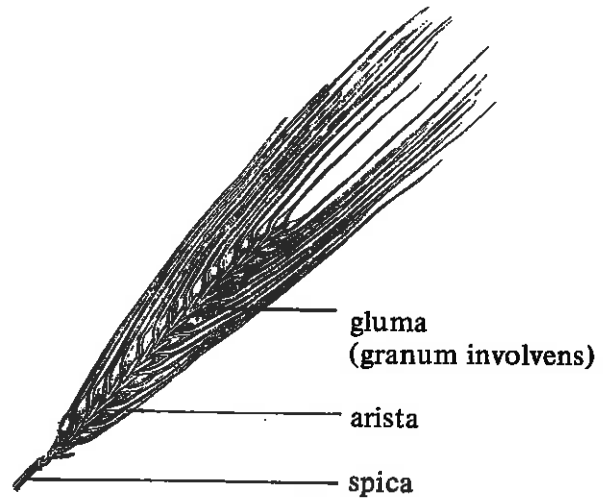

## spina —ae, f.

spina generatim est id, quod acutum est, aculeus.

a) in re anatomica spina est vertebrarum series in dorso animalium, a collo ad extremum usque os (*os, ossis*).

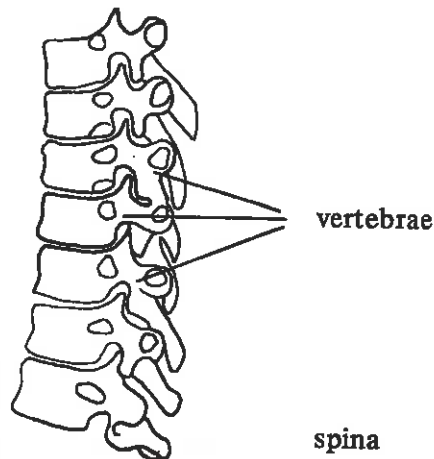

b) spina etiam nominatur medius circi (*circus*) tractus, ubi *obelisci*, simulacra deorum et alia huiusmodi erant.

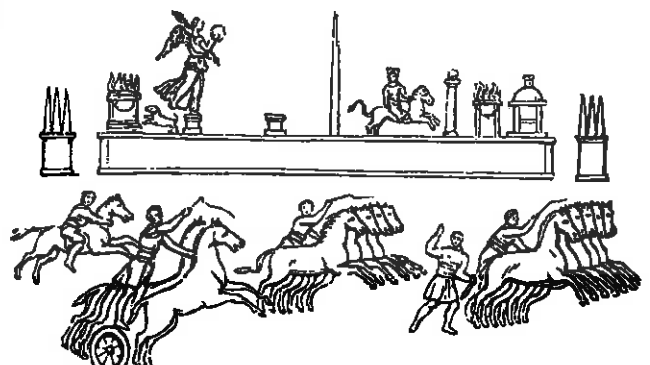

## sponda –ae, f.

est exterior lecti (*lectus*) aut grabati tabula aut tigillum, cui adnectuntur restes, quibus culcita sustinetur.

culcita est id, super quod dormientes quiescimus, non id, quo integimur.

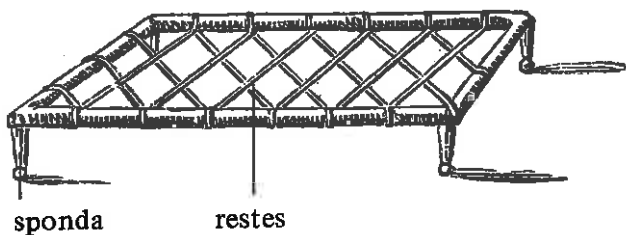

## spongia –ae, f.

spongia est molle corpus, rarum et fistulosum, medium inter animal et plantam, et utriusque naturae particeps. nascitur in marinis petris aliturque conchis, pisce, limo. varius est spongiarum usus: usurpantur tergendis mensis et pavimentis, exhauriendis siccandisque liquoribus; imbibunt enim facile, nec reddunt nisi comprimantur.

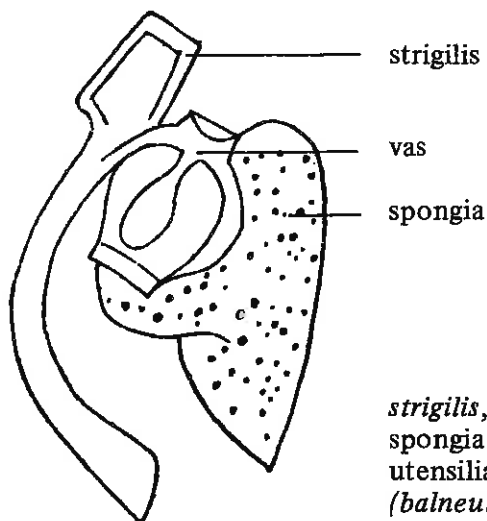

*strigilis*, vas et spongia = balnei utensilia (*balneum*)

## sponsus, sponsa

ptc. verbi spondeo, sponendi, sponsum. verbum usum habet in contractibus, pactis, sponsionibus, stipulationibus, cum quis se daturum quippiam aut facturum pollicetur vel pro altero se obligat.

sponsa, –ae, f.

est mulier alicui promissa in matrimonium, pacta, sperata et nondum uxor.

sponsus, –i, m.

est qui desponsus est, nondum maritus.

sponsalia, –ium, n. pl.

apud Latinos per stipulationem contrahebantur, id est per interrogationem et promissionem factas inter eum, qui daturus erat aliquam mulierem in uxorem, et inter eum, qui accepturus. in his sponsalibus statuebatur etiam dos, die matrimonii aut tribus pensionibus solvenda.



sponsus et sponsa

## sporta –ae, f.

sporta est vas, *corbis* simile, e vimine aut iunco aut sparto aliave levioere materia, ad varios usus. deminutivus: sportula, sportella.

Martialis, 10, 37, 17:

„dum loquor, ecce redit sportā piscator inani.“  
sportulae etiam sunt nummorum receptacula.



## squama –ae, f.

a) squama est dura cartilago, quae piscibus et anguibus pro cute est.

b) dicitur de anulis et catenulis squamae similibus in lorica. squamatus est squamis inductus.

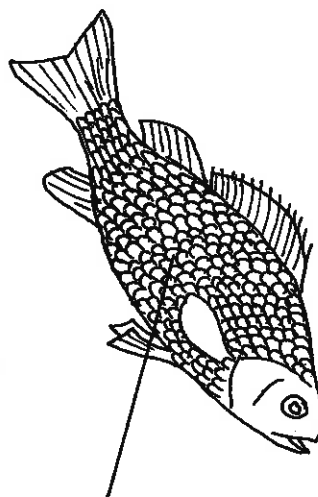

squamae piscis



lorica squamata

stabulum —i, n.

est statio, sedes, habitatio, locus, et saepe est locus, ubi iumenta et pecora aliaeque bestiae degunt.

equile, —is, n. est stabulum equorum,  
bovile stabulum boum.

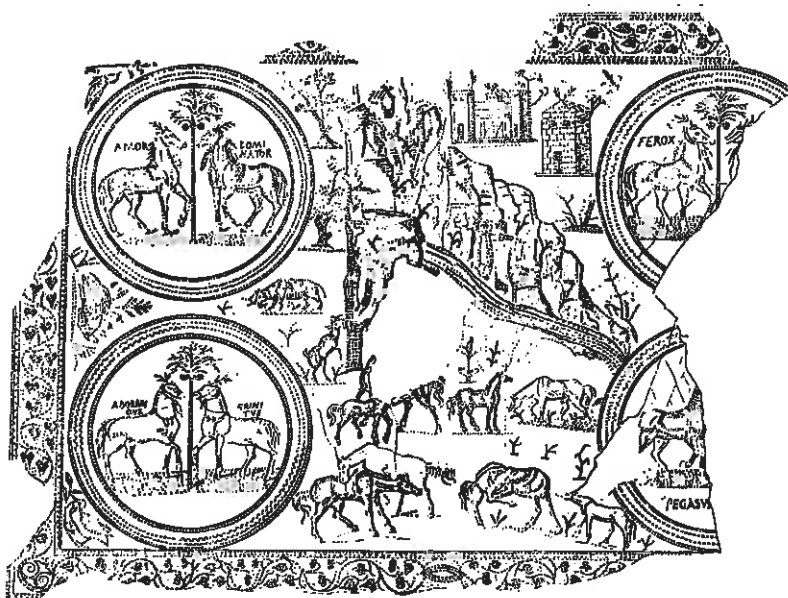
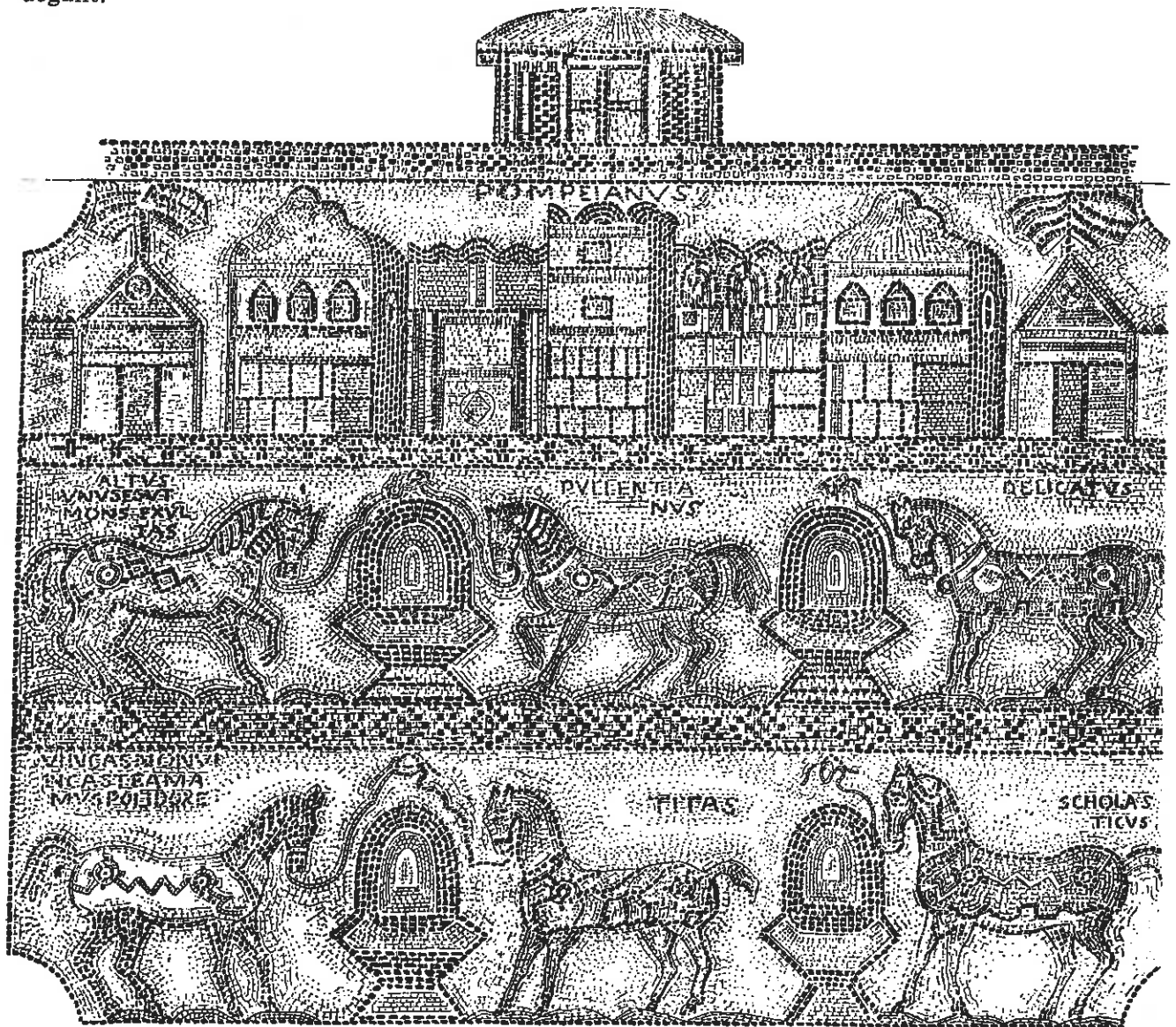

hae duo opera tessellata Africae Septentrionalis e villis rusticis Romanis. primum stabulum equorum (equile) monstrat. equi ante *patenas* (*praesepia*) stant; nomina eorum indicantur, ut etiam in secunda imagine, ubi stabulum et cohors equorum depicta sunt.

## statēra —ae, f.

est instrumentum, quo res sine lancibus ponderatur.

statera differt autem a trutina, ut species a genere. duae enim species trutinæ sunt:

- a) libra, quae binas habet lances;
- b) statera, quae scapo constat punctis distincto, quae pondera discriminant.

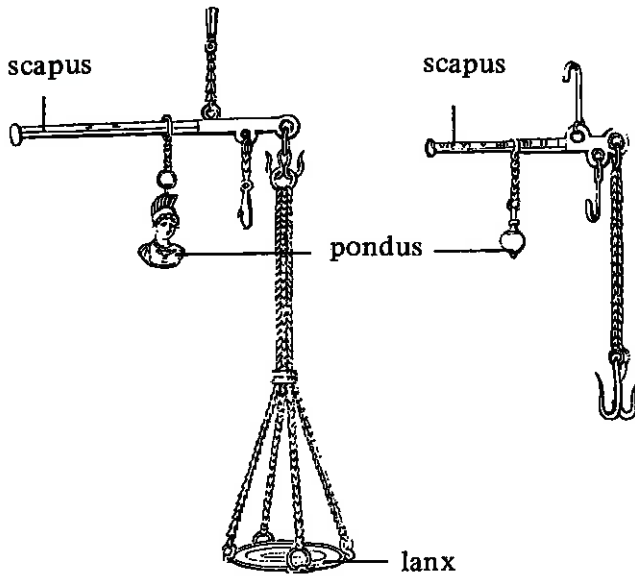

## statua —ae, f.

id quod statuitur, quod erectum stat arte elaboratum, speciatim est *signum*, simulacrum, ex aere aliove metallo, e lapide aut ligno, imaginem (*imago*) referens cuiuspiam, honoris et memoriae causā, vel columella, *pila*.



statua Atlantis umeris aedificium sustentis

## stillicidium —i, n.

a) stillicidium est umor stillatim cadens et ipse casus umoris stillatim cadentis. saepe dicitur de casu aquae pluviae ex tectis vel ex proiecturis tectorum stillatim defluentis.

b) stillicidia dicuntur etiam loci in tectis, e quibus aqua pluviae stillatim decedit. (*tegula*)

## strenae —arum, f. pl.

strena dictum est munus, quod dabatur die festo et fere anni initio, boni omnis gratiā. (strenae = francogallice „les étrennes“)



in *lucernā* fictili Victoria votum in annum novum apportat cum strenis. *Ianus* biceps in nummo mensem Ianuarium, initium anni, significat



nummus Commodo imperatori dedicatus. in margine haec leguntur: „Felici imperatori Annum novum faustum felicem“ (omino). strenae sunt fructūs, nummi (1) mar-supium (2) plenum aliaque

## strigilis —is, f.

strigilis est instrumentum serratum (*tignarius*), curvum, manubrio et canaliculo instructum, quo utebantur praecipue in balneis (*balneum*) ad destringendam cutem, abradendas sordes et sudorem detergendum. (*spongia*)

**structor** –is, m.

structor a) est faber muralis, *architectus*.  
b) dicitur etiam de eo, qui convivium curat,  
*fercula* docte disponit et mensam exstruit, cibos  
carpit. (*convivium*)

Petronius, sat. 35:

„rotundum enim repositorium duodecim habe-  
bat signa (*zodiacus*) in orbe disposita, super  
quae proprium convenientem materiae structor  
imposuerat cibum: super Arietem cicer arieti-  
num, super Taurum bubulae frustum ...“



**sublica** –ae, f.

est trabs praelonga, humi statuta et erecta ad  
quippiam sustinendum, pertica, palus.  
speciatim dicitur de trabibus, quae in alveo  
fluminis defixae pontem sustinent ut in hoc

ponte in Rheno a Caesare facto aut ut in pri-  
mo ponte Romae in Tiberi facto, qui ideo pons  
sublicius nominabatur. (*pons*)

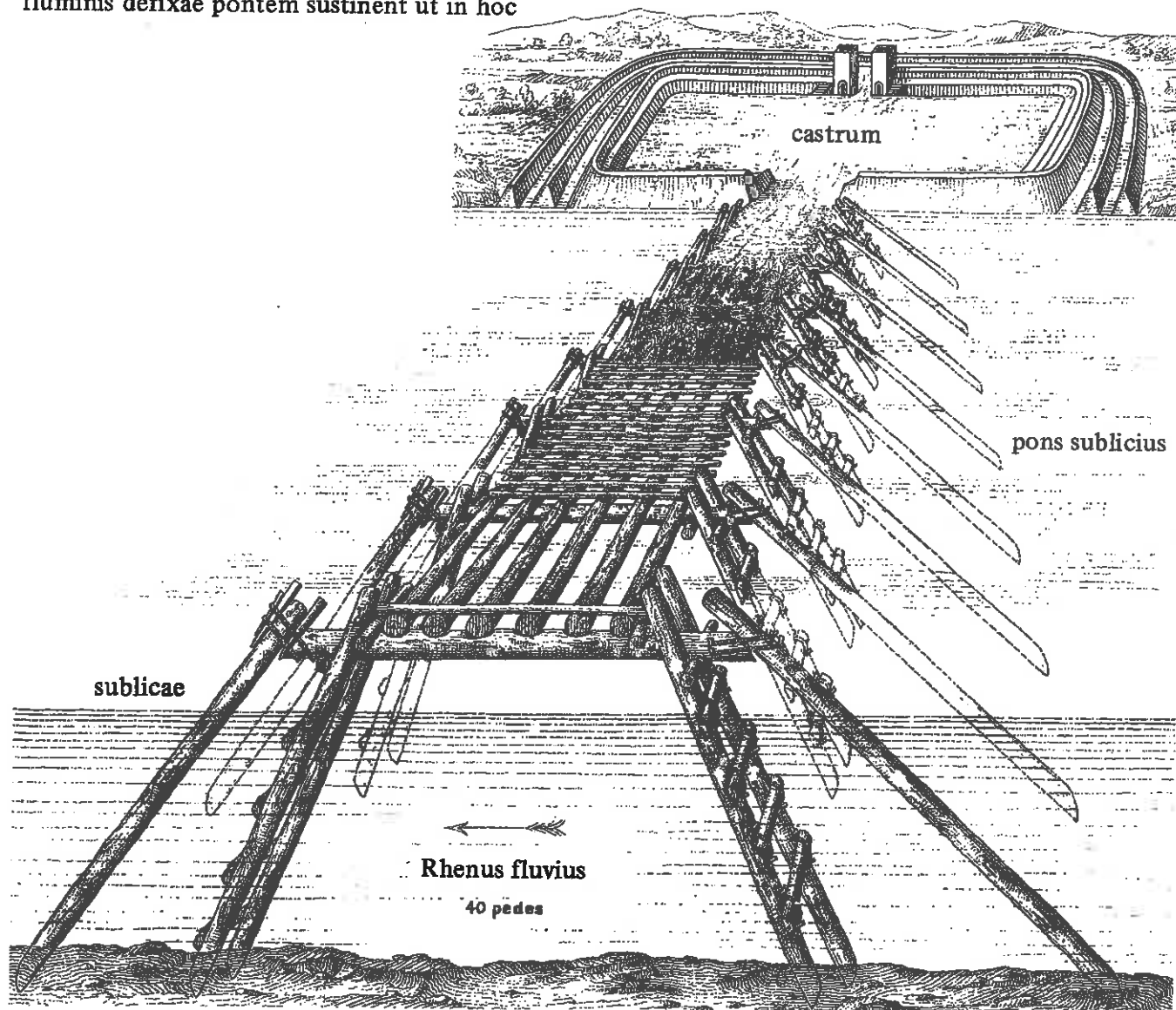

## suburbium —i, n.

suburbium sunt frequentes extra urbem domus instar vici urbani aedificatae.

adi. suburbanus, —a, —um = sub urbe positus, urbi vicinus.

Cornelius Nepos, Att. 14, 3, de Attico, Ciceronis amico:

„nullos habuit hortos, nullam suburbanam aut maritimam sumptuosam villam, neque in Italia, praeter Arretinum et Nomentanum, rusticum praedium.“

Suburbana Italia est ea pars Italiae, quae vicina est Romae.

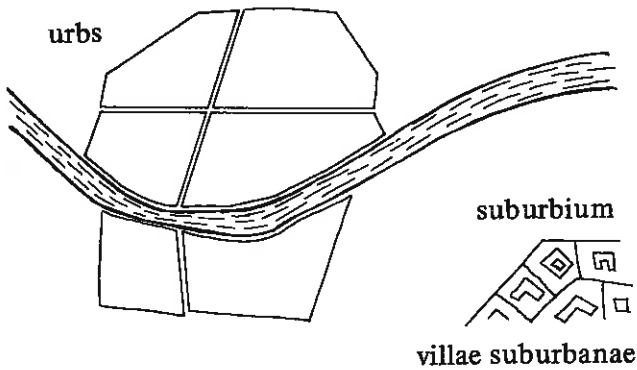

## sufflumen —inis, n.

est lignum illud vel vinculum, quo per radios rotarum (*rota*) traiecto, vel potius ferreum in-

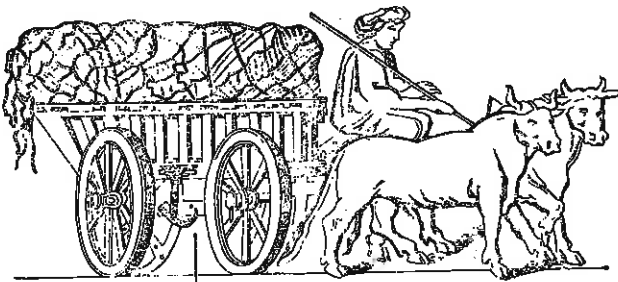

sufflumen

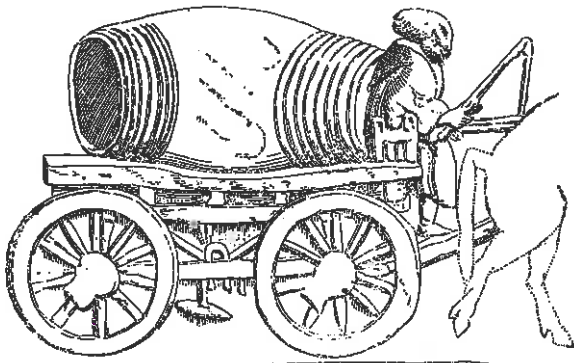

in prima imagine in villa rustica Helvetica prope Urbam inventā pendet de rhaeda sufflumen ante posteriorem rotam

strumentum, quo subter rotae unius canthum (canthus) supposito, currūs in declivibus locis nimio impetu ruentes cohibentur.

## sulcus —i, m.

sulcus est vestigium aratri (*aratrum*), fossula in longum vomere impresso ducta.

formulae: sulcos ducere, sulcos agere.

Festus, p. 302, 4 M.:

„sulci appellantur, qua aratrum ducitur vel sationis faciendae causā vel urbis condendae.“

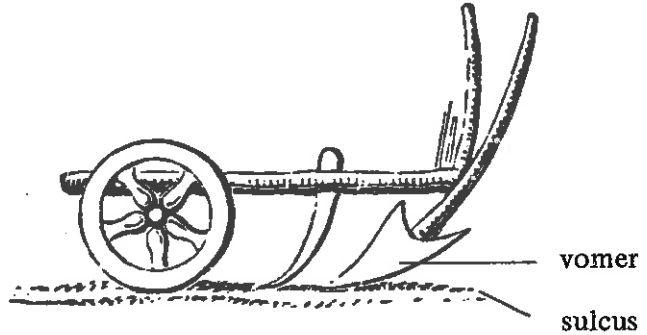

vomer

sulcus

## suovetaurilia —ium, n. pl.

sunt sacrificium suis, ovis et tauri, quod usurpabatur in lustrationibus agrorum, populi, exercitus et huiusmodi.



nostra imago suovetaurilia in lustratione exercitūs habita monstrat. dextrā est sus (1), sinistrā aries (ovis) (2) et taurus (3). imperator (4) tus in flammās coniicit. legionarii adstantes signa militaria (5) et vexilla (6) portant, duo tubā (7) canunt



**supellex** —lectilis, f.

vasa et instrumenta cuiuscumque generis supellectiles sunt, ut in hac imagine culinae (*culina*) supellectiles Coloniae Agrippinae inventae.



amphora

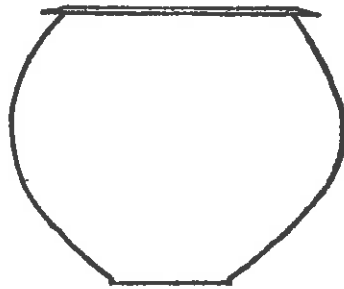

dolium

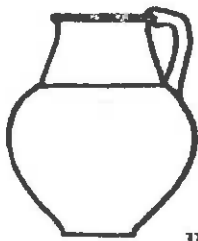

urceus

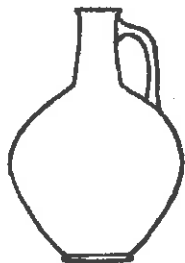
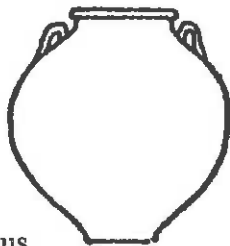

lagoena

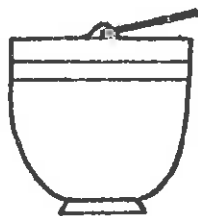

situla

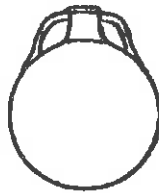

ampulla

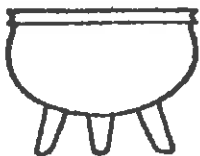

tripus

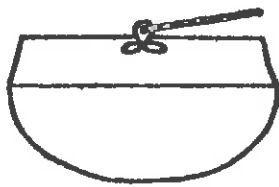

cortina



cupella, cupula



mortarium



caccabus



infundibulum



cribrum

**superficies** —ei, f.

est pars superior vel summa alicuius rei aut quidquid super faciem alicuius rei est vel fit vel exstat. a mathematicis superficies dicitur, quae extremitas a Cicerone, magnitudo longa et lata.

Macrobius, in somn. Scip. 2, 2, 4 ss:

„punctum corpus (est) individuum ... hoc protractum efficit lineam, ... hanc lineam si geminaveris, alterum mathematicum corpus efficies, quod duabus dimensionibus aestimatur, longo latoque, sed alto caret: et hoc est, quod apud illos superficies vocatur.“

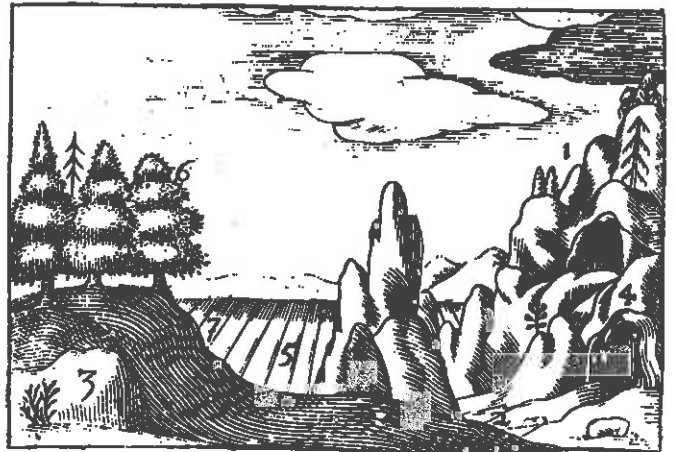

Comenius has partes superficii terrae distinguit: montes (1), valles (2), colles (3), speluncae (4), campi (5), silvae (6); quibus adiungi potest clivus (7).

**supplicatio** —onis, f.

- a) supplicatio est supplicandi actus, precatio in universum. (vide imaginem supplicis!)
- b) ponitur pro dei adoratione et gratiarum actione pro re aliqua, quae rei publicae prospere



supplex

evenit. apud Romanos supplicationes dicebantur, quando, re feliciter acta, ex senatus consulto *templa* aperiebantur divorumque simulacra in lectulis collocabantur sacra faciente pontifice et populo certatim ad pulvinaria conflente disique suis pro eorum in rem publicam meritis supplicante gratiasque agente. (*lectisternium*) Cicero, Prov. cons. 11, 27: „decem dierum supplicatio decreta Cn. Pompeio.“

### sutor –oris, m.

est is, qui calceos suat (suo, sui, suere), (*vestimenta*).

**proverbium:** „sutor, ne supra crepidam“, quo monemur, ne, quibus in rebus minus intellegimus, in his sententiam proferamus.

### sutrina –ae, f.

est officina sutoris.

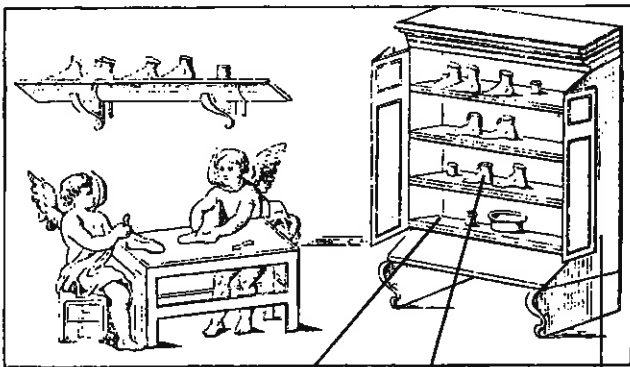

pluteus calceus, armarium  
crepida

in hac imagine Herculani depicta, videmus sutrinam; sutores sunt duo genii alati. in armario calcei (aut crepidae) impositi sunt pluteis. (*pluteus*)

### symbolum / symbolus

a) est *signum, nota*, indicium, ex quo quid cognosci potest.

b) est etiam anulus, quo utebantur Romani ad epistulas et vasa obsignanda et in pignus atque argumentum cuiuspiam rei promissae.

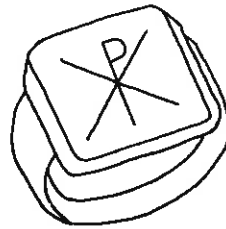

anulus symbolo  
instructus

c) est item *imago* ipsa anulo impressa.

Plautus, Pseudolus 55–58:

„ea causa miles hic reliquit symbolum, expressam in cera ex anulo suam imaginem, ut qui huc afferret eius similem symbolum cum eo simul me mitteret.“

d) apud ecclesiasticos scriptores symbolum est regula seu formula eorum, quae credenda sunt ex fide divina, qua fideles ab infidelibus discernuntur.

### systema mundi Ptolemaicum

in systemate mundano Ptolemaei terra medium locum mundi obtinet, circum eam feruntur planetae.

Cicero, de re publ. 6, 18:

„terra ... immobilis manens unā sede semper haeret, complexa medium mundi locum ...“

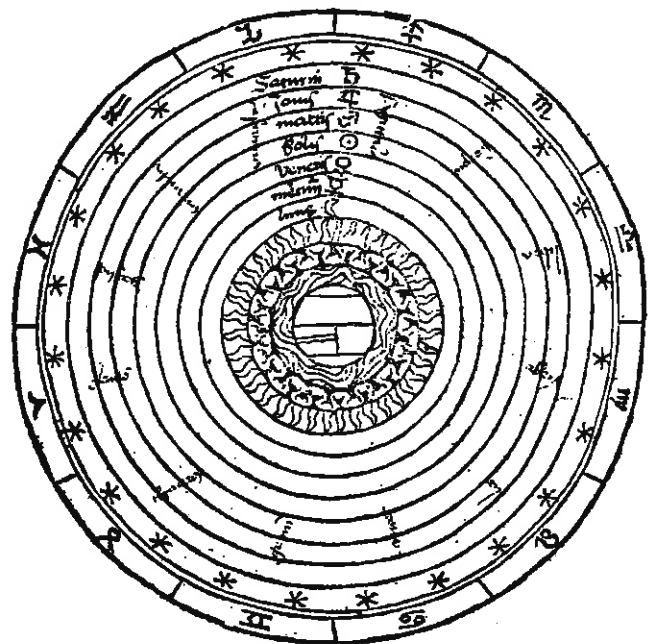

imago sumpta est e „Sphaera mundi“ Ioannis de Sacrobosco, Venetiis 1491

## taberna –ae, f.

a) taberna est aedificium utile ad habitandum, sed speciatim est *casa* humilis et pauper.

Horatius, *carm.* 1, 4, 13/14:

„pallida mors aequo pulsat pede pauperum tabernas

regumque turres ...“

b) latiore sensu dicitur de loco, ubi merces vèneunt et ubi *artifices* artem suam profitentur, e. g. taberna libraria, taberna sutrina, taberna vinaria.



## tabernaculum –i, n.

tabernaculum est subitarium tectum, frondibus aut stragulis opertum, adversus solis et aeris iniurias: qualia sunt, quae in castris excitantur et modo huc modo illuc transferuntur.

\*\*in ecclesia catholica, tabernaculum est pars altaris, ubi *calices* et ostensoria conduntur.

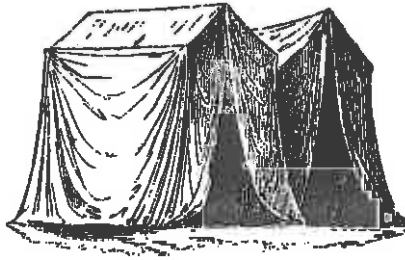

## tabula –ae, f.

tabula geographica antiquis temporibus itinera maritima aut terrestria eorumque longitudines indicabat, ut Tabula Peutingeriana hic infra.

Conradus Peutingerius (1465–1547) Augustae Vindelicorum (hodie Augsburg) vixit primusque antiquitates Romanas et Graecas collegit.

pars Tabulae Peutingerianae, quae Romam portumque (*portus*) Ostiensem cum Pharo (*pharus*) continet.

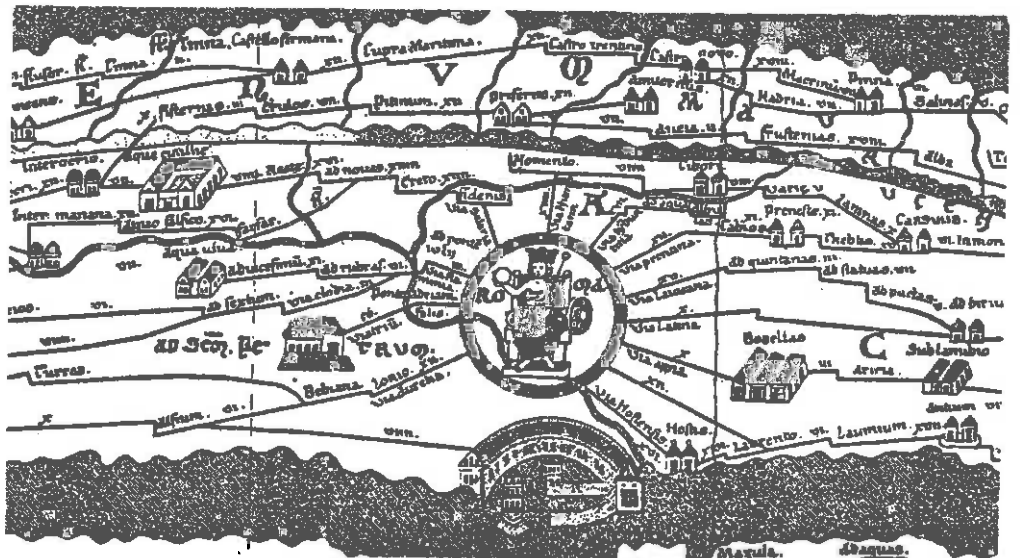

## taeda –ae, f.

a) taeda est genus arboris picem ferentis, ut pinus, picea.

Plinius, *H. N.* 16, 52:

„pix liquida in Europa e taedā coquitur navalibus muniendis multosque ad alios usus.“

b) taeda est assula taedae facile ardentis.

Valerius Flaccus, 2, 235:

„inicere taedas ad fastigia tectorum.“  
synonymum: *fax*.

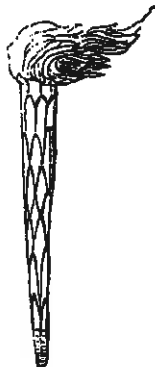

## talaria –ium, n. pl.

adi. talaris, –e, ad talum pertinens.

a) talaria sunt partes pedum circa talos (*talus*).

b) talaria sunt calceamenta alata, qualia Mercurio tribuuntur.

Vergilius, *Aen.* 4, 239ss: (Mercurius)

„... pedibus talaria nectit, aurea, quae sublimem alis sive aequora supra seu terram ... portant ...“

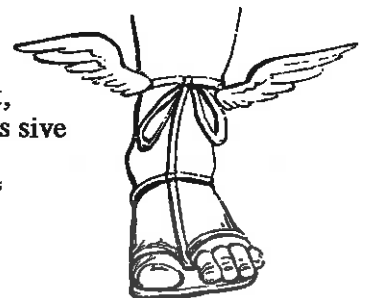

## talio –onis, f.

est aequalis retributio, par vindicta, ita ut aliquis talē quid patiatur, quale fecit. exempli gratia: si quis alteri oculum eruit, ipsi quoque oculus eruatur; hoc autem est: ius (aut legem) talionis adhibere.

## talpa –ae, f.

est animal muri simile, nigri coloris et ex vulgi opinione captum oculis, quod arva et hortos (*hortus*) suffodit.

Cicero, Acad. II, 81:

„quid? talpam num desiderare lumen putas?“

Plinius, H. N. 8, 104:

„Varro auctor est, a cuniculis suffossum in Hispania oppidum, a talpis in Thessalia.“

## talus –i, m.

a) talus est in homine os in extrema tibia supra calcem. (*calco*)

b) a similitudine est os quasi cubicae figurae in articulo pedis multorum animalium.

his talis antiqui in ludis utebantur, sed homines ditiores, spretis ossibus, talos ex ebore, crystallo aliave nobiliore et pretiosiore materia factos adhibebant. (*astragalus*)

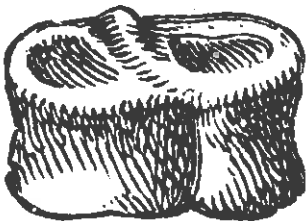

talus vel astragalus



talorum ludus

## tector –ris, m.

est opifex qui parietes (*paries*) vel gypso vel arenā, pavimenta (*pavimentum*) autem vel marmore vel opere testaceo induit. (*tectorium*)

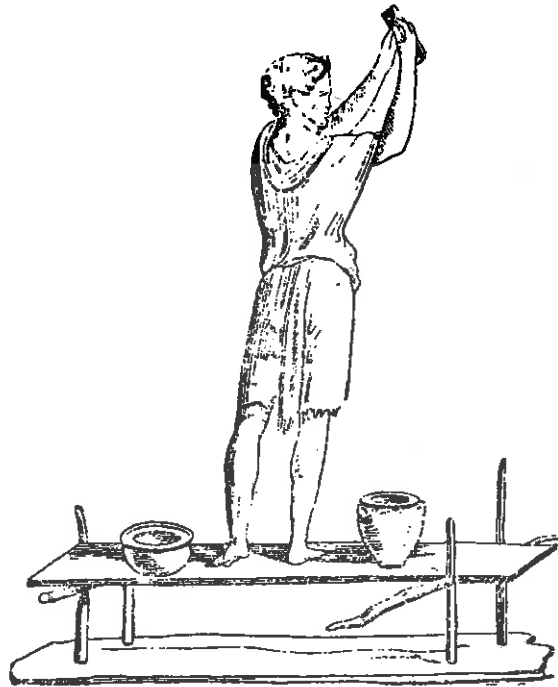

## tectorium –i, n.

est quicquid parieti (*paries*) exstructo vel pavimento (*pavimentum*) inducitur; hinc multiplex est genus tectorii: opus albarium, opus arenatum, opus marmoratum, opus testaceum.

Varro, r. r. 3, 8, 1:

parietes ac *camarae* munitae tectorio.

## tegula –ae, f.

est testae (*testa*) aliusve materiae genus, quo domūs teguntur.

Plautus, Mil. glor. 504:

„quod meas confregisti imbrices et tegulas.“  
imbrices rimas tegularum operiunt impediuntque, ne imber penetret inter tegulas.

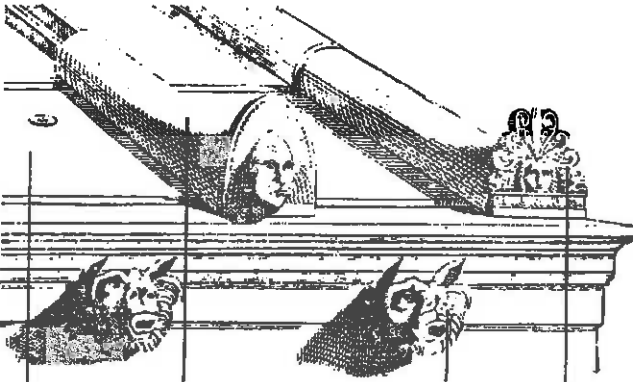

tegula imbrex stillicidium antefixum

## Tellus –uris, f.

est mater terra. de qua Varro primo libro, capite primo Rerum Rusticarum haec:

„primum invocabo qui omnes fructus agriculturae caelo et terra continent, Iovem et Tellurem; itaque quod ii parentes magni dicuntur, Iuppiter pater appellatur, Tellus terra mater.“

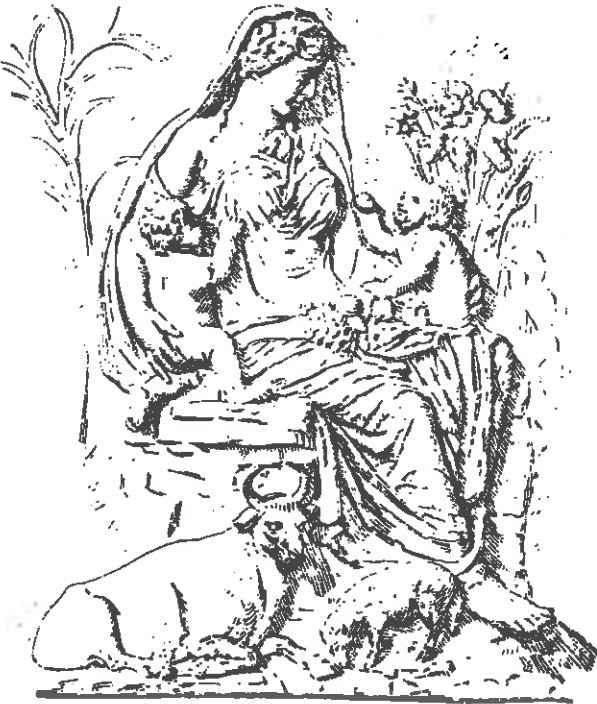

Tellus = mater terra, opus caelatum in Ara Pacis Augusti.

## temo –onis, m.

temo est lignum longum et extentum in curru vel aratro (*aratrum*), cui iugum in anteriore parte adnectitur.

Ovidius, Met. 2, 107s.:

„aureus axis erat, temo aureus, aurea summae curvatura rotae ...“

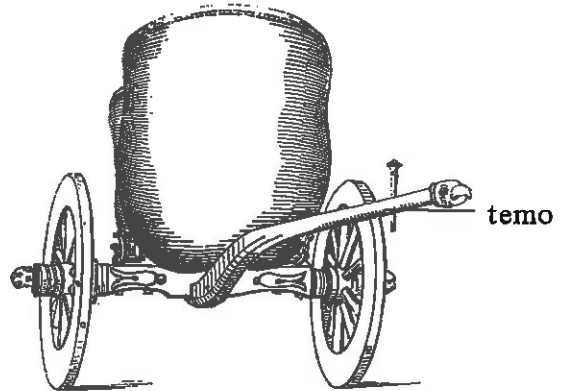

## tempestas –atis, f.

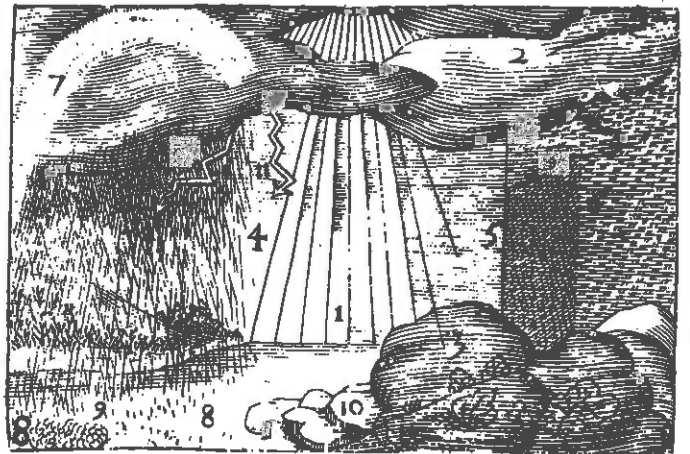

hac imagine Amos Comenius (1592–1670) in *Orbe Sensualium Picto* tempestates describit:

„ex aqua ascendit vapor (1), inde fit nubes (2) et prope terram nebula (3). e nube guttatim stillat pluvia et imber (4). pluvia gelata grando (5), semigelata nix (6) est. in nube pluviosa, soli opposita, apparet Iris (7).

gutta incidens in aquam, facit bullam (8), multae bullae faciunt spumam (9).

aqua congelata glacies (10), ros congelatus pruina dicitur. ex vapore sulphureo fit tonitru, quod, erumpens e nube cum fulgure (11) tonat et fulgurat.“

vapor, –oris, m.; nubes, –is, f.; imber, –bris, m.; grando, –inis, f.; nix, nivis, f.; iris, –idis, f.; glacies, –ei, f.; tonitru, –truis, n.; fulgur, –uris, n.

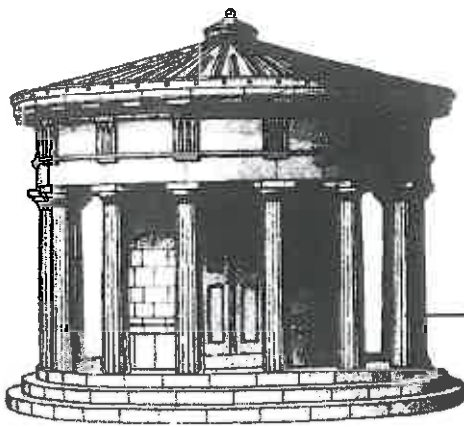

columna

aedis rotunda (tholus) prope Delphos

a) templum est sectio, segmentum alicuius rei, vel circuitus rei a toto resectus ac definitus, vel spatium aliquod certum, praecipue auguris designatum et sacrum (*augurium*).

Isidorus, orig. 15, 4, 7:

„(templi) partes quattuor erant, antica ad ortum, postica ad occasum, sinistra ad septentrionem, dextra ad meridiem spectans; unde et quando templum construebant, orientem spectabant aequinoctialem (aequinoctium), ita ut lineae ab ortu ad occidentem missae, fierent partes caeli dextra atque sinistra aequales, ut qui consuleret ac deprecaretur, rectum aspiceret orientem.“ (*regiones caeli*)

formae templorum:

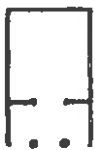

templum in antis



prostylos

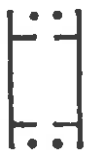

templum in antis duplex



amphiprostylos

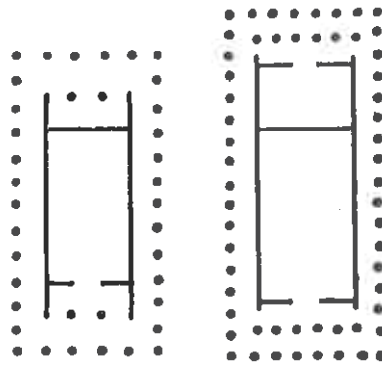

peripteros

ita templum est spatium, quod certo carmine ab augure (*augur*) lituo (*lituus*) finitum et notatum consecratumque esset, unde in omnes caeli partes liber erat aspectus.

b) „templum“ saepe etiam dicitur de aedibus, quae deis consecratae erant.

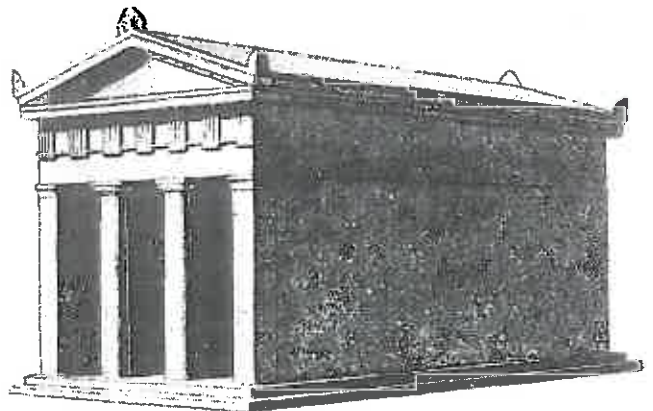

templum in antis, thesaurus Megarensium, Olympiae

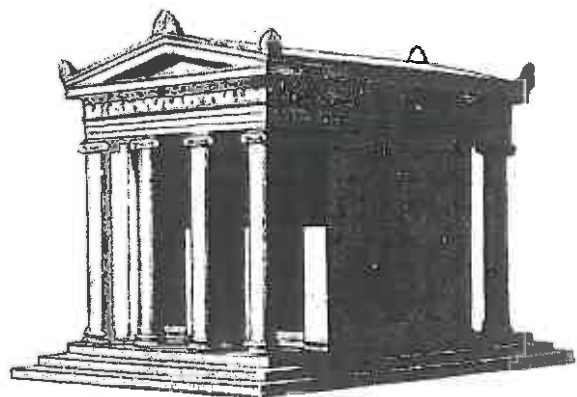

amphiprostylos, templum Victoriae (= Nices) Athenis

tensa -ae, f.

est vehiculum, quo exuviae deorum ludicris circensibus in circum (*circus*) ad *pulvinar* vehuntur.

tensa est vehiculum, quo deorum *signa* atque exuviae in pompa transferuntur.

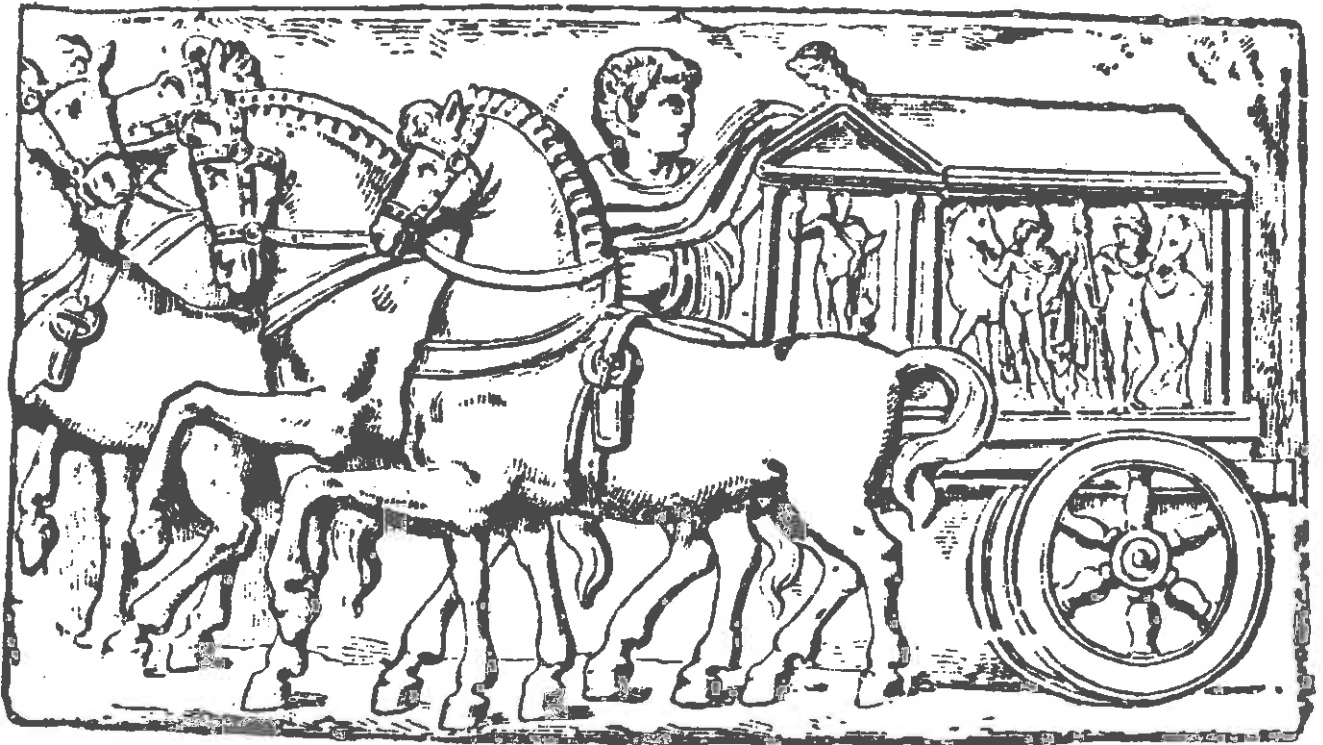

tentorium -i, n.

est *velum* funibus (*funis*) tensum, *papilio* extensis velis contra solem caelique iniurias excitatus; quo milites praecipue in expeditionibus uti solent. (cui opponitur *tabernaculum*, quod ligneum erat.)

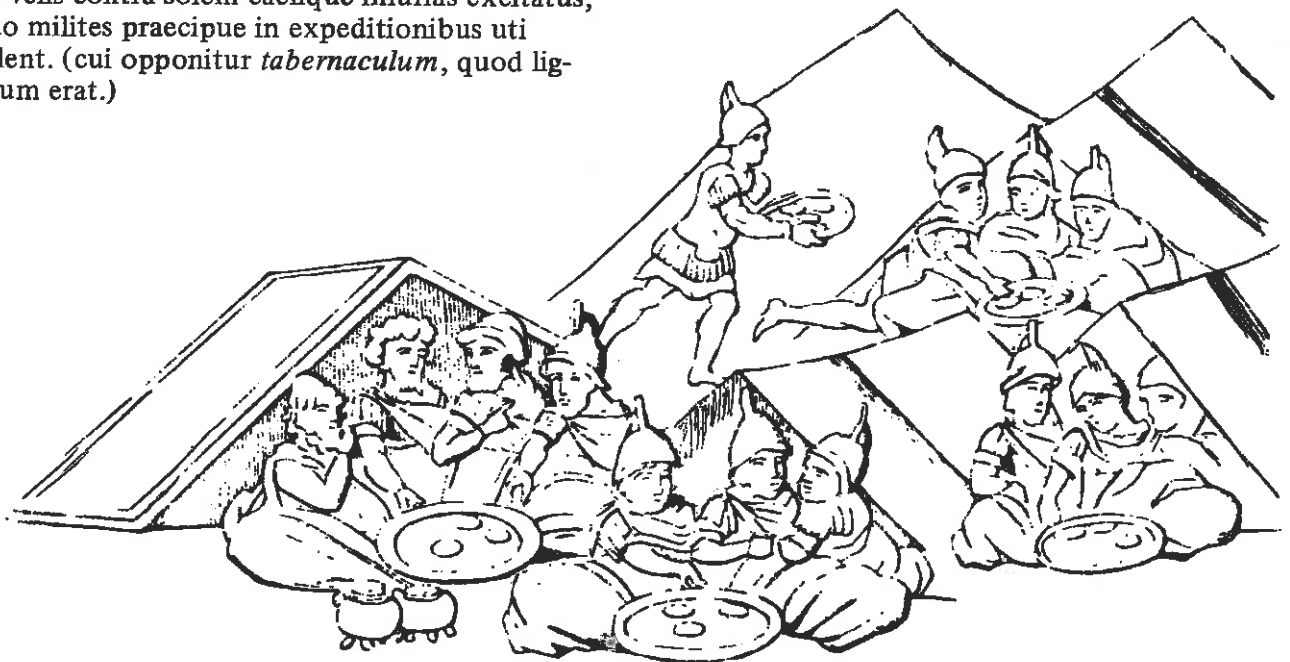

in nostra imagine e manuscripto Iliadis sumptā milites ante tentoria cubant cibumque sumunt

## terebra —ae, f.

est instrumentum, quo quid, praesertim lignum, perforatur.

verbum: terebro, —are.

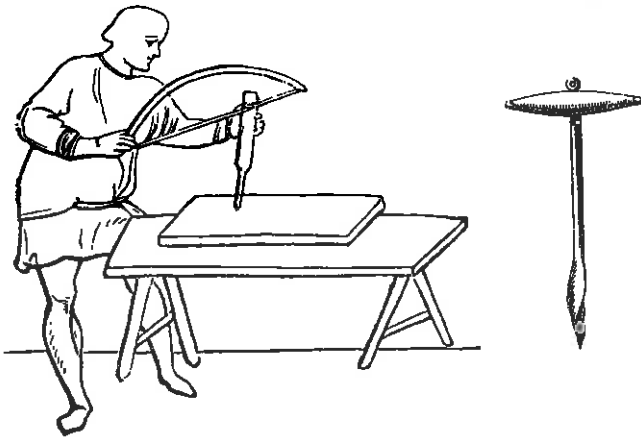

## \*\*\*terra sigillata —ae, f.

sigillo 1. est signo instruere, munire. sigillatus, —a, —um, est sigillis seu imaginibus ornatus. (*signum*)

Cicero, Verr. 4, 14, 32:

„iubet me scyphos sigillatos ad praetorem statim afferre.“

saepe putealia (*puteal*) etiam sigillata sunt. multa vasa e terra sigillata facta sunt, ex gratia *lucernae*, ut figura demonstrat.

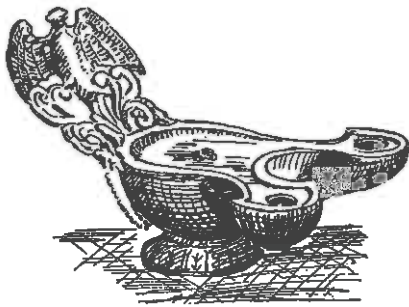

## tessera —ae, f.

est id, quod figurā quadratum est, sive naturā ita factum, sive ut plurimum, arte, constans sex lateribus.

tribus dimensionibus impletis fit corpus solidum, qualis est tessera, quae *cubus* vocatur.

a) tesserae, dem. tesserae, vel tessellae, e quibus *opus tessellatum* perficitur in pavimentis (*pavimentum*) aedificiorum.

b) *tesserae lusoriae* sunt cubi ossei vel lignei punctis distincti, quibus in alveolum iactis luditur.

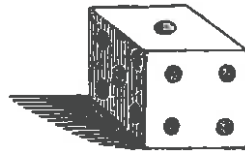

tessera lusoria (*cubus*)

c) *tessera hospitalis* est *symbolum* amicitiae vel coniunctionis.



d) *tessera frumentaria* indicat numerum congiorum (*congius*), quem quisque in congiario (*congiarium*) recipit.

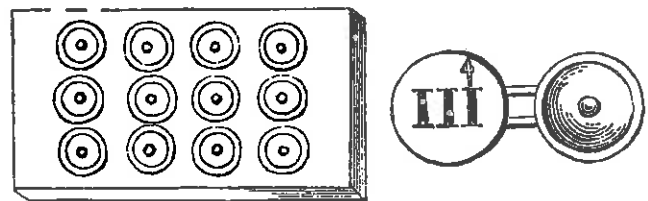

e) \*\*\*hodie tesserae tramitis, theatri, vestiarii aliarumque rerum in usu sunt.

## testa —ae, f.

est *terra* vel *argilla cocta* vel aliquid ex terra cocta in formam aliquam compositum: hinc est nomen generale cuiuscumque vasis fictilis cocti, ut vasa escaria et vinaria, *lucernae*, urceoli, calices (*calix*), etc.

proverbium apud *Horatium*, ep. 1, 2, 69/70:

„quo semel est imbuta recens, servabit odorem testa diu ...“

translate etiam dicebatur de *cranio*, hinc „testa“ Italicorum, „tête“ Francogallicorum.



testa



**testudo** –inis, f.

a) testudo est animal ex genere amphibiorum, testā coniectum, quadrupes, tardigradum, capite brevi, cervice anguinā.

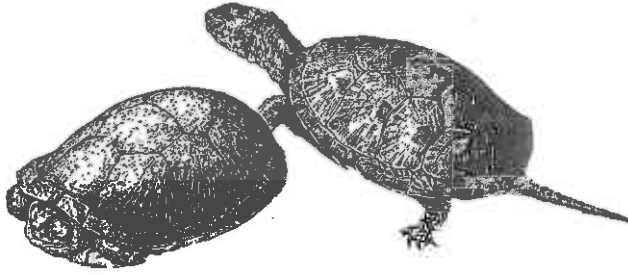

b) testudo dicitur etiam de instrumento musico, in quo fides extenduntur, cithara, barbiton et alia. (*instrumenta musica*)  
c) in re militari testudo est, cum conglobati milites et scuta scutis arcte iungentes, invicem se protegunt et ingruentia tela defendunt.

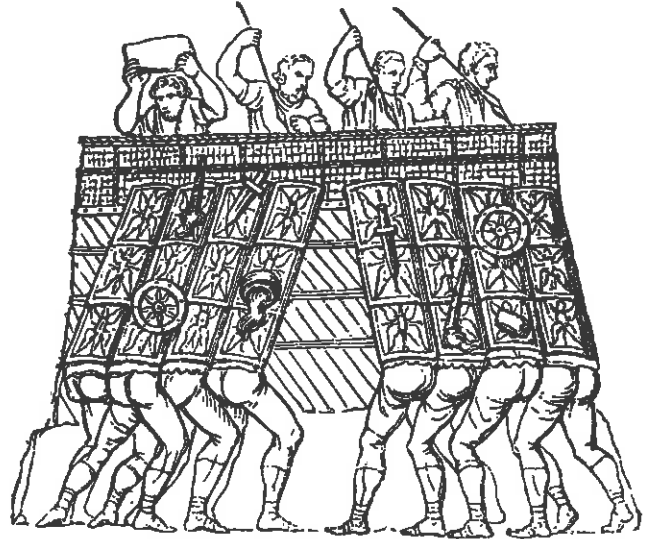

testudo militaris

**textor** –oris, m. / **texrix**, –icis, f.

textor est is, qui pannos texit. texere est filum filo conserendo telam conficere.

textum, –i, n. est vestis texta, pannus et quodcumque opus textum.

tela est quidquid ex lana, lino sericove texendo conficitur.

textus, –ūs, m. est ratio texendi, textura. translate refertur ad contextum orationis.

Ammianus, 15, 7, 6:

„(rem) brevi textu percurram.“

initium facere legendi vel narrandi = (ex)ordiri:

Vergilius, Aen. 2, 1 et 2:

„conticuere omnes ...

inde toro pater Aeneas sic orsus ab alto ...“



**theatrum** —i, n.

est aedificium semicirculi specie ad spectandos ludos scaenicos factum. primo stantes aderant spectaculis, crescente luxu theatra facta sunt, ut a sedentibus spectaretur. primo lignea fuerunt et temporaria, quae peractis ludis solverentur;

postea ex lapide structo et mansura. in his erant scaena, ubi actores agebant; orchestra, ubi edebantur saltationes, gradūs (cuneatim divisi) in cavea, ubi sedebant spectatores.  
(*cuneus, amphitheatrum*)

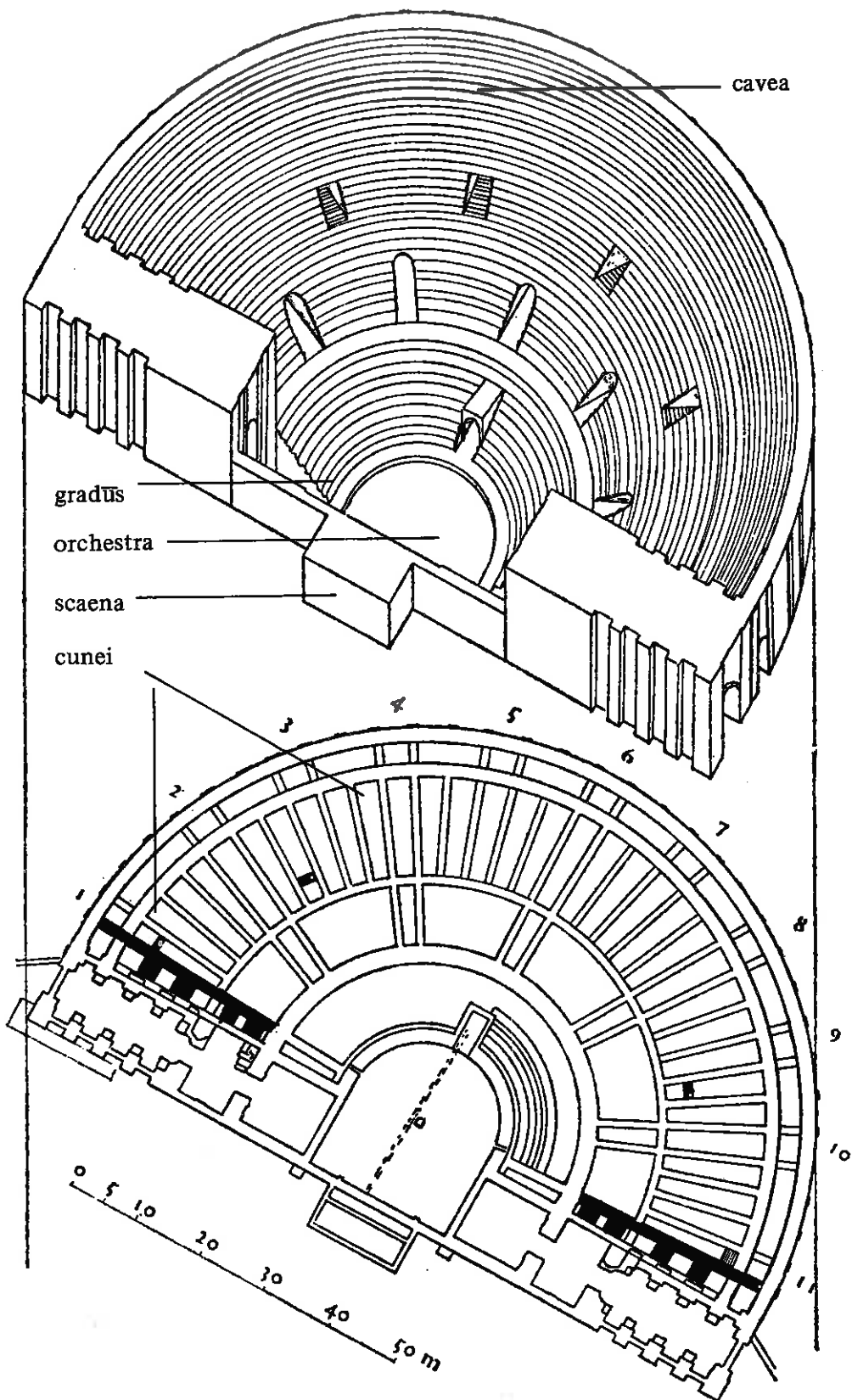

imago theatrum Aventici inventum monstrat

## thermopolium –i, n.

est *caupona*, ubi calida venduntur.

Plautus, Trinummus, 1013/14:

„satin in thermopolio  
condalium es oblitus, postquam  
thermopotasti gutturem?“

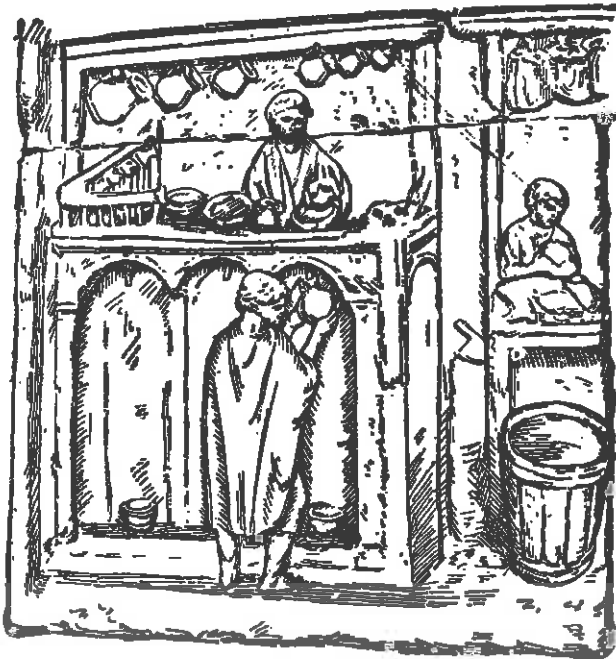

## thesaurus –i, m.

(e Graeco *thēsaurós*)

a) est collectio rerum pretiosarum, quae in futuros usus reconduntur.

Plautus, Trin. 1100s:

„thesaurum effodiebam intus, dotem filiae tuae quae daretur.“

b) est locus, ubi res pretiosae reconduntur, apotheca.

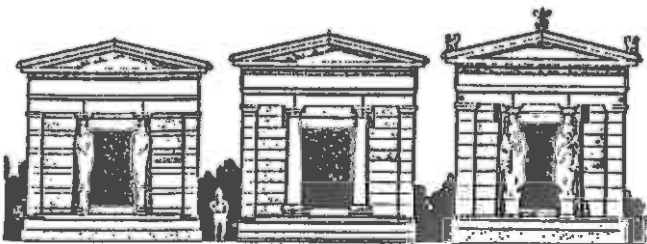

thesauri Cnidiorum, Massiliensium et Siphniorum Delphis erecti

## thyrsus –i, m.

est hasta aculeata, hederis et pampinis oblecta, quam Bacchus gestare solitus fuit et Bacchae in orgiis quatiebant.



## tiara –ae, f. (vel tiaras, –ae, f.)

tiara est ornamentum capitis. erat in usu apud Persas, quorum reges soli recta tiara et cum apice utebantur. etiam apud Phrygas fuit eius usus, sed sacerdotibus praecipue et regibus.



tiara recta



## tibicen –inis, m. (tibicina, –ae, f.)

tibicen est is, qui tibiā canit.

Cicero, de orat. 2, 83, 338:

„tibicen sine tibiis canere (non potest).“

tibia, –ae, f.

a) tibia est *os* cruris exterius.

b) tibia dicitur instrumentum musicum, teres et foraminosum, ex arundine aut buxo aliove ligno, vel ex cruribus gruum, cervorum aut

asinorum, interdum ex ebore, aere aliave materia ductili. (*instrumenta musica*)



tubicen



tubicina

### tignarius —i. m.

faber tignarius tigna dolat, in asses et tabulas secat et domorum tecta et contignationes facit. (*contignatio*)

serra                      scalprum              runcina



ascia

officina tignarii

discus vitreus ornamentis inauratis praeditus

### tinctor —oris, m.

nomen actoris, derivatum a verbo tingere (tinxi, tinctum).  
tinctorium dicitur de loco, ubi vestes tinguntur.  
actio tinctoris est tinctura, i. e. infectio, inductio coloris.



imago repraesentat *titulum* sepulcralem cuiusdam tinctoris, varia utensilia ostendentem, ut spatham (1), ampullas colorum (2), libram (3), lanæ glomera (4)

### tintinnabulum —i, n.

est instrumentum e metallo (ex aere, stanno, argento aut plumbo) factum, quod percussum tinnitum edit.

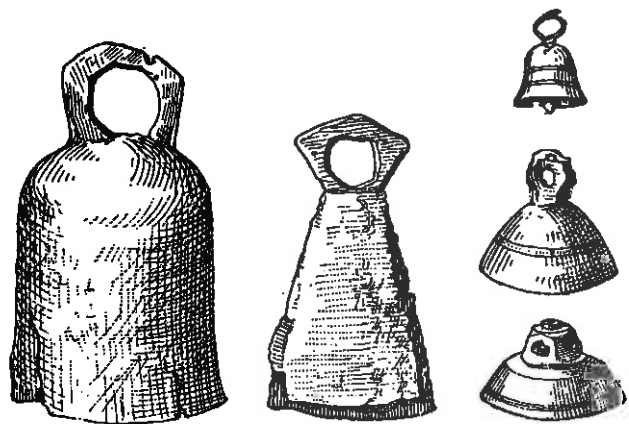

## titulus —i, m.

est inscriptio, nota, index, elogium, quo res dignoscitur, et quid valeat, contineat, cuius sit, cur facta sit, monstratur, ut titulus sepulcri, aedium, libri, statuae, picturae et huiusmodi; exempli gratia titulus, qui in ecclesiā Wettingen, prope Aquas, parieti (*paries*) infixus est:  
DEAE ISIDI TEMPLUM A SOLO  
L. ANNUSIUS MAGIANUS  
DE SUO POSUIT VIK (anis) AQUENSIB (us)  
AD CUIUS TEMPLI ORNAMENTA  
ALPINIA ALPINULA CONIUNX  
ET PEREGRINA FIL (ia) (denarios) C DEDE-  
RUNT L (ocus) D (atus) D (ecreto)  
VICANORUM.

## tolleno —onis, m.

tolleno est genus machinae, quā extolluntur pondera (*pondus*), eiusque usus erat etiam in re militari. trabi (trabes) in terram defixae superne imponitur et deligatur altera transversa, quae nunc sustollitur, nunc deorsum agitur.

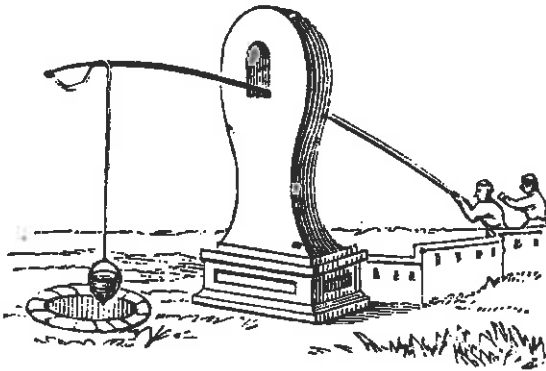

tolleno in pictura Pompeiana illustratus

## tonsor —oris, m.

tonsor capillos alicuius forfice (*forfex*) tondet et barbam novacula radit. eius taberna est tonstrina. servi iuvenes capillis longis intonsis dignoscebantur; capillati nominabantur. liberis capilli tonsi erant.

Martialis, 7, 61, 1ss:

de vico tabernis obstructo

„abstulerat totam temerarius institor urbem“  
postea vero, Germanico iubente, calles viae  
amplae factae sunt:

„nulla catenatis pila est praecincta lagonis,

nec praetor medio cogitur ire luto,  
stringitur in densā nec caeca novacula turbā.“  
caeca vel obtusa novacula stringitur vel acuitur  
cote. (*cos*)

forfex

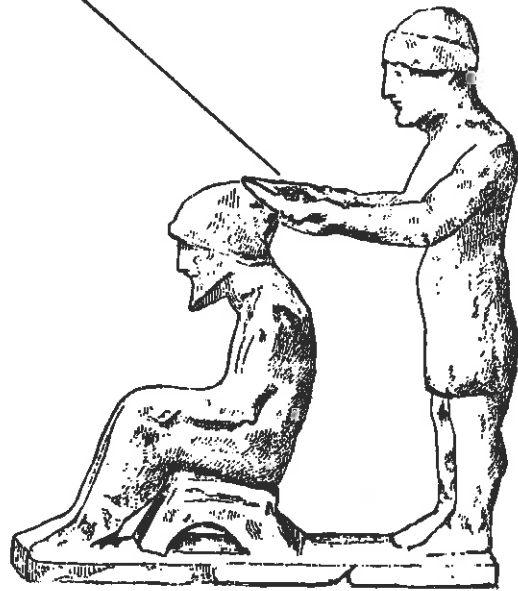

tonsor in tonstrinā

## toral —is, n.

toral est stragulum, quod circa torum (*torus*) apponitur ornatūs gratiā.

Horatius, ep. 1, 5, 22s:

„... ne turpe toral, ne sordida mappa  
corruget nares ...“

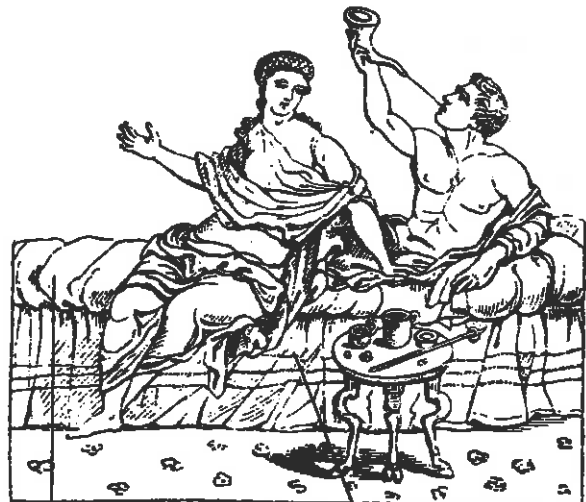

torus

toral

## torculum —i, n.

vel torcular, —aris, n.

est locus, ubi prelum est et prelum ipsum.

(*pressorium*)

vinea, —ae, f. est locus, vitibus consitus vel multitudo vitium simul consitarum = vinetum.

interdum vinea dicitur pro una vite,

Phaedrus, 4, 3:

„vulpes alta in vinea

uvam appetebat summis saliens viribus.“

uva est fructus vitis.

Varro, r. r. 1, 54, 1:

„in vinetis uva cum erit matura, vindemiam ita fieri oportet, ut videas, a quo genere uvarum... incipias legere.“

Tibullus, 2, 1, 45:

„aurea tunc pressos pedibus dedit uva liquores.“  
vinitor uvas legit in torculoque premit.

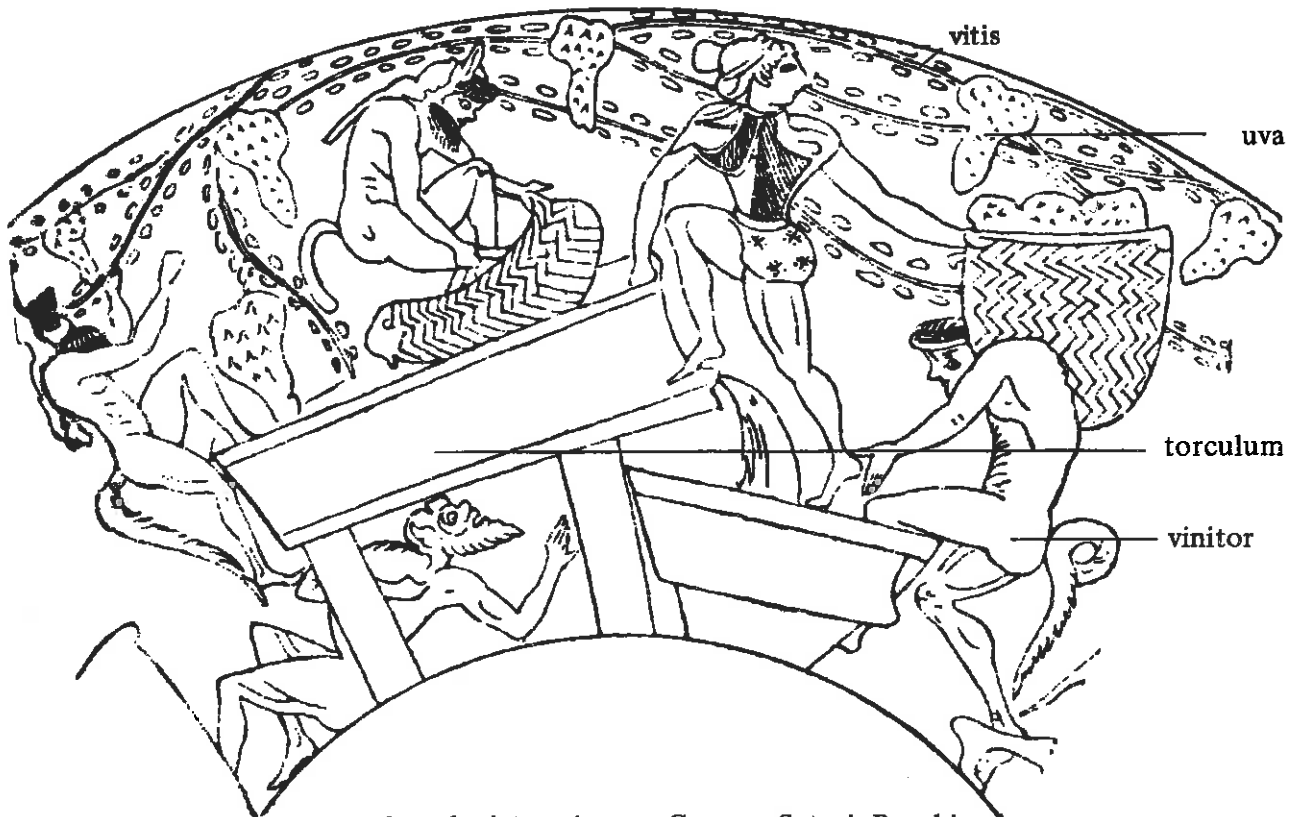

torculum depictum in vase Graeco: Satyri, Bacchi servitores, uvas pedibus in torculo premunt.

## torques —is, m.

torques est circulus aureus vel argenteus, aliquando gemmis ornatus, qui ex pluribus filis in se re-tortis in collo et ante pectus pro ornamento gestatur.

Isidorus, orig. 19, 31, 11:

„torques ... et bullae (*bullae*) a viris geruntur, a feminis monilia (*monile*) et catellae.“



451

## torus —i, m.

a) torus est funiculus tortus, qui duplicatus aut triplicatus funem facit.

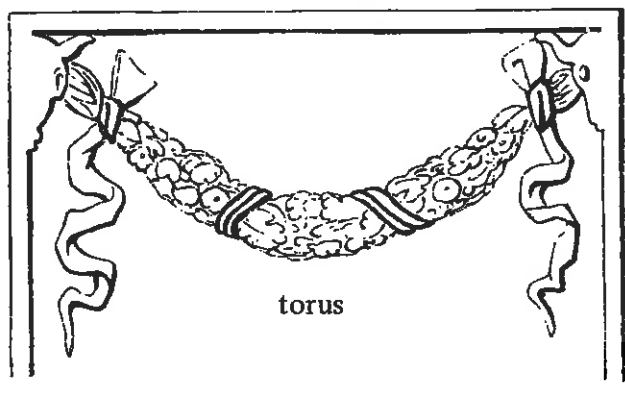

torus

452

b) in architectura, torus est membrum turgens, rotundum et oblongum instar funis.

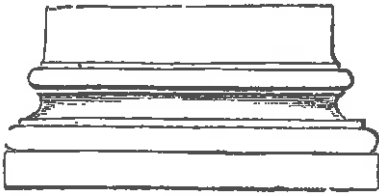

tori in basi columnae

c) item dicitur de venis tumentibus.

d) translate torus est culcita, quae lecto (*lectus*) imponitur sive discubitorio sive funebri sive cenatorio, sic dicta a rotunditate pulvinorum, quibus discumbentes incumbebant.

Vergilius, Aen. 2, 2:

„inde toro pater Aeneas sic orsus ab alto.“

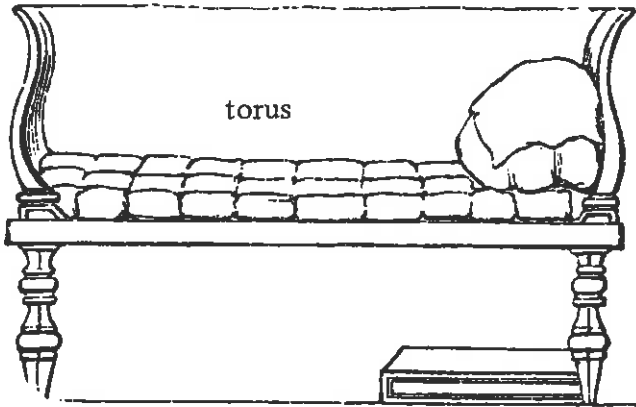

### traha —ae, f. vel trahea, —ae, f.

traha est genus vehiculi sine rotis (*rota*), quo rustici utebantur et quo per nivem vehuntur. etiam est machina, qua *navis* e mari in siccum trahitur.

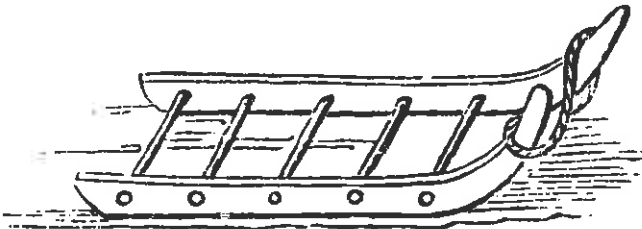

### transenna —ae, f.

transenna significat opus cancellatum seu reticulatum.

a) est *rete* ex funiculis cancellatis factum ad struendas avibus insidias.

b) etiam *crates* seu cancelli ferrei vel lignei vel viminei, qui fenestris aut etiam mercibus oppositi visui pervii sunt.

formula dicendi: „per transennam aspicere aliquid“ = non propius neque singillatim, sed procul, obiter et summatim inspicere.

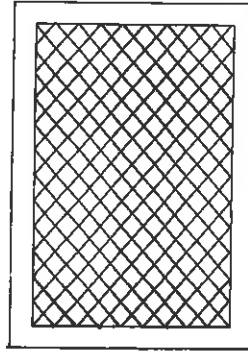

### tribulum —i, n.

tribulum est rusticum instrumentum, quo frumenta in *areā* teruntur. Id fit e tabulā longā lapideis aut ferro asperatā, quae trahitur iumentis iunctis, ut discutiat e *spicā* grana.

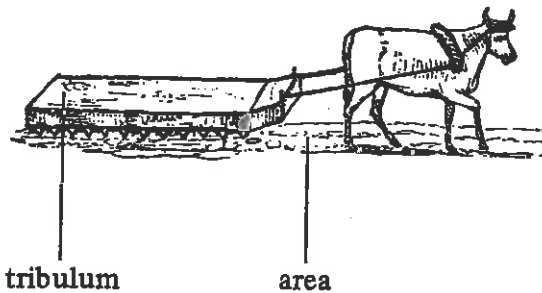

## triclinium -i, n.

tres lecti (*lectus*) tricliniaries modo soleae (*solea*) ferreae circum mensam positi, in quibus novem convivales accumbebant. sinistro cubito nixi dextra manu cibos sumebant de mensa. (*corpus humanum, domus Romana*)



## tridens -entis, m.

est instrumentum tribus dentibus vel cuspidibus munitum (est „*tricuspis*“, „*trifidus*“). dicitur etiam de ferro piscatorio, hastae praefixo, quo maiores pisces transfiguntur (= *fuscina*). *tridens symbolum*, attributum est dei Neptuni. *tridens* fuit telum gladiatoris *retiarii*.



## \*\*triforium -i, n.

adi. triforis, h. e. tres fores ostentans. triforium est *porticus*, quae totum aedis sacrae aedificium ambit, eo fine ducta, ut transitum praebet locum circumire vel lustrare volentibus, in ipso aedis muro, supra inferiorum columnarum (*columna*) et arcuum (*arcus*) ordinem.

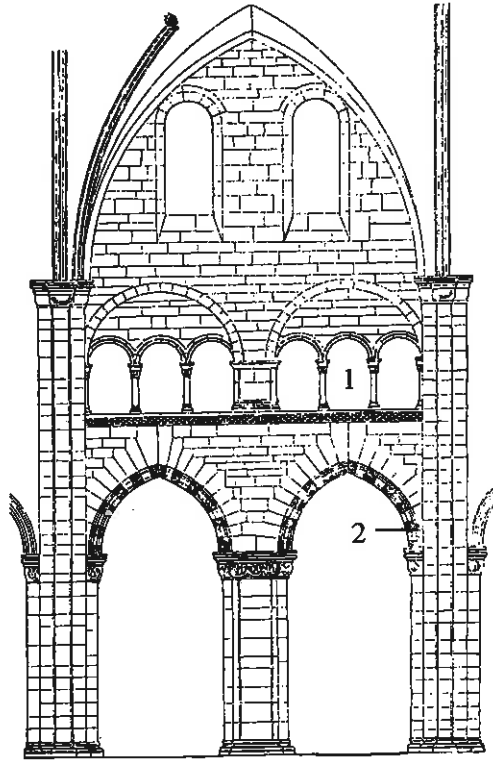

1 triforium in interiore ecclesia cathedrali Basiliensi  
2 ordo inferiorum arcuum

## Triptolemus -i, m.

Atheniensis, filius *Celei*, regis Eleusinis. is primus in Graecia *agriculturae* rationem creditur invenisse. de eo haec fabulantur: cum eius pater *Cerem*, filiam quaerentem, liberalissime hospitio suscepisset, illa pro remuneratione ostendit ei omne genus *agriculturae*, filium etiam eius *Triptolemem* recens natum, per noctem igne fovit, divino lacte nutrit et eum alatis serpentibus superpositum, per totum orbem misit ad usum frumentorum hominibus indicandum.



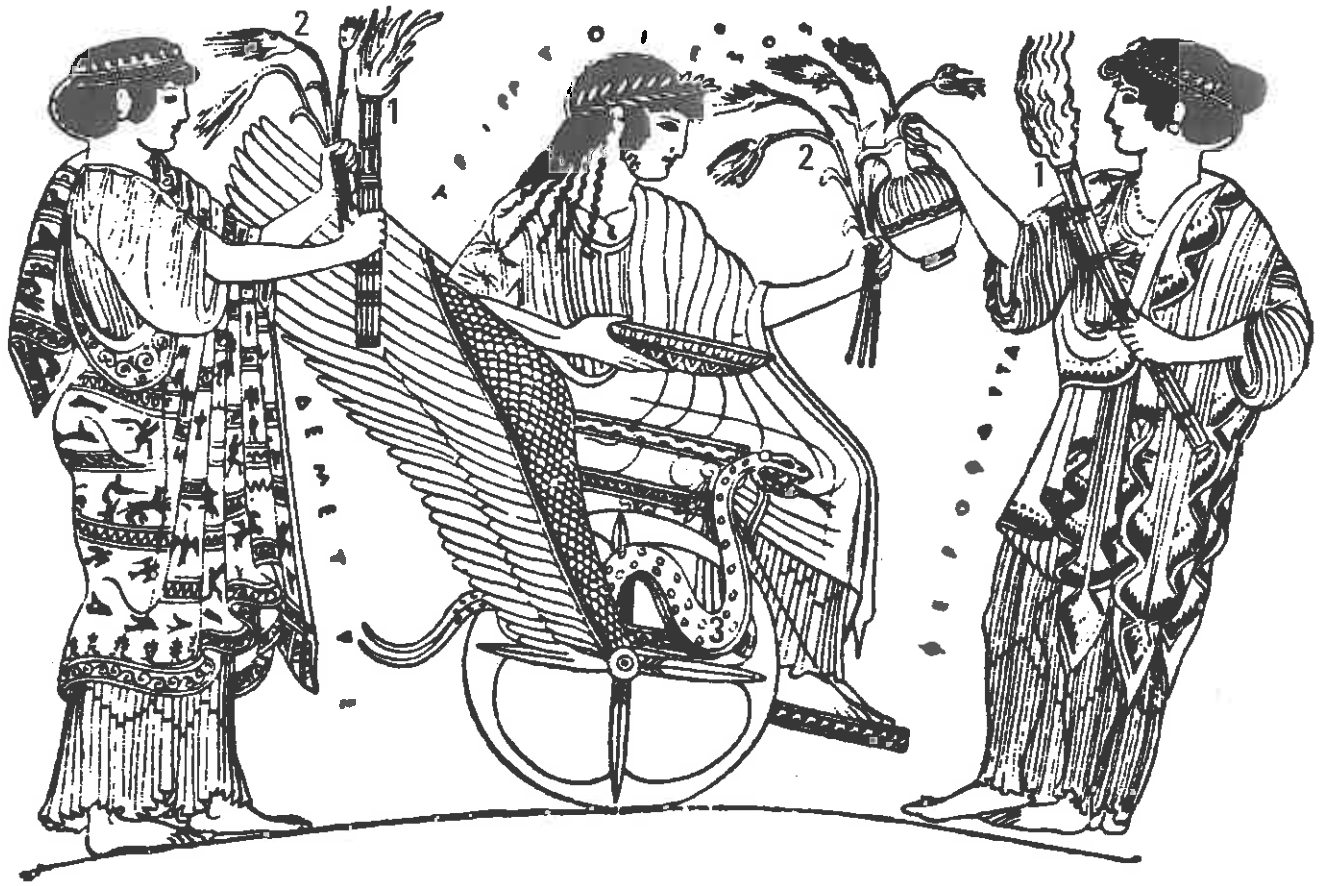

in imagine sinistrā est Ceres, dextrā Proserpina. ambae deae facem (1) mysteriorum tenent, Ceres Triptolemusque manipulum (2) spicarum portant. (*fax, manipulus, spica*) (3) serpens alatus.

**tripus —odis, m.**

tripus est, qui tres pedes habet vel fulcra, quibus sustinetur, ut vas, sella et huiusmodi. (*cortina*)

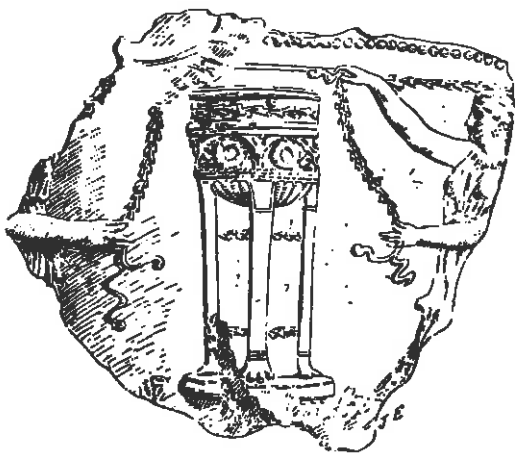

Pythia in tripode sedens, de qua Lucretius 1, 739: „Pythia quae tripode a Phoebi lauroque profatur.“



## Triton –onis, m.

Triton est semideus marinus, filius Neptuni et Salaciae nymphae marinae, quem poetae fingunt Neptuni tubicinem esse eiusque tubam (tuba) etiam latissime longissimeque sonantem. Triton hominis atque piscis formam habet volatque supra mare curru equis caeruleis recto; saepe etiam sub forma centauri natantis apparet. conchā marinā canere solet. in dorso

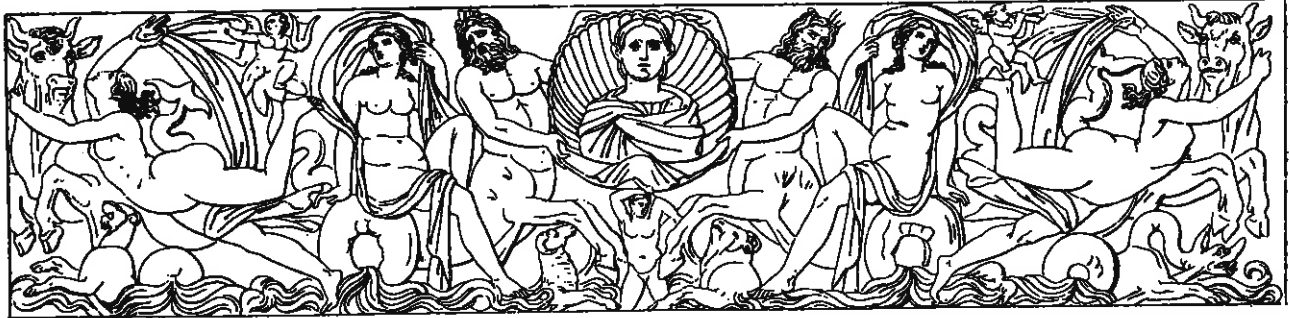

Tritones Nereidesque

## triumphus –i, m.

triumphus est genus honoris qui haberi solitus est iis, qui imperium a populo acceptum summā cum virtute ac felicitate administrassent, nimirum ut domum redeuntes magnā cum celebritate et pompā in Urbem ingrederentur, ubi saltationes, cantica aliaque laetitiae signa edebantur, hinc et pro victoriā accipitur. imperator auratis quadrigis, laureā coronatus, dextrā lauri ramos tenens, os minio illitus, bullā ornatus, vestibus triumphalibus indutus, i. e. tunicā palmatā et togā pictā, vehitur. legati et tribuni militum in equis et pedibus exercitus omnis victor laureatus cum cantu et clamore imperatoris currum comitantur.



vestis triumphalis

## trivium –i, n.

trivium est locus in quem tres viae<sup>1</sup> conveniunt, ut bivium, in quem duae, quadrivium in quem quattuor. (compitum) trivium et quadrivia erant rusticorum sacris attributa, nam ibi oves caedebant et sarta appendebant. \*\*trivium nominantur tres primae artes artium liberalium, nempe grammatica, rhetorica, dialectica. (artes liberales).

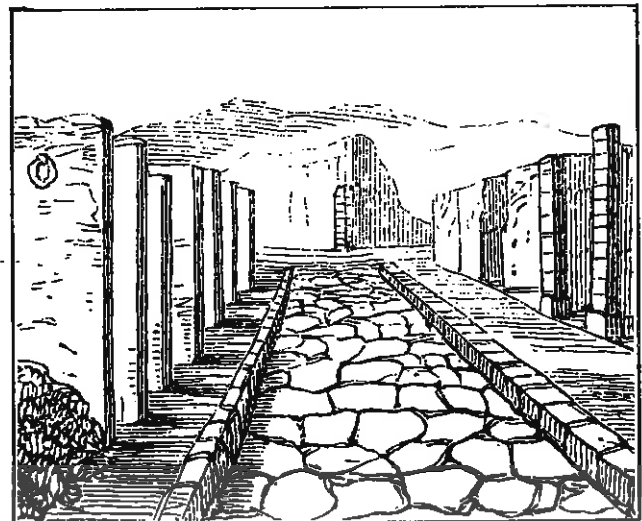

## trochus —i, m.

est circulus seu *rota* ferrea, quae ludi causā a pueris ferreo manubrio, quod *clavis* dicebatur, impulsā mittebatur. habebat saepe circum infixos parvos anulos, qui dum iaceretur, tinnitum et sonum reddebant. trochus differt a turbine, quia *turbo* erat ligneus, sed non circularis, at in modum *metae* factus.

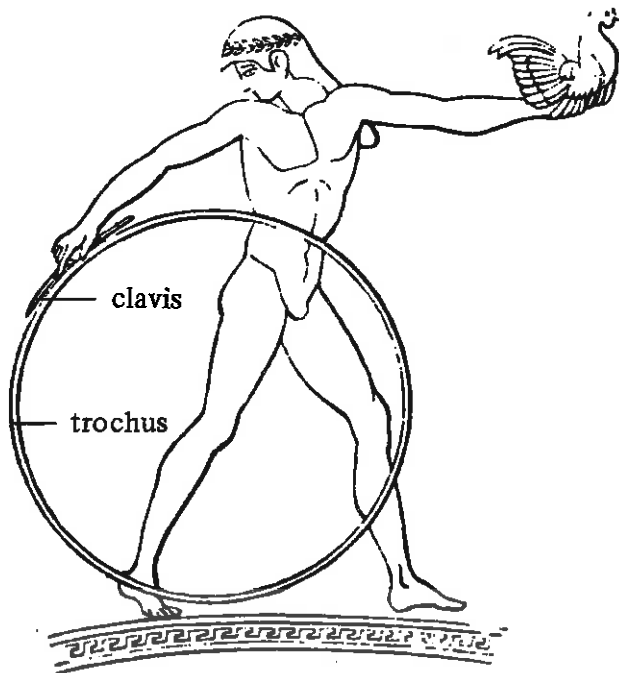

Ganymedes trochum clave impellens

## troia vel trua

vel *Troianus ludus*, erat equestris ludus puerorum apud Romanos, qui cursu labyrinthico constabat. ludus Troianus a *Vergilio* in *Aeneide* 5, 583 ss. describitur, ubi equites „alternos ... orbibus orbes impediunt.“  
(*labyrinthus*)



in vase Etrusco (Tragliatella) duo equites e labyrintho, qui „trua“ appellatur, egrediuntur

## tropaeum —i, n.

est monumentum a victore creatum in honorem deorum eo loci, ubi hostes in fugam vertit. Prima tropaea ex arboribus confecta sunt, quas amputatis minoribus ramis hostium spoliis (*spolium*) ornabant.



arbor in tropaeum versa

## trua —ae, f. demin. trulla

trua est vasis genus planum, foraminibus instructum ad spumam adimendam vel miscendum extrahendumve aliquid ex aquis.



## turbo —inis, m.

turbo dicitur quicquid in *gyrum* vertitur, circumagitur.

a) speciatim est ventus vorticosus et validissimus, qui obvia quaeque prosternit, et ipse *vertex*, quem ventus efficit.

*Seneca*, *quaest. nat.* 5, 13, 3:

„ventus circumactus et eundem circumambiens locum et se ipse vertigine concitans, turbo est.“

b) genus instrumenti lusorii, nempe lignum formā *metae inversae*, ima sui parte in acutum desinens, in summo latius, quod a pueris *scuticā* vel *clave* circumagitur. (*ludus*)

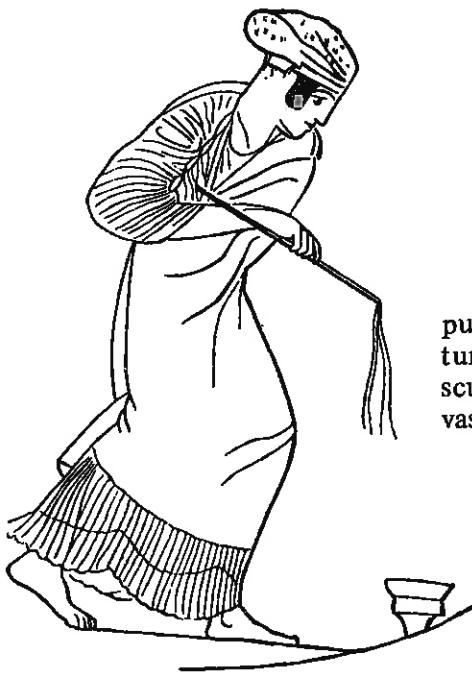

puella Attica  
turbinem agitans  
scuticā. imago  
vasis Graeci

### turibulum -i, n.

turibulum est vas, in quo tus odoris divulgandi causā crematur (Graece thymiaterion).  
tus, turis, n. (vel thus, thuris) est lacrima exiguae arboris in Arabiā, quae siccata adoletur in sacris.

Evangelium secundum Matthaeum 2, 11:

„(Magi) intrantes domum invenerunt puerum cum Maria matre eius et procidentes adoraverunt eum et apertis thesauris suis obtulerunt ei munera, aurum, thus et myrrham.“

Livius, 29, 14, 13:

„turibulis ante ianuas positis ... atque accensore precantibus, ut ...“

Curtius, 8, 9, 23:

„cum rex (Indiae) se in publico conspici patitur, turibula argentea ministri ferunt totumque iter, per quod ferri destinavit, odoribus complent.“

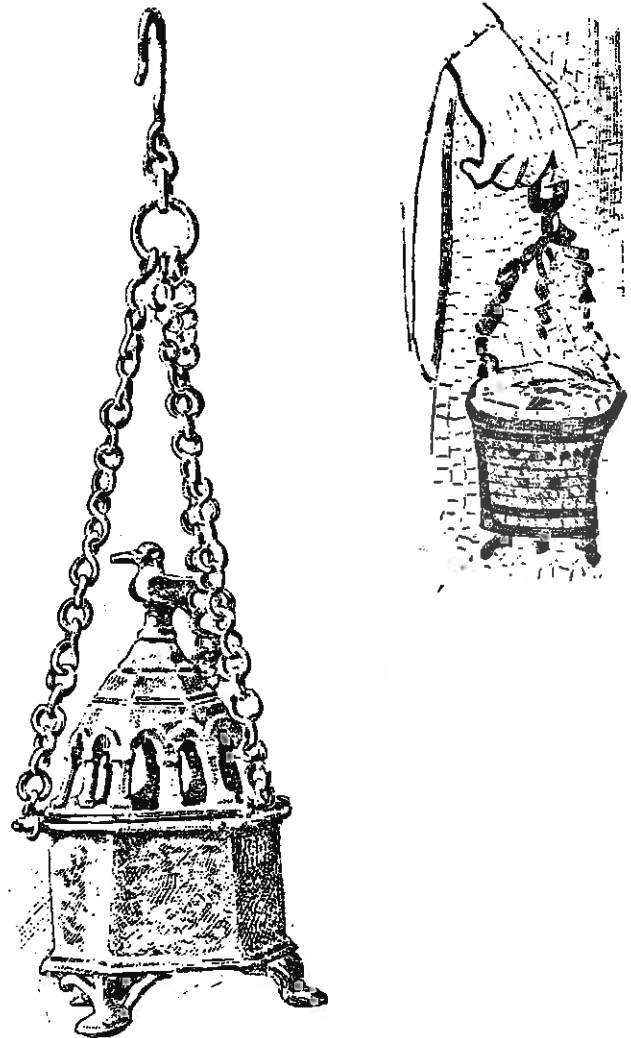

### turris -is, abl. turri, acc. turrim, f.

turris est aedificium in magnam altitudinem protensum, alta moles.

turris aequa cum muro est urbis *propugnaculum*.

turris vocatur etiam machina bellica, aedificium ligneum, in magnam altitudinem erectum subiectisque rotis huc illuc mobile.

adi. turrītus: turribus instructus.

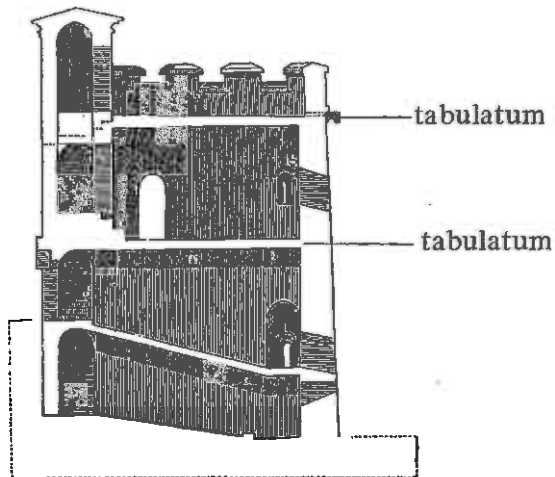

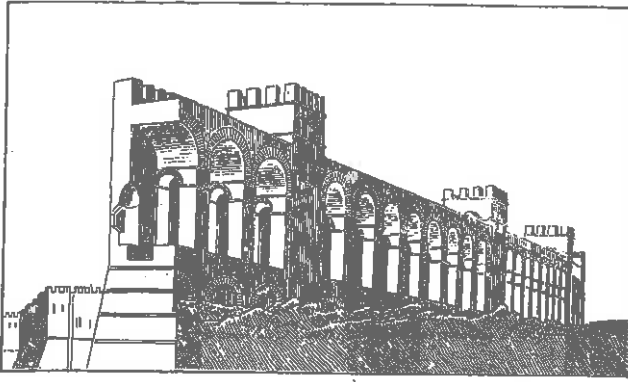

turres in moenibus Pompeianis

**tutela** –ae, f.

est defensio, praesidium, patrocinium; nomen actionis verbi tueor, tuitus sum, tueri.

Plautus, Trin. 870:

„ecquis his foribus tutelam gerit? “

Suetonius, Aug. 49, 1:

„classem Miseni et alteram Ravennae ad tutelam Superi et Inferi maris collocavit.“ (*classarius*)

Dea Tutela cum cornu copiae repraesentatur.



tutela navis est numinis (dei) *signum* in *puppi navis*, unde praesidium navigantibus sperabatur. (*insigne*)

dei tutelares dicuntur, in quorum tutelā urbes et loca sunt.



**tympa-num** –i, n.

a) est instrumentum vocalē, quod digitis palmā-que pulsando sonum edit.



b) tympa-num etiam dicitur a similitudine *rota plaustr*, *rota*, quae calcando vertitur, membrum in architecturā, spatium triangulare sub fastigio templi.

tympa-nistria saltatrix est, quae tympanum digi-tis pulsatis.



tympa-nistria

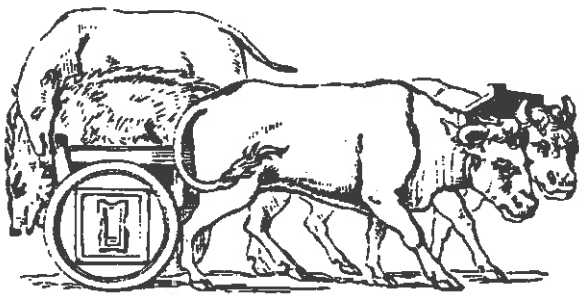

tympanum plaustrum

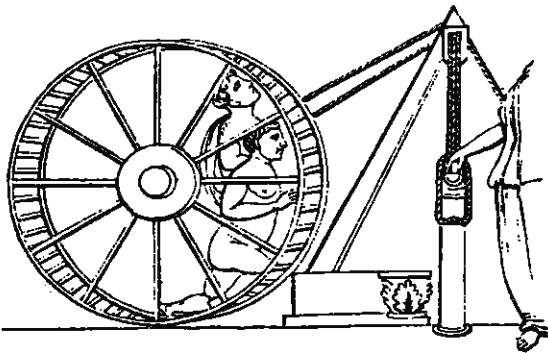

tympanum machinae elevatoriae

c) est triangulum sub fastigio (*fastigium*) templi, statuis vel opere caelato exornatum.



tympanum templi Athenae antiqui



tympanum supra porticum ecclesiae cuiusdam Medii Aevi, maiestatem Domini cum quattuor symbolis evangelistarum perhibens. (*maiestas domini, symbolum*)

\*\*\**typographia* -ae, f.

*ars impressoria* a Iohanne Gutenberg circiter anno 1440 Maguntiae inventa est. *typos aeneos* mobiles excogitavit, quos *typotheta* in verba composuit. post *impressionem* iidem typi aenei iterum in alia verba componebantur. His fere verbis Iohannes Amos Comenius in suo libro „Orbis Sensualium Pictus“ denominato opus typographicum describit (*xylographia* XVI. saeculi officinam typographi illustrans):

„*typographus* habet aeneos typos magno numero distributos per loculamenta (1), *typotheta* (2) eximit illos singulatim et componit [secundum *exemplar*, quod *retinaculo* (3) sibi praefixum habet] verba *gnomone* (4) donec fiat *versus*; hos indit formae (5) donec fiat *pagina* eosque coartat marginibus ferreis (6) ne dilabantur; ac subicit prelo (7). tum *impressor* ope *pilarum* (8) illinit atramento *impressorio*, superimponit inditas *operculo* (9) *chartas*, subditas *trochleae* (10) *sucula* (11) impressas facit typos imbibere.“

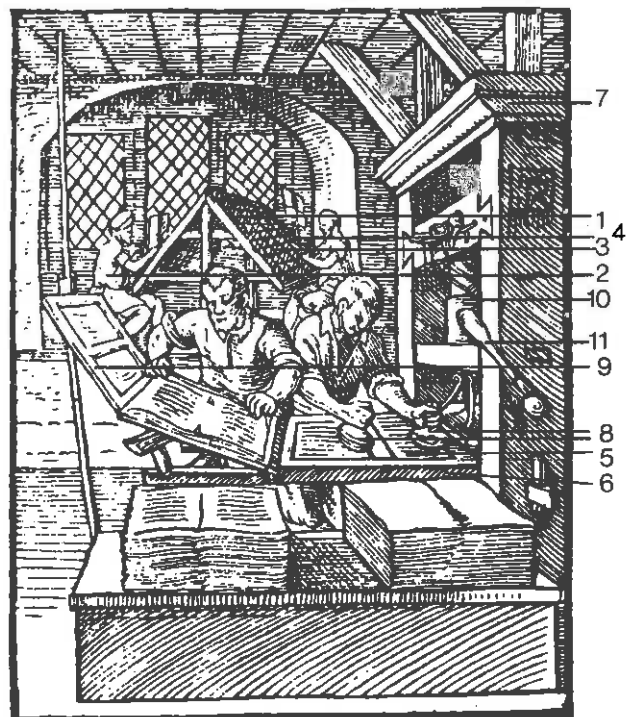

- 1) loculamenta 2) typotheta 3) retinaculum
- 4) gnomon 5) forma 6) margo ferreus
- 7) prelum 8) pilae 9) operculum 10) trochlea
- 11) sucula

## typus -i, m.

(Gr.) *nota, signum*, forma percutiendo seu pulsando impressa, ut *vestigium* humi pede impressum.

typus etiam idem est quod ectypum: opus caelatum.

\*\*typus apud scriptores ecclesiasticos: typi dicuntur figurae rerum seu personarum, quae in Novo Testamento futurae erant.

Ambrosius, 3 de David 11, n. 89:

„ille (Melchisedech) in typo, hic (Christus) in veritate: typus autem est umbra veritatis.“

\*\*\*a temporibus Gutenbergi typis aeneis libri, *acta diurna* aliaque imprimuntur: ars typographica vel *typographia*.

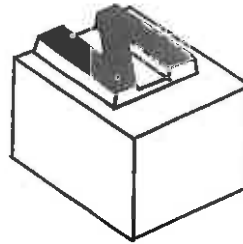

typus aeneus

## umbilicus –i, m.

a) est regio media alvi et abdominis, cavitate quadam praedita, vestigia servans vasorum, per quae fetus, dum est in utero matris, nutritur.  
b) a similitudine umbilicus dicitur media pars cuiusque rei, ex. gr. locus terrae:

Cicero, Verr. 4, 48, 106:

„qui locus, quod in media est insula situs, umbilicus Siciliae nominatur.“

etiam Delphi umbilicus terrae dicuntur.

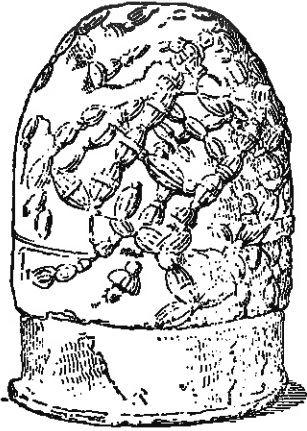

umbilicus Delphorum

## umbo –onis, m.

a) umbo est quidquid in plano rotundā aut coni figurā exstat ac prominet; speciatim dicitur sic media pars clipei eminentior.

b) umbo et ipse clipeus nominatur.

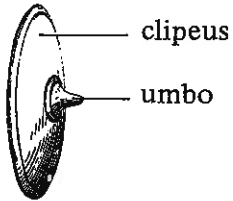

c) latiore sensu a similitudine, umbo dicitur quidquid prominet et protenditur ac aliquid protegit, ut lapides in margine crepidinis. (crepido)

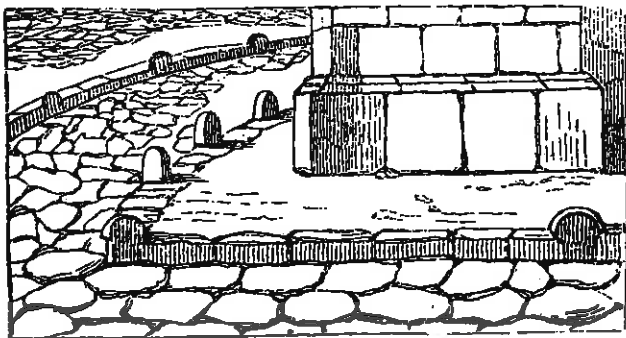

umbones in margine viae

## umbraculum –i, n.

a) est locus, in quo est umbra, locus compositus et tectus frondibus aut alia re quacumque ad umbram praebendam, tabernaculum velumve umbrae causā erectum.

b) sumitur quoque pro umbrella, qua tegitur facies ad solis calores arcendos.



## unguentum –i, n.

est omnis sucus pinguis, quo unguimur deliciarum et luxūs causā.

Plautus, Mostellaria 41:

„non omnes possunt olēre unguenta exotica.“

unguentarius, –i, m.

est homo, qui unguenta conficit et vendit.

Seneca, quaest. nat. 4b 13, 8:

„unguentarios Lacedaemonii urbe expulerunt et propeere cedere finibus suis iusserunt, quia oleum disperderent.“

unguentarium (sc. vas)

e vitro aut alabastro factum

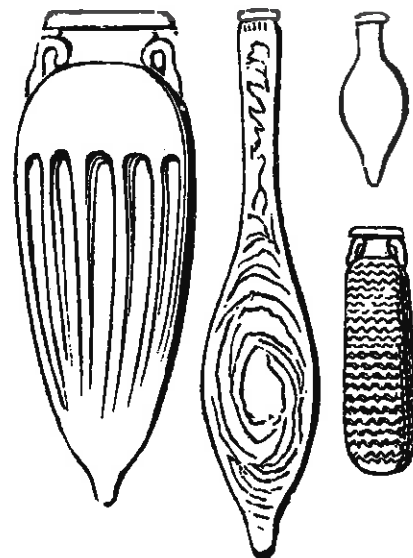

vasa unguentaria



## urceus —i, m.

est vas ansatum, plerumque fictile ad varios usus et praecipue ad ministrandam aquam. (*ansa*).

adverbium: urceatim:

Petronius, sat. 44, 18:

„Iovem aquam exorabant, itaque statim urceatim pluebat.“

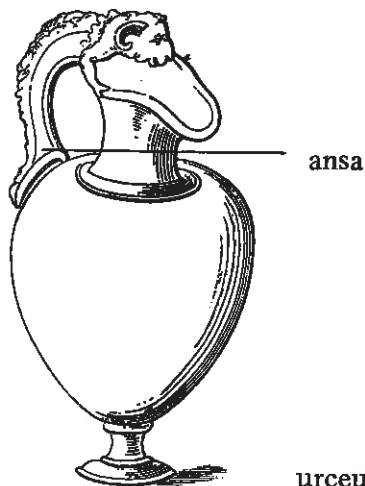

## urna —ae, f.

est vas, quo aqua e puteis (*puteus*) fluminibusque hauritur.

ansulis instructum erat, ut pro more umeris vel capite gestaretur.

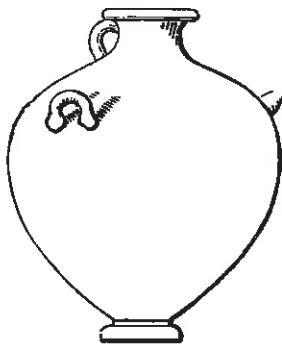

## utensilia —ium, n. pl.

dicuntur quaecumque usui nostro sunt necessaria.

Columella, r. r. 12, praef. 3:

„utensilia, quibus aut aliter hominum genus aut etiam excolitur.“

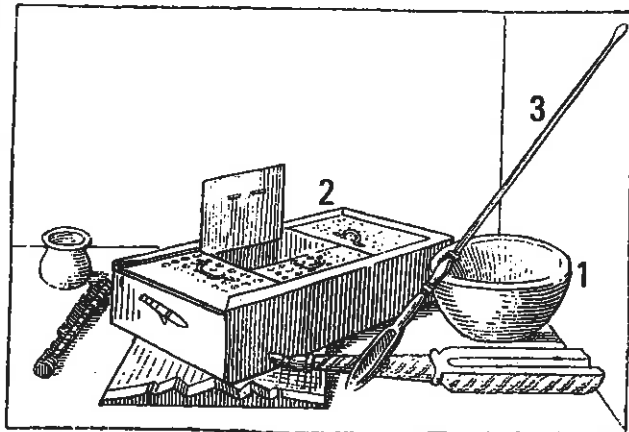

in imagine depicta sunt utensilia *pictoris*: mortarium (1), in quo colores teruntur, scrinium colorum (2), penicilli (3)

## uter —tris, m.

est pellis, qua vinum aut oleum aut alia quaequam similis res deferri solet.

Petronius, sat. 34, 4:

„intraverunt duo Aethiopes capillati cum pusillis utribus, quales solent esse qui harenam in amphitheatro (*amphitheatrum*) spargunt, vinumque dedere in manus ...“

utre uncto in lusu utebantur:

Vergilius, Georg. 2, 384:

„mollibus in pratis unctos saliere per utres.“ (vide imaginem!)

frequens fuit apud veteres utrium usus ad flumina trananda.

utrarii sunt qui exercitum sequentes aquam utribus ministrant.

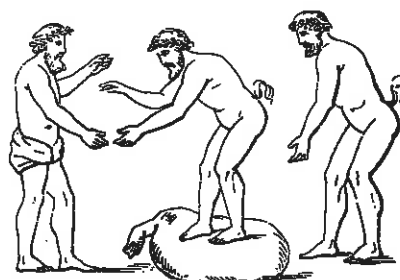

satyri utre uncto ludentes

**\*\*utopia** –ae. f:

est urbs „nullius loci“, quae nullum locum habet (Graece: u topon echei = non habet locum) i. e. quae nusquam terrarum est. hoc nomine Thomas Morus, scriptor Anglicus - Latinus, rem publicam optimis moribus atque institutis instructam appellavit, qua optimum civitatis statum nusquam perfectum monstraret.

\*\*exinde omnia, quae solum ideis, nondum operā perfecta sunt, „utopiae“ nominantur.

**Libellus vere aureus nec  
MINVS SALVTARIS QVAM FESTI-  
uus de optimo reip. statu, deq; noua Insula Vtopia  
authore clarissimo viro Thoma Moro in clytæ  
ciuitatis Londinensis ciue & viccomite cu-  
ra M. Petri Aegidii Antuerpiensis, & arte  
Theodorici Martini Aluſtensis, Ty-  
pographi almæ Louanicensium  
Academix nunc primum  
accuratissime edi-  
tus, .f.**

**utricularius** –i, m.

a) utricularius est qui utriculos seu utres inflatos ratibus ita subiiciebat, ut iisdem flumina transnare possent. horum opificum collegium in quibusdam urbibus ad flumen aliquod situs habebatur. ideoque saepe utricularii cum nautis coniunguntur. (*uter*)

b) utricularius est etiam qui canit tibiis paruo utri infixis, eum subinde inflando (= ascaules). (*instrumenta musica*).



utricularius

## vacuum –i, n.

vacuum spatium est locus inanis, vacuus omnis materiae.

Primus qui experimento spatium vacuum reddidit, fuit Otto de Guericke. *frontispicium* eius operis, quo experimenta sua exposuit duos globos vitreos monstrat, quorum superiorem *antiā pneumaticā* ad exhauriendum aërem aptā vacuum reddidit. ex inferiore postea aqua pondere aëris pressa in superiorem aere vacantem siphonis (*sipho*) modo ascendit.

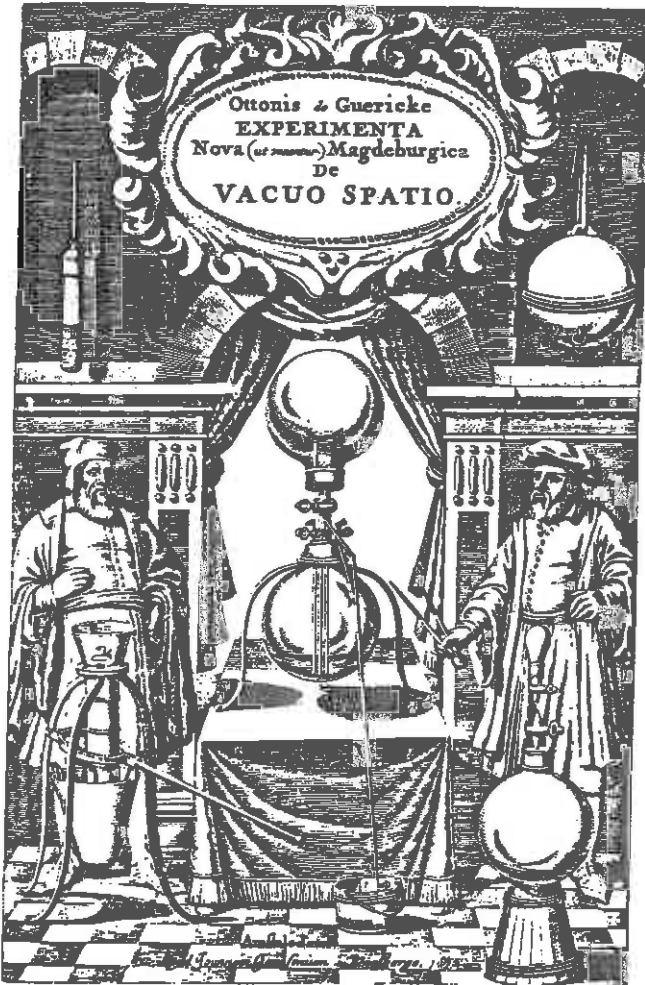

## vadum –i, n.

est locus in mari aut flumine, ubi aqua brevis est et pedibus transiri potest.

Caesar, B. G. 1, 6, 2:

„Rhodanus ... nonnullis locis vado transitur.“

translate: in vado esse = in tuto esse.

res est in vado salutis = res iam salva est.

## vagīna –ae, f.

vagina est theca gladii, involucrum.

Cicero, de inv. 2, 4, 14:

„gladium ... e vaginā eduxit, ... gladium cruentatum in vaginam recondidit.“

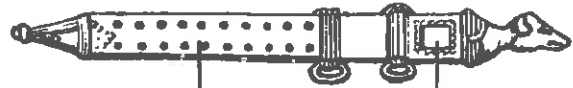

vaginā

capūlus

## valvae –arum, f. pl.

valvae sunt lignae fores, ex duabus aut tribus aut pluribus etiam tabulis, quibus ianua aut fenestra aut *armarium* clauditur.

Ovidius, met. 2, 4:

„argenti biformes radiabant lumine valvae.“

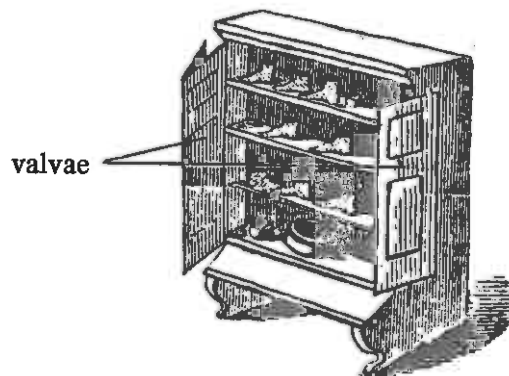

valvae

## vannus –i, f.

vannus est *cribrum* cereale, instrumentum latum ex vimine, quo acus paleaeque post trituram (*tribulum*) a frumento aut legumine ventilando et in sublime eiiculando excernuntur.

Columella, r. r. 2, 20, 4:

„ipsae autem spicae melius fustibus tunduntur, vannisque expurgantur.“



Vergilius, Georg. 1, 166:

„... et mystica vannus Iacchi.“

Servius ad locum:

„mystica, quod Liberi Patris sacra ad purgationem animae pertinebant: et sic homines eius mysteriis purgabantur, sicut vannis frumenta purgantur.“

## vates —is, m.

est sacerdos (m. et f.) dei voluntatem hominibus nuntians.

saepe etiam poeta a deo instinctus vates vocatur.

verbum: vaticinor, —ari.

subst. verbale: vaticinatio.

proverb.: „vaticinium ex eventu“, est vaticinatio falsa, quae post eventum profertur.



tripus laurus

imago e vase Graeco, hodie deperdito (e coll. Hamilton) deum Apollinem in tripode (*tripus*) vaticinantem monstrat, manu sinistrā arcum, manu dextrā patellam tenentem

## vellus aureum

vellus, —eris, n.

a) lana ex ove dempta et conglobata.

b) de ipsis lanatis ovium pellibus; vellus aureum est vellus eius arietis, qui Phrixum (*Phrixus*) et Hellen supra mare portavit.

Argonautae (*Argo*) duce Iasone vellus aureum a dracone custoditum in Colchide quaerebant.

c) \*\*ordo velleris aurei erat ordo equitum a ducibus Burgundionum instauratus.

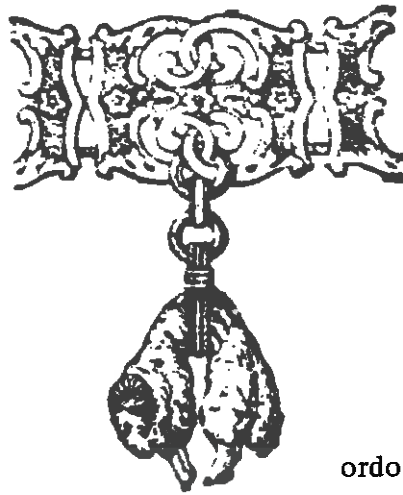

ordo Velleris Aurei

## velum —i, n.

a) est linteum in mālo *navis*, quod expansum ventos excipit et navem impellit.

b) est linteum, pannus, aulaeum ad quidpiam tegendum, exempli gratia velum theatri umbram spectatoribus praebens.

velum in amphitheatro Pompeiano

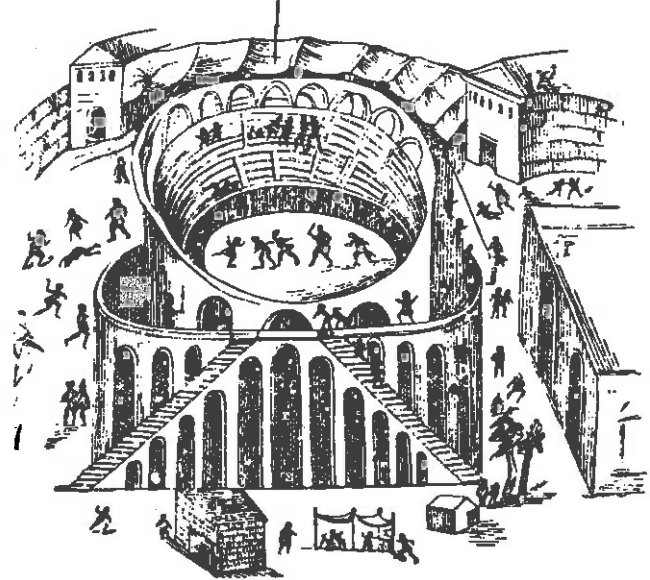

## venatio —onis, f.

est ferarum persecutio; a verbo „venari 1“.

venator est qui bestias feras sagitta, pilo, *funda* aut etiam *fovea* aut retibus (*rete*) persequitur. dea venatrix apud Romanos erat Diana.

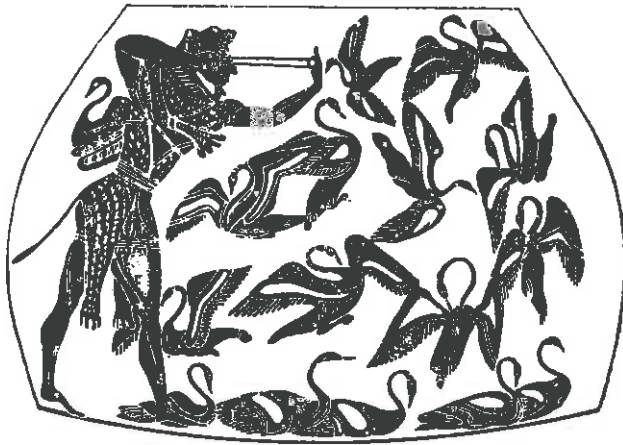

Hercules fundā aves Stymphalias venatur in vase Graeco picto

**ventus -i, m.**

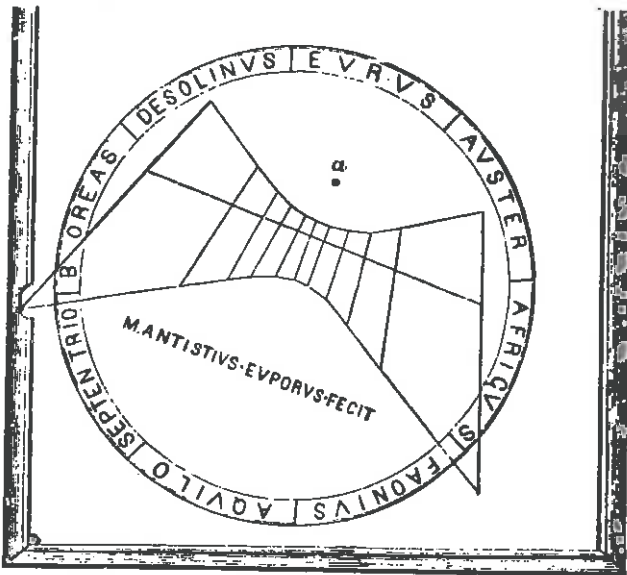

est aeris concitati motus, fluctus aeris impetuosior.  
 imago nostra *horologium* solare Aquileiae inventum monstrat, ubi octo venti distinguuntur: Eurus, Auster, Africus, Favonius, Aquilo, Septentrio, Boreas, Desolinus.  
formulae: „*ventis dare vela*“.  
*ventus secundus* et ferens est ventus, qui cum cursu nostro flat, *ventus adversus*, qui contra nos flat. hinc: res secundae, res adversae.

ventus secundus

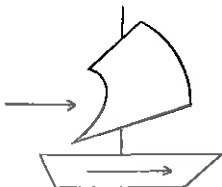

ventus adversus

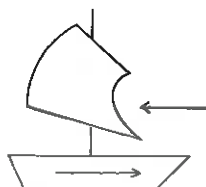

**vertex -icis, m. (vel vortex, -icis m.)**

vertex est universim id, quod vertitur, itemque id, circa quod aliquid vertitur.

Quintilianus, 8, 2, 7:

„ut vertex est contorta in se aqua (*gurges*) vel quidquid aliud similiter vertitur: inde propter flexum capillorum, pars est summa capitis: et ex hoc, id, quod in montibus eminentissimum.“

vertex:

- a) contorta in se aqua.
- b) flexus capillorum in summo capite = summum caput.
- c) summus mons.

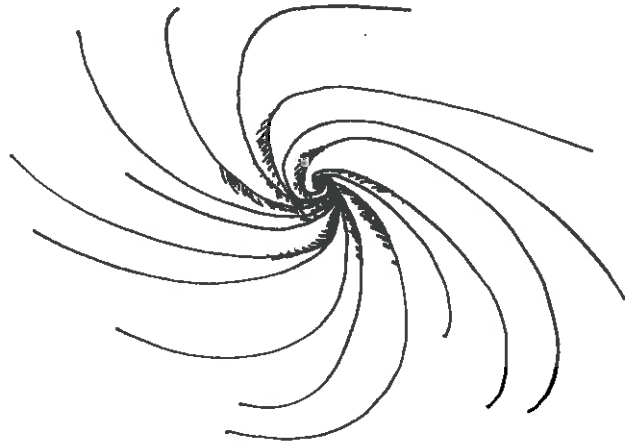

**veru -us, n.**

veru est instrumentum ferreum aut ligneum oblongum cuspidatum, cui infinguntur carnes igni torrendae. (*crates*)



cuspis

## vespertilio —onis, m.

a) est animal volatile, mediae cuiusdam inter avem et murem speciei, ut mus ālātus dici possit.  
b) translate vespertilioes vocantur lucifugae, i. e. qui noctu demum vespertilionum more prodeunt in publicum, ut ex. gr. qui aere alieno (aes alienum) obruti interdium domi delitescunt, metu creditorum.

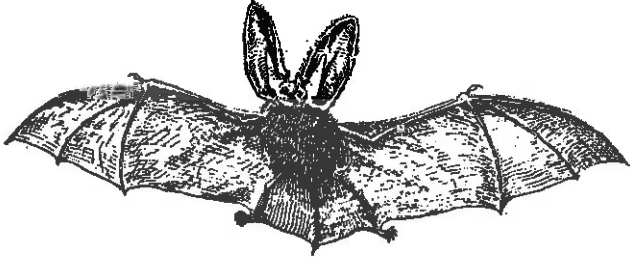

## Vesta, Lares, Penates

Lares (lar, —aris, m.) erant vicorum atque itinerum dei et tectorum domuumque custodes. (Arnobius, 3, 41).

et Penates dei tutelares domus sunt.

Lares tamquam feles semper eodem loco manent, Penates cum hominibus coniuncti sunt ut canes, qui dominum sequuntur.

Vesta dea focum domus repraesentat.

Penates homines comitantur cum e terra sua emigrant.



in imagine Pompeiis reperta videmus deam Vestam in solio sedentem, dextra manu pateram tenet, sinistra cornu plenitudinis (cornu copiae). post eam est asinus, bestia Vestae attributa. Iuvenes caput frondibus coronati Lares sunt. e cornibus aquam aut vinum in vas fundunt. in aliis imaginibus saepe circum Vestam saltant.

## Vestalis —is, f.

Vesta est dea foci; forma eius templi est circularis. erat ibi ignis, qui perpetuo servabatur a virginibus Vestalibus. Vestales virgines institutae sunt a rege Numa, quattuor numero; postea numerus earum auctus est. votum virginitatis strictissime eis servandum erat. privilegiis atque honoribus donabantur. cum enim exhibent, licitor praecedebat cum securi fascibusque. (miles Romanus).

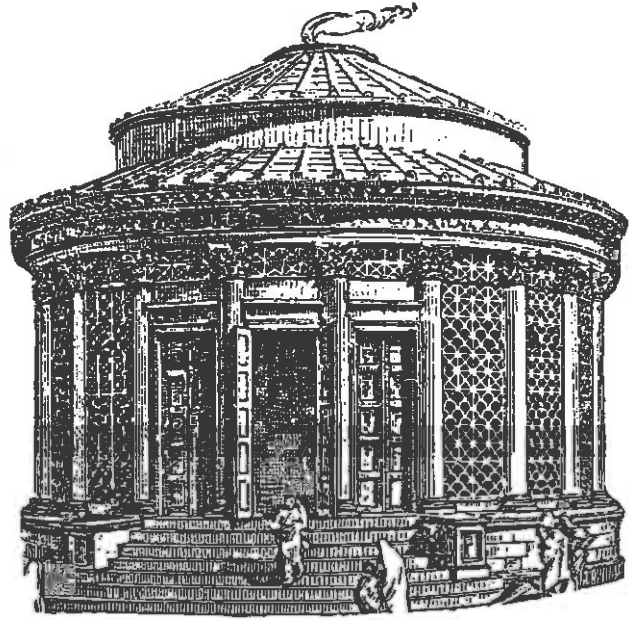

templum rotundum Vestae (reconstr.) quod dicitur

**vestiarius** —i, m.

est mercator pannorum vestiumque ut opus caelatum monstrat, quod officinam aut tabernam vestiarii repraesentat.

**vestiarium**, —i, n.

est locus, ubi vestes aliaeque res reponuntur. (officina, taberna)



**vestibulum** —i, n.

est locus ante aedium ianuam, inter aedes ipsas et viam relictus, eum in usum, ut qui aedium dominum salutatum venissent, neque in via starent neque in ipsius essent aedibus. (domus Romana)

**vestigium** —ii, n.

est signum, quod a pede in terrā relinquitur. **formula dicendi:** vestigia flectere ad locum: eo pedibus ire. **verbum denominativum:** investigare = per vestigia quaerere, vestigiis insequi et deprehendere.



vestigia pedum in tabulā votivā (votum)

Cicero, nat. deor. 2, 63, 158:

„canum ... tam incredibilis ad investigandum sagacitas narium (nares)“

**vestimenta Romana**

vestimenta virorum

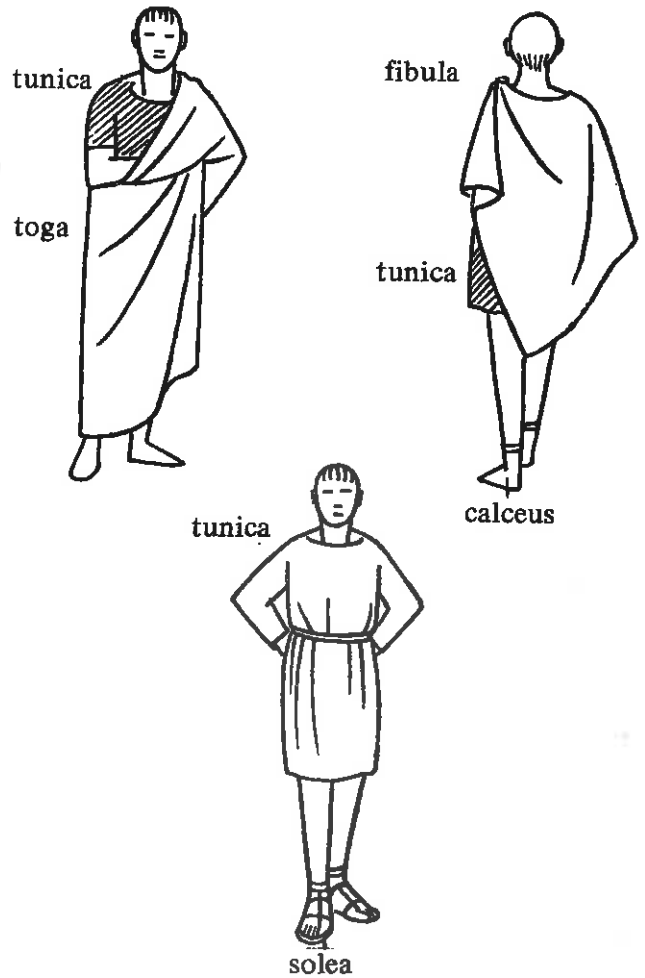

vestimenta mulierum

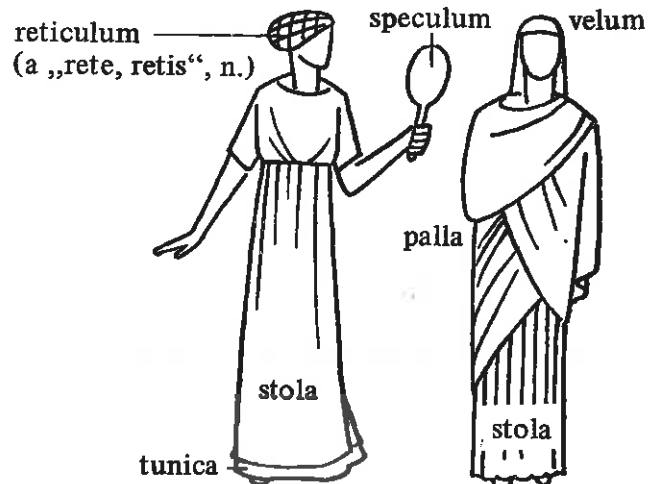

**vexillum** —i, n.

est *signum*, praecipue in usu militum. „vexillum“ ponitur interdum pro manu militum sub uno vexillo.

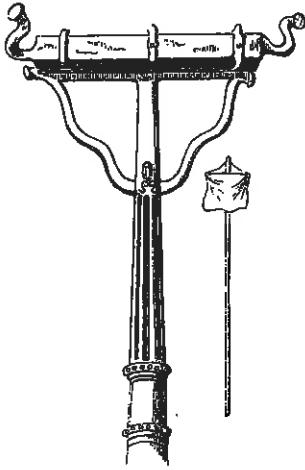

**via** —ae, f.

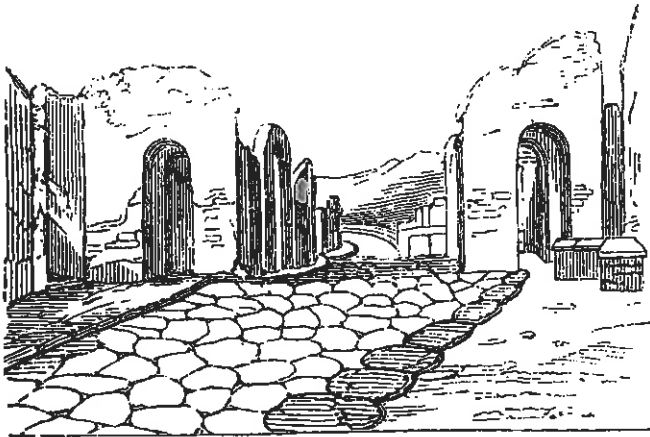

est quivis locus, qua vehiculo seu pedibus seu alia quacumque ratione ire licet. aliae viae ab auctoribus appellatae sunt, ut via Appia ab Appio Claudio Caeco censore, aliae ab urbibus, ad quas ferebant, ut via Collatina, aliae a provinciis, ut Campana aut Latina, aliae a diversis eventibus, ut via Triumphalis, etc.

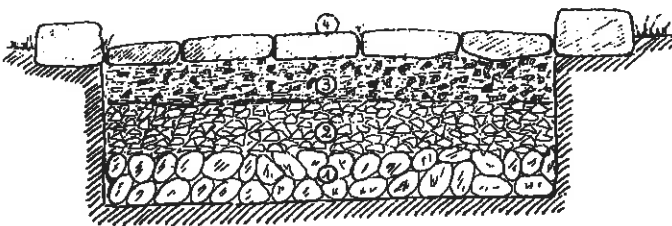

- 1 statumen     3 nucleus
- 2 rudus        4 pavimentum (stratum)

viae publicae a Romanis admirabili magnificentia non in Urbe solum, sed etiam tota Italia factae et stratae fuerunt; creati sunt (post aediles) proprii magistratus, qui „viarum curandarum“ et „curatores viarum“ vocabantur. in viis constitutae fuerunt columnae lapideae, quae singulis intervallis positae signum miliariorum (*miliarium*) prae se ferebant. viae silicibus (*silix*) planis stratae erant, e quo Germanice „Strasse“, Anglice „street“, Italiane „strada“.

**Via Appia**

Via Appia anno 312 ante Ch. natum a censore Appio Claudio Caeco strata est. via praecipua Romae Capuam duxit, postea usque ad Brundisium extenta est. ante urbem Romam praeter viam Appiam sepulcra magnorum virorum erecta sunt, quae etiam hodie partim exstant.

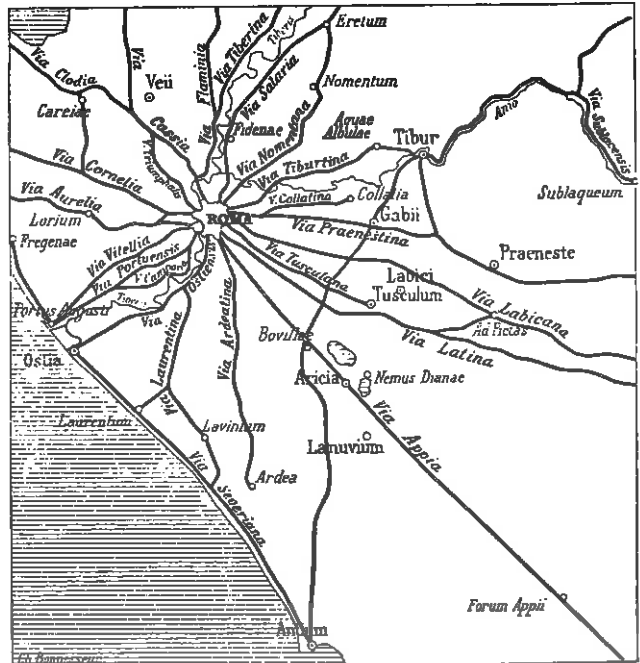

nomina viarum quae Romae incipiunt

**viator** —oris, m.

est qui iter facit. viator etiam est minister publicus: viatoribus utebantur magistratus ii, qui potestatem, non imperium, habebant, cuiusmodi fuerunt censores et tribuni plebis; at viatoribus et lictoribus (*lictor*) simul, qui imperium habebant, ut consul, dictator, proconsul in provincia.





viator cum *cuculla*  
e fonte (*fons*)  
aquam hauriens.

## vigiles, vigiliae

*vigil* (-is) est is, qui vigilat, qui non dormit.  
*vigiles* sunt excubitores nocturnique custodes.  
*vigilia*, -ae, f. est vigilatio, insomnia. in re  
militari *vigilia* dicitur, quae fit a militibus custo-  
diendi causā.

vigiliae militares quattuor erant, prima, secunda,  
tertia, quarta. singulae tribus horis constabant.  
noctes in duodecim horas dividebantur, quae  
aestivo tempore breviores, hiemali tempore  
autem longiores erant. (*dies*)

Hieronimus, ep. 140, n. 8, 2:

„nox in quattuor vigiliis dividitur, quae singulae  
trium horarum spatio supputantur ...“



imago vigiliae militaris ex Aeneide Vaticanā  
sumpta.

## villa rustica

et res, quae simul cum vocabulis Latinis a  
Germanis receptae sunt:

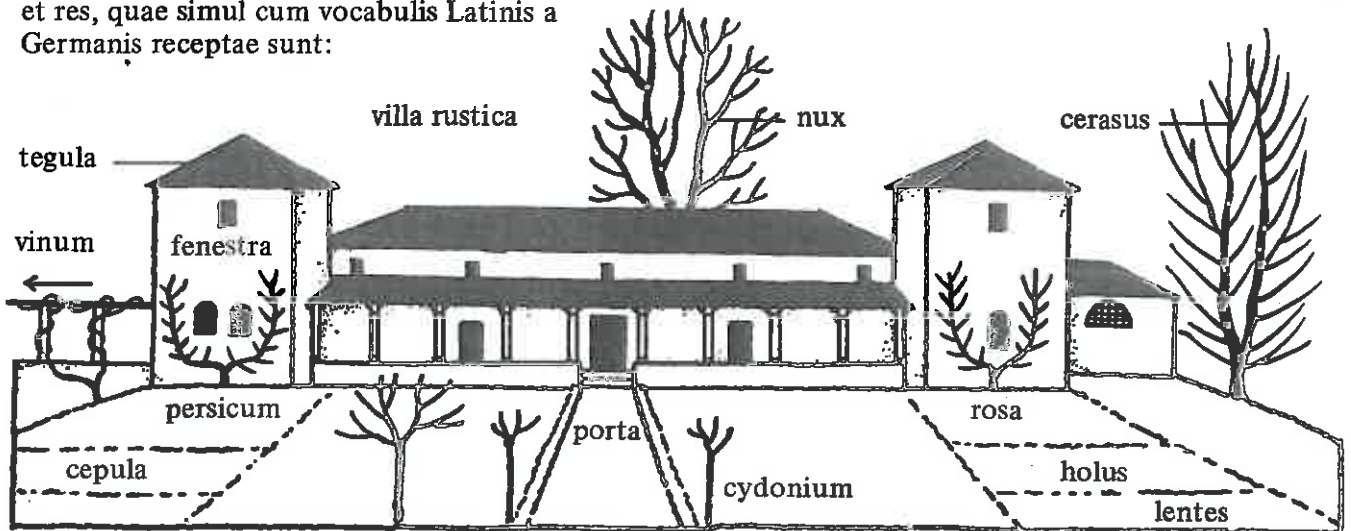

### in campo:

#### arbor

cerasus, f.  
cydonia, f.  
buxus, f.  
prunus, f.  
nux, f.

#### fructus

cerasum  
cydonium  
prunum  
nux, -cis, f.

### in horto:

vinum, vindemia,  
rosa, persicum,  
lens, lentis, f.  
holus, -eris, n.  
cepa, cepula

### in re aedificatoria:

calx, -cis, f.  
tegula, -ae, f.  
spicarium, -i, n.  
cellarium, -i, n.  
vallum, -i, n.  
mortarium, -i, n.  
fenestra, -ae, f.  
coquina, -ae, f.  
solarium, -i, n.  
pilare, -ris, n.  
murus, -i, m.  
porta, -ae, f.  
caminus, -i, m.  
camera, -ae, f.

Aliquot res sine nominibus Latinis in Germaniam introductae sunt a Romanis, ut lycopersicum, faba, pisum.

## vitta –ae, f.

a) vitta est ligamentum, fascia, cingulum, quo antiqui aliquid religabant.

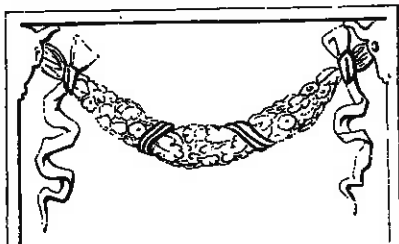

b) vitta est fascia, qua *arae* ornabantur et *hostiae*.  
c) vitta est ligamentum capitis, quo antiqui crines cingebant colligebantque, et quod etiam adhibebatur in sacris.



vitta

## volsella –ae, f.

volsella est instrumentum pilis e corpore radicitus evellendis idoneum; item ad varios chirurgorum usūs.

Plautus, *Curc.* 577:

„... volsellae, *pecten*, *speculum*, *calamistrum*“



## vomitorium –i, n.

in theatris (*theatrum*) et amphitheatris (*amphitheatrum*) erat ostium seu aditus, per quem populus ab internis porticibus (*porticus*) et scalis (*scala*) exibat in *gradus* et *sedilia*.

Macrobius, *Sat.* 6, 4, 4:

vomitoria „... unde homines glomeratim ingredienti in *sedilia* se fundunt.“

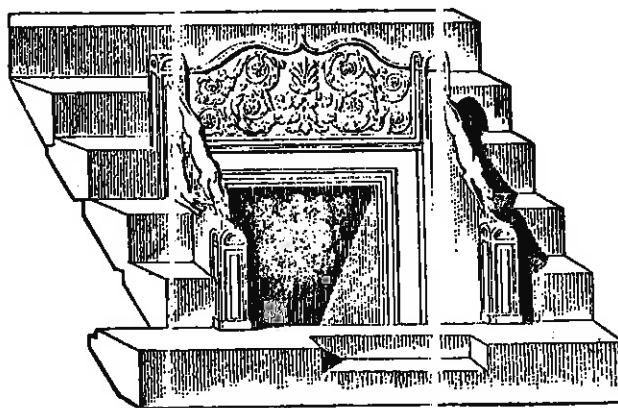

## Vulcanus –i, m.

a) fuit filius Iovis et Iunonis, qui a parentibus ob deformitatem caelo praecipitatus est deiectusque in Lemnum insulam. eā ruinā, quā decidit de caelo, claudus factus est. deus ignis et fabrorum praeses putatus est et fingitur etiam *faber* deorum, qui Iovi fulmina et ceteris deis arma adversus *Gigantes* fabricavit. officinam autem habere fertur in Lemno una cum *Cyclopi*bus ministris. *Venerem* uxorem duxit, quam cum postea una cum *Marte* deprehendisset in adulterio, ambos reti et invisibilibus catenis ita colligavit, ut neuter abire posset, donec ab omnibus deis deabusque visi et derisi sunt.

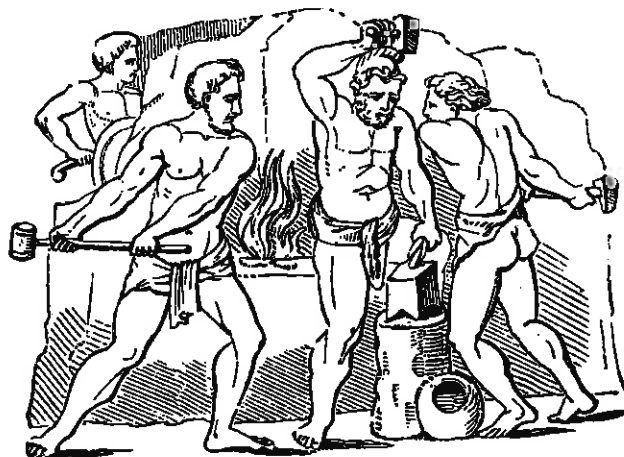

opus caelatum: Vulcanus ad *incudem* (*incus*) stans cum tribus *Cyclopi*bus *malleis* (*malleus*) ferrum tundit

*Vulcaniae insulae*, etiam *Aeoliae* nominantur. septem insulae sunt in mari Tyrrheno citra Siciliam sitae, quarum una est *Lipara*: omnium autem terra sulphurea est et ignem per intervalla evomens: inde fabulantur, ibi esse *Vulcani* officinam.

b) Vulcanus etiam metonymice de igne dicitur. Plautus, Amph. 341: „quo ambulas tu, qui Vulcanum in cornu conclusum geris? “

h. e. ignem geris in *laterna* cornea.

c) \*\*Vulcani etiam montes ignivomi nominabantur, ut Aetna, Vesuvius.



vulnus –eris, n.

vulnus est patens apertura in corpore ex ictu aut morsu.

Caesar, B. G. 1, 25:

„(Helvetii) vulneribus defessi pedem referre coeperunt.“

sanando vulnus ad cicatricem (cicatrix) perducitur, cicatrix –icis, f. est signum, quod sanato vulnere haeret in corpore.



imago sumpta est e „Chirurgia“ Conradi Gessner Turicensis

**\*\*xylographia**

e prima Utopiae editione sumpta, quae insulam Utopiam a Thoma Moro inventam monstrat (*utopia*).



imago titulum primae editionis (Lovanii 1516) praebet; Petrus Aegidius editor, Theodoricus Martinus impressor (typographus) fuit.

**zodiacus** —i, m.

haec imago est descriptio anni e codice conventus Sanctgallensis sumpta. monachus quidam Sanctgallensis saeculo nono post Christum natum annum duodecim signis zodiaci distin-

xit. usus est signis, quae iam antiquis temporibus inventa sunt. zodiacus est circulus eorum signorum stellarum, quae sol uno anno percurrit. (*balteus*)



**zona** —ae, f.

Gr. *zōnē* = cingulum.

- a) zona est vinculum, quo cingimur: cinctus, *balteus*.
- b) zonae dicuntur circuli quidam lati, caelum terramque veluti cingula quaedam ambientes. sunt autem numero quinque, ex quibus media, quae inter tropicos est, nimio calore, parum apta habitationi credita fuit; quae vero extremae sub Arctico et Antartico circulis sitae, nimio frigore horrent: unde et ipsae inhabitabiles habitae sunt. reliquae autem, ut quae medium inter torridam et gelidam situm obtinent, temperatae sunt, humanae vitae accommodatissimae.

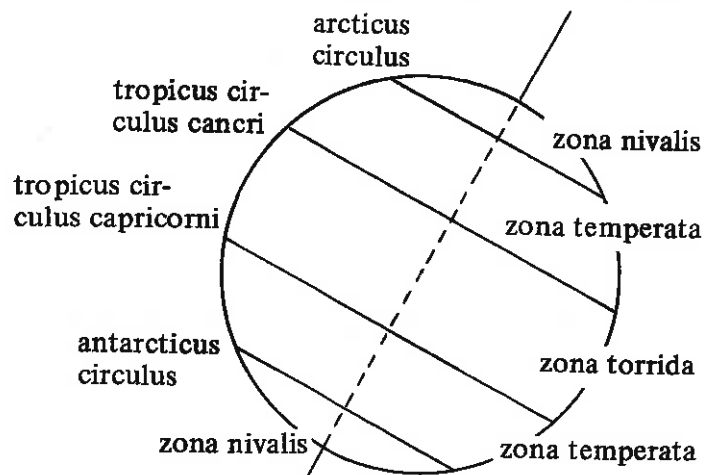

- A**  
abacus 1  
 abdomen 471  
acanthus 2  
 Acer platanoides 176  
 acerra 385  
acetabulum 3  
 acetum 3  
 Acheron 95  
 acia 6  
acies 3  
aconitum 3  
acroterium 4  
acta diurna 5  
 actor 338  
 aculeus 295  
acus 6  
 adolescens 11  
adorans 7  
 ad perpendicularum 337  
 adverbia loci 264  
 aedes publicae 59  
aedicula 7, 247  
 aedificium 190  
 aedilis 488  
 aeditumus 9  
aedituus 9  
 Aegaeus 313  
aegis 9  
 aequinoctium 143, 411, 435  
 aequinoctium autumnale 412  
 aequinoctium vernum 411  
 aequipondium 259  
aequitas 10  
 aer 155  
 aes alienum 483  
Aesculapius 10  
 aestas 223  
aetates hominis 11  
affinitas 11  
 Africa 314  
 Africus 481  
 Agenor 160  
 agger 261  
agitator 13, 67  
 agitator aselli 13  
 agri cultura 456  
 agri mensor 277  
 ala 151, 247  
 albogalerus 385  
album 14  
 albumen 318  
 alga 297  
allocutio 14  
 Alsatia 309  
 altare 31, 207  
 alticinctus 15, 96  
alvearium 15  
alveus 15  
ambo 16  
 amita 107  
 amphibium 375  
 amphiprostylos 435  
amphitheatrum 17  
amphora 17, 351, 425  
ampulla 18, 425, 448  
 amurca 311  
ancora 19, 26  
Anglia 19  
 angulus 203  
 angulus acutus 204  
 angulus curvilineus 204  
 angulus mixtus 204  
 angulus obtusus 203  
 angulus rectilineus 204  
 angulus rectus 203  
annona 20  
annus 20  
ansa 21, 17, 410, 473  
 ansa crepidae 22  
 ansa gubernaculi 21  
 ansa ostii 22  
 ansa staterae 21  
 anser 272  
antae 22  
 antarcticus 399  
 antediluvianus 144  
antefixum 23, 433  
 antelucanus 378  
 ante lucem 378  
 antemeridianus 378  
 ante meridiem 378  
 antenna 39  
antlia 23  
 antlia pneumatica 477  
 antrosum 372  
antrum 24  
 anularius 123  
 anulus 427  
 anulus signatorius 405  
 anus 12  
 apalare 131  
aper 24  
 apex 173, 385, 446  
 Aphrodite 135  
 apiarium 15  
apis operaria 25  
aplustre 25, 39  
 apodyterium 55  
Apollo 26  
 apotheca 310, 445  
apotheosis 27  
 apsis 60, 129, 327  
aqua 28  
aquaeductus 29  
 aquarius 242  
 Aquarius 498  
 aqua salutaris 387  
aquila 30  
 Aquilo 481  
 Aquilegia 364  
 aquilifer 286  
ara 31, 385  
arana 31  
 aratio 376  
 arator 32, 350  
aratrum 32  
arca 33  
 architectura 36, 79  
architectus 33  
 arcticus 399  
 Arctus 399  
arcus 35  
 arcus Iridis 273  
 arcus Titi 36  
area 37  
 arena 17  
argentarius 38  
 argilla cocta 440  
Argo 37  
 Argonautae 23, 342  
 aries 412  
 Aries 497  
 Arimaspi 212  
 arista 413  
 arithmetica 41  
 arma militum 285  
armamenta navis 39  
 armarium 258, 352, 411, 427, 478  
armilla 39  
 ars impressoria 468  
 ars mechanica 43  
 ars typographica 470  
artes, septem a. liberales 41  
artifices et artificia 43  
arx 47  
 arx Sancti Angeli 277  
as 47  
 ascaules 476  
ascia 47, 447  
 Asia 207, 314  
 asinus 104  
aspersio 48  
 aspersorium 49, 385  
 asser 216  
 Asterias rubens 364  
astragalus 49, 431

astronomia 41  
astronomus 277  
Atlantes 50  
Atlas 50  
atomus 50  
atramentarium 234, 258  
atramentum 236, 258, 276,  
385  
atrium 149, 247  
Atropos 329  
audire 399  
auditus 399  
augur 51  
augurium 51  
augurium adversum 52  
augurium prosperum 52  
aulaeum 480  
auricula 51  
auricularis 123  
aurifex 52, 46, 67  
auriga 12  
auris 51, 123, 399  
auritus 255  
Aurora 53  
auspicari 53  
auspiciu 53  
Auster 54, 481  
autumnus 223  
avena 54  
avena sativa 54  
aves Stymphaliae 481  
avia 197  
avis 30  
avis sacra 51  
avunculus 108  
avus 107  
axis 54, 381

## B

Baccha 446  
Bacchus 446  
baculum carbonis 346  
baculus 263  
baiulus 55  
balaena 55  
balneum 55  
balteus 56  
balteus equi 56  
balteus militaris 56  
balteus theatri 57  
balteus zodiaci 57  
baptisterium 58  
barbitum 234  
Barcino 234  
basilica 58, 129  
Bellerophontes 61  
Betula verrucosa 176  
biblia pauperum 61  
bibliographia 63  
bidens 63  
bigae 64

bigatus 64  
bilanx 244  
bipalium 63  
birotum 160  
bisellium 65  
bivium 460  
Boreas 481  
bos 67  
bovile 418  
bracae 65, 286  
bracchium 19, 124  
bractea 66  
bracteati 66  
Britannia 19  
bruma 411  
bubulcus 67  
bucina 68  
bucinator 68  
bucranium 385  
bulla 68, 434  
bulla aurea 69  
bullatus 70  
buris 32  
buxus 489  
Byzantium 69

## C

caccabus 425  
cadmia 346  
caduceus 71  
caducifer 71  
cadus 71  
caedere 72  
caelator 71, 45  
caelum 71  
calamister 72  
calamistratus 72  
calamistrum 72  
calamus 236  
calcar 72  
calcator 73  
calcatorium 73  
calceus 117, 123, 282, 410,  
427  
calco 73  
calculus 1  
caldarium 131, 226  
calendarium 73  
calidarium 55  
caliga 74  
calix 74  
Calliope 296  
calvaria 317  
calx 73, 124  
calx (mat.) 276, 490  
Camenae 26, 296  
camera 75, 490  
caminus 490  
Campania 75  
Campanula 364  
campi Elysii 460

campus 426  
canalis 77  
canalis semicircularis  
verticalis 52  
cancelli 77  
Cancer 411, 497  
candela 78, 249  
candelabrum 78  
canis venaticus 119  
canon 79  
canonica ratio 79  
canthus 373  
capillatus 449  
capillus 123, 449  
capistrum 79  
capitulum 80, 366  
capitulum Corinthium 81  
capitulum Doricum 80  
capitulum Ionicum 80  
Capricornus 411, 498  
capsa 81, 6  
capsa acuum 6  
capsula 81  
capulus 478  
caput 123, 302  
carbo 365  
carcer 81  
cardines portae 82  
cardo 82, 88  
cardo castrorum 83  
carina 83, 367  
Carnuntum 289  
caro 365  
carpentum 83  
cartilago 416  
Caryae 84  
Caryatides 84  
casa 84  
castellum 85  
castellum aquarum 86  
Castor et Pollux 85  
castra 87  
castra stativa 88  
castrum 422  
catacumba 87  
Catadupa 89  
catapulta 89  
cataracta 89  
catena 90  
catenarius 90  
cathedra 90  
cathedralis ecclesia 91  
catinus 129  
cauda 332  
caudex, codex 107  
caupo 91  
caupona Pompeiana 92  
cauponari 91  
causa 179  
cavea 92, 444  
Celeus 456

cella 93  
cella casearia 94  
cella farinaria 94  
cella lignaria 94  
cella olearia 94  
cella pomaria 94  
cellarium 490  
cella vinaria 73, 94  
cento 93  
centuria 94  
centurio 94  
cepa 489  
cepula 489  
cerasum 489  
cerasus 490  
cerebrum 316, 399  
Ceres 457  
cereus 191  
cernere 399  
cervical 95  
cervix 123, 316  
cestus 96  
Charon 95  
charta 257  
chimaera 95  
chorda 79  
choroides 309  
ciborium 96  
cicatrix 494  
cicurare 274  
cingulum 96, 286, 497  
circinus 97, 201, 305  
circulator 97  
circulus 205  
circulus antarcticus 498  
circulus arcticus 498  
circumferentia 373  
circus 97  
circus Maximus 97  
cirrus 99  
cisterna 99  
cithara 170, 233  
citharoedus 26, 296  
civilis 200  
classarius 100  
classis 100  
claustrum 101  
clava 101  
claviger 101  
clavis 102, 132, 461  
clavus 102, 212, 365  
clavus angustus 103  
clavus annalis 103  
clavus gubernaculi 103  
clavus latus 103  
clepsydra 224  
Clio 295  
clipeus 104, 285, 471  
clitellae 104  
clivus 426  
cloaca 105

cloaca Maxima 105  
Clotho 329  
cochlea 105  
cochlear 106, 131  
Cocytus 95  
codex 208, 257  
codex rescriptus 321  
codicillus 107  
coenobium 107  
coenobita 108  
cognatio 107  
cohors 107  
cohors praetoria 108  
collis 426  
collum 123, 315  
colonia 109  
colonia civilis 109  
colonia militaris 109  
colonus 109  
colum 109, 132  
columba 110  
columbarium 110  
columna 2, 278, 325, 345, 456  
colus 111  
commentarii diurni 5  
commercium 112  
communicatio 264  
commutatio 111  
comoedia 111, 338  
compedes 113  
compeditus 113  
compendium 113  
compitalia 113  
compitum 113  
compluvium 150, 247  
concha auriculae 51  
concha marina 459  
conclave 247  
concordia 114  
concupiscere 399  
congiarium 114  
congius 114  
consecratio 115  
consecratio Herculis 115  
consobrina 108  
consobrinus 108  
consonantes 316  
constratum 115, 365  
constratum navis 115  
constratum pontis 116  
consul 116  
consulatus 116  
contignatio 117  
contus 117  
conus 283, 398, 471  
convenientia 280  
conviva 118  
convivium 118  
copula 119  
coquina 131, 490

cor 124, 399  
corbis 119  
corbita 120  
corium 77, 125  
cornicen 120, 287  
cornu 39, 233, 287  
cornu copiae 465, 483  
cornu plenitudinis 483  
corona 121  
corona civica 121  
corona muralis 122  
corona navalis 122  
corona obsidionalis 121  
corona ovalis 121  
corona triumphalis 121  
corona vallaris 122  
corpus 302  
corpus humanum 123  
corrugia 123  
cortex 276, 318, 344  
cortina 124, 425  
Corylus avellana 175  
cos 125  
costa 317  
cothurnus 125  
cranium 440  
crates 126  
crates ferrea 126  
crena 335  
crepida 22, 427  
crepido 126  
crepido viae 126  
crepitaculum 127  
crepusculum 378  
creterra 132  
cribrum 127, 425  
crista 128, 198, 286  
crotala 235  
crus 124, 130  
crusta 395  
crypta 128  
crystallinus 310  
Ctesibica machina 129  
cubiculum 247  
cubile 253  
cubitum 124, 281  
cubus 439  
cuculla 130, 489  
cucullatus 130  
culcita 415, 453  
culex 130  
culina 131  
culmus 84  
culter 131, 33  
cultrarius 131  
cumululus 132  
cuna 229  
cuneus 132  
cuniculus 133, 255  
cupa 134  
cupella 425



Cupido 134  
Cupidines 135  
cupressetum 311  
cupula 425  
curator viarum 488  
curia 186  
currus 135  
currus alatus 136  
currus triumphalis 136  
currus volucris 136  
cursor 397  
cuspis 482  
cyathus 106, 131, 406  
cybernetica 212  
Cyclops 492  
cydonia 489  
cydonium 490  
cymba 219  
cymbala 233

## D

Dacia 323  
Daedalus et Icarus 137  
Dalmatia 323  
dalmatica 137  
Danaides 138  
Danaus 138  
dapifer 118  
declamatio 139  
declamare 139, 156  
decumanus 140, 88  
decursio 140  
defectio 139  
defectio lunae 140  
defectio solis 140  
defensor 333  
Delphi 141  
delphinus 53  
denarius 64  
dens 315, 317  
dentale 32  
dentales 316  
deorsum 372  
Desolinus 481  
dextrarum iunctio 306  
dextrorsum 7, 372  
diadema 141  
dialectica 460  
diametrus 206  
Diana 480  
diariorum venditor 5  
diatretum 142  
dies 143, 378  
digitale 143  
digiti manus 123  
digiti pedis 124  
digitis micare 284  
digitus index 123  
diluculum 378  
diluvianus 144  
diluvium 144

Dioscuri 85  
diptychum 145  
diptychum eburneum 146  
discus 104, 387  
discus colorum 342  
discus vitreus 447  
diurnarius scriptor 5  
diurnus 143, 378  
dividiculum 85  
divortium 147  
dolium 147, 425  
dolium Diogenis 147  
dolium fictile 148  
dolium pertusum 138  
domitor ferarum 247  
domus Romana 149  
donarium 153  
dorsum 123  
dos 416  
draco volans 266

## E

ebur 145  
ecclesia 456  
eclipsis 139  
ectypum 469  
educatio 155  
elementa 155  
elementarius 155  
ellipsis 155, 398  
ellychnium 177, 265  
emblema 156  
emporium 282  
ensis 286  
eo 264  
ephemeris 5  
ehippium 157  
episcopus 263  
epitonium 158  
epitonium electricum 158  
Epulones 253  
equile 418  
equus funalis 192  
equus iugalis 192  
eradicare 374  
Erato 296  
erinaceus 159  
essedarius 159  
essedum 160  
etesiae 160  
Eupalinus 133  
Europa 160, 314  
Eurus 481  
Euterpe 295  
evolvere 258  
examen 161  
exedra 161  
exemplar 342, 468  
exemplar mythicum 115  
exercitus 229  
exhedra 150

expiatio 315  
explicit 370  
expositio 162  
exsequium 406  
exta 216  
extrorsum 372  
ex voto 153

## F

faba 490  
faber 38, 421, 492  
faber aerarius 43  
fabula palliata 322  
fabula togata 322  
facsimile 163  
Fagus silvatica 176  
falx 63  
farina 292, 350  
fascia 231, 316  
fasciculus 274, 370  
fascis 117, 260, 287  
fasti 163  
fastigium 164  
fauces 143  
Favonius 481  
fayus 164  
fax 165, 458  
feles 165  
felinus 165  
femur 124  
fenestra 128, 150, 409, 489  
fenestra ovalis 52  
fenestra rotunda 52  
ferculum 166  
fermentum 324  
ferramentum 394  
festi dies 167  
fetialis 169  
fetus 471  
fibula 169, 285, 317, 486  
fibula anterior 317  
fibula arcuata 170  
fibula posterior 317  
fides 170  
fidicen 170  
figulus 45  
filix 171  
filia 12  
filius 11  
filum 171, 216  
filum Ariadnae 171  
filum electricum 158  
fines 262  
fiscus 171  
fistuca 275  
fistula 158, 216, 232, 233  
flabellifera 172  
flabellum 172  
flagellum 173  
flamen 173  
flamen Dialis 173

flos aconiti 3  
fluuius 380  
foculus 174  
focus 174, 155  
folium 175, 2, 257  
follis 177  
fons 178, 380  
foramen 21, 325, 367  
forceps 179  
forfex 179, 450  
forfices 329  
forma 180  
forma Urbis 357  
formica 181  
fornaculum 182  
fornax 181  
fornicari 182  
fornix 182, 326  
Fortuna 182  
forum 185  
Forum Romanum 183  
fossa 87, 261  
fovea 187  
Fraxinus excelsior 177  
frenare 187  
frenum 187  
fretum 188  
fretum Gaditanum 188  
fretum Siculum 188  
frigidarium 188, 226  
fritillus 189  
frons, ndis 84  
frons, ntis 123, 315  
frontispicium 189  
frumentum 128, 291  
frustulum 284  
fruticetum 311  
fucus 190  
fucus apis 25  
fulcrum 457  
fulgur 434  
fullo 191, 43  
fullonica 191  
fullonium 191  
fulmentum 308  
funale 191  
funalis 192, 240  
funambulus 192  
funda 192, 285, 481  
funda librilis 193  
funditor 193, 285  
funebria 194  
funebris 194  
funis 19, 317, 437  
funus 193  
furca 194, 84  
Furcae Caudinae 76  
furnus 194  
fuscina 379, 455  
fusor 310  
fusus 195, 111, 329

G  
Gades 188  
galea 197, 285  
galea cristata 128, 197  
Gallia Romana 197  
Ganymedes 461  
Gemini 497  
gemini 269  
gemma 199  
gena 123  
gener 12  
gens 200  
gentilis 200  
genu 124  
geometra 277  
geometria 199  
Germania 207  
gesticulator 288  
gestus adorandi 7  
gestus precandi 359  
Gigantes 492  
girgillus 368  
glacies 434  
gladiator 99  
gladius 268  
globus 329  
glomus lanae 448  
glos 11  
gluma 413  
gluten 207  
glutinator 207  
glutinum 207  
gnomon 468  
Gorgo 9  
graduale 207  
gradus 31, 189, 207, 281, 289,  
444, 491  
gradus affinitatis 11  
gradus cognationis 108  
Graecia 209  
grammatica 79, 460  
grando 434  
granum 413  
graphium 209  
gravitas 354  
gremium 210  
groma 278  
gryphus 211  
gryps 211  
gubernaculum 26, 39, 211, 376  
gubernator 211, 365  
gurgis 211  
gustare 399  
gustus 399  
gutta 213, 434  
guttur 316  
gutturales 316  
gyrus 214

H  
habena 215, 187

hamus 215, 216  
harena 17  
harpago 215  
harundinetum 311  
harundo 216  
haruspex 216  
hasta 240, 285  
haurire 406  
hebdomas 217  
Hecate 217  
Hecate triformis 217  
hedera 217, 364  
helciarum 218  
helcium 218  
heliotropium 219  
Helle 342  
Hellespontus 342  
Helvetia Romana 219  
hepar 399  
heros 28  
Hesperides 221  
hic 264  
hiems 223  
hinc 264  
Hippocampus 222  
Hispania Romana 221  
histrion 338  
holus 490  
Horae 233, 143  
horologium 223  
horreum 224  
hortator 224  
hortator remigum 224  
hortolanus 300  
hortus 225, 152, 247  
hortus deliciarum 42  
hortus Hesperidum 221  
hostia 215, 31  
hostiae infula 231  
huc 264  
hyperbola 398  
hypocaustum 226, 182

I  
ianitor 333  
ianua 101  
Ianus 227  
Ianus biceps 227  
Ianus bifrons 227  
Iason 342  
ibi 264  
ichnographia 235  
iecur 227  
illitteratus 62  
imaginarius 228  
imaginari 228  
imaginifer 228  
imago 228  
imago acu picta 343  
imago clipeata 104, 460

imber 216, 434  
imbrex 433  
imitari 288  
impedimenta 229  
imperator 13  
impluvium 149, 151, 247  
impressio 468  
impressor 495  
in antis 435  
in antis duplex 435  
incidere 72  
incipit 370  
incisio 72  
incunabula 229  
incus 230  
inde 264  
index 231  
index ciborum 231  
index voluminis 231  
infans 11  
infantia 155  
inferi 85  
infula 231  
infula sacerdotis 231  
infundibulum 232, 425  
initialis 232  
initiatio 289  
Ino 342  
inscriptio 449  
insectum 296  
insigne 232  
insigne navis 232  
institor 91, 281, 449  
instrumenta musica 233  
instrumenta scribendi 236  
insula 235, 319  
insulae Vulcaniae 492  
interlunium 267  
intervallum 237  
intestina 124  
introrsum 372  
inventor 337  
investigare 485  
Iovis dies 217  
irasci 399  
iris 310, 434  
irretire 378  
irrigare 77  
istic 264  
istinc 264  
istuc 264  
Italia 237  
iungere 239  
iugalis 240  
iugulum 123  
iugum 239, 79, 259  
iugum textorium 240, 354  
iuncus 396  
Iuno Sospita 52  
ius imaginum 228  
ius talionis 431

iuvenis 11  
iuventus 155  
  
K  
Kalendae 73  
kymation 190  
  
L  
labarum 241  
labiales 316  
labium 123, 315  
labrum 241  
labyrinthus 242  
lacerta 243  
lacertus 317  
Lachesis 329  
laconicum 55  
lactare 156, 269  
lactere 269  
lacunar 246  
lacus 349, 380  
laena 173  
lagoena 425  
lamina 402  
lana 243  
lanarius 243  
lanx 244, 259, 419  
Laocoon 245  
lapticida 46  
lapticidina 246  
lapidarius 245  
lapis 276, 471  
laquear 246  
laqueus 248  
Lares 8, 69, 483  
laridum 249  
larva 339  
later 250  
laterculus 250  
laterna 249  
latifundium 251  
latitudo 372  
Latium 251  
laurus 315, 479  
lectica 251  
lecticarius 251  
lectisternium 253  
lectulus 251  
lectus 253, 95, 394  
legenda 253  
legenda Aurea 254  
legumen 340  
lens biconcava 308  
lens biconvexa 308  
lens concava convexa 308  
lens convexa concava 308  
lens plana concava 308  
lens plana convexa 308  
lentes 490  
lentes convergentes 308  
lentes divergentes 308

Leo 497  
leporarium 255  
lepus 255  
levir 11  
libella 256  
liber 257  
libra 259, 419, 448  
Libra 412, 498  
librarius 257  
libri Sibyllini 403  
Liburna 259  
Liburnica 259  
Liburni 259  
lictor 260, 13  
ligare 123  
lignum 276  
ligo 261  
ligula 106  
lima 261  
limare 261  
limen 261  
limes 262  
limes Germaniae Superioris 262  
limes Rhaeticus 262  
linea 199, 216  
linea conchalis 201  
linea curva 199  
linea inclinata 203  
linea flexuosa 201  
linea ovalis 202  
lineae parallelae 204  
linea perpendicularis 202  
linea recta 199  
linea vere ovalis 202  
lingua 315, 399  
linter 263  
litteratus 62  
litus 263, 319  
lituus 263, 51  
loculamentum 468  
locus 264  
longitudo 372  
lorica 9, 286, 416  
lucerna 265  
lucerna fictilis 177  
lucerna pensilis 265  
Lucifer 53  
lucus 266  
ludere utro uncto 474  
ludus 266  
ludus talorum 431  
ludus Troianus 461  
luna 267  
luna crescens 267  
luna decrescens 268  
Lunae dies 217  
lupa 269  
lupa Capitolina 269  
lupus 159  
lustratio 424  
luteum 318

lycopersicum 490  
lyra 170, 233

## M

macellarius 43, 271  
macellum 271  
maceria 225  
machina elevatoria 467  
machina pictoris 342  
maeandrus 271  
magistratus curulis 228  
maiestas 273  
maiestas domini 273, 467  
malleus 273, 72, 385  
malus 39, 120  
mane 378  
manica 274  
manipulus 274  
mansuetarius 274  
mantele 385  
manubrium 103  
manu emittere 275  
manumissio 275  
manus 123  
manus ferrea 215  
mappa 275, 385  
mappa mundi 276  
Mare Nostrum 188  
margarita 199  
margo ferreus 468  
maritus 11  
Mars 492  
marsupium 420  
Martis dies 217  
mas 181  
massa 16, 324  
Massicus 75  
mater 108  
materia 276  
matertera 108  
matrimonium 306  
matutinus 378  
Mauretania 188  
Mausoleum 277  
Mausoleum Hadriani 277  
Mausolus 277  
maxilla 317  
meatus acusticus 51  
Medea 342  
medius digitus 123  
medulla 317  
mel 25  
Melpomene 295  
membrana 397  
membrana cornea 310  
membrana reticulata 309  
membrana sclerotica 309  
membrana tympani 51  
meminisse 399  
mensa 38  
mensis 227

mentor 277  
mensura 279  
mensura longitudinis 281  
mensurae publicae 280  
mentum 123, 315  
mercator 281  
mercatus 282  
Mercurii dies 217  
meretrix 338  
meridianus 378  
meridies 378  
merx 282  
messis 283  
messor 283  
meta 283  
meta destillatoria 283  
metiri 277  
mica 284  
micare 284  
microscopium 308  
miles Romanus 285  
milia passuum 281, 288  
miliarium 288  
miliarium aureum 288  
mimus 288  
Minerva 38  
miniatura 290  
minio 289  
minium 232  
minister 118  
Minotaurus 242  
Mithra 289  
Mithraeum 289  
modiolus 24, 85, 129, 373, 381  
modus 280  
moenia 353, 364  
moenia Serviana 401  
Moesia 323  
mola 291  
mola aquaria 291  
moles caeli 50  
molinarium 43, 291  
monasterium 108  
Moneta 291  
monetarii 291  
monile 293  
monochordum 79  
monogramma Christi 401  
monoxylos 263  
mons 426  
mons ignivomus 493  
monumentum Ancyranum 293  
monumentum funebre 279  
mortarium 294, 425, 474, 490  
mortuus 162  
mulctra 294  
mulctrum 294  
mulgere 294  
mulier 12  
munitio 262  
murex 295, 368

murex ferreus 295  
murtetum 311  
murus 490  
mus 159, 296  
mus alatus 483  
Musae 295  
musca 296  
muscarium 296  
muscipula 296  
muscus 297  
muscus hepatica 297  
musica 79  
mustum 134  
mysta 290

## N

nares 123, 399, 486  
nassa 299  
nassiterna 300  
nasus 123, 315  
naumachia 299  
navis 301  
navis actuaria 302  
navis longa 301  
navis oneraria 302  
navis tecta 301  
navis turrita 302  
nebula 434  
nectere 169  
nepos 107  
neptis 107  
Neptunus 459  
nere 195  
Nereides 222, 460  
nervus 233  
nervus acusticus 52  
nervus opticus 309  
nimbus 302  
nix 434  
noctua 304  
nocturnus 143, 378  
nomenclator 304  
nomenclatura 304  
nomen gentile 200  
Noricum 375  
norma 304, 79  
nota 305  
notae Tironiae 305  
notarius 305  
novacula 449  
nova luna 267  
noverca 11  
nox 143, 378  
nubere 306  
nubes 434  
nucamentum 348  
nucleus 50, 311, 487  
nummus 112  
nundinae 306  
nundinari 306  
nuptiae 306

nurus 11  
nux 489

O

obeliscus 307  
obliquitas 337  
oblongum 206  
occa 307  
occare 307, 391  
occasus 378  
occatio 376  
occidens 378  
occidentalis 378  
Oceanus 314  
Oceanus Atlanticus 188  
ocularia 307  
ocularium 308  
oculus 309, 39, 123, 399  
octangulus 309  
octogonum 309  
officina 310  
officium 310  
olfacere 399  
olfactus 399  
oleum 311  
oliva 311  
olivetum 311  
olla 132  
operculum 468  
opifera 39  
opifex 432  
oppugnator 333  
opus 312  
opus albarium 432  
opus Alexandrinum 312  
opus arcuatum 29  
opus arenatum 432  
opus caelatum 390  
opus incertum 312  
opus marmoratum 432  
opus reticulatum 312  
opus spicatum 312  
opus tessellatum 312, 439  
opus testaceum 432  
oraculum 313  
orans 7  
orbiculus 313  
orbis 97, 381  
orbis terrarum 314  
orchestra 443  
ordiri 442  
ordo velleris aurei 479  
Orestes 315  
organum 233  
organum hydraulicum 233  
oriens 378  
orientalis 378  
origo 179  
ornatrix 316  
orthographia 235  
ortus 378

os, oris 315, 123  
os, ossis 317  
os sessibuli 317  
oscillatio 317  
oscillum 318  
ostium 102  
ovis 424  
ovum 318

P

pabulum 358  
paeninsula 319  
paganus 200, 320  
pagina 468  
pagus 319  
pala 320  
palaestra 267  
palatales 316  
palatium 320  
palatum 315, 399  
palea 478  
palimpsestus 321  
palla 486  
pallium 321  
palma 7, 123  
palpebra 123, 310  
paludamentum 322  
palus 322  
panem et circenses 98  
panificium 324  
panificus 324  
panis 323  
Pannonia 323  
pannus 180, 441  
Pantheon Romanum 325  
papilio 327  
papyrus 328  
parabola 398  
Parcae 329  
paries 329  
paries craticius 330  
paries latericius 330  
pars pro toto 83  
passus 281  
patagium 330  
patella 479  
patena 331  
pater 107  
patera 331  
patina 331  
patruelis 107  
patruus 107  
pavimentum 331  
pavimentum stratum 487  
pavo 332  
pecten 332, 240  
pectus 123  
pecunia 112  
pedes 39  
pedicae 274  
pediludium 333

Pegasus 61, 96  
pelvis 385  
Penates 483  
penicillus 272, 342, 474  
peniculus 342  
penna 335, 130  
pensum 111, 244  
pentagramma 363  
percontari 117  
pergula 336  
periphēria 200  
peripteros 436  
peristylum 149, 150  
perna 249  
perpendicularum 337, 256  
persicum 489  
persona 337  
personatus 339  
perspectiva 392  
perspicilla specularia 307  
pertica 91, 311  
pes 124, 281  
pharetra 36  
pharmacopola 339  
pharmacopolium 339  
pharus 340  
phaselus 340  
phases lunae 267  
Phoebus 26  
Phoenix 341  
phorminx 234  
Phosphorus 53  
Phrixus et Helle 342  
pictor 342  
pictura 343  
pictura in linteo 343  
pictura in sipario 343  
pictura in tabula 343  
pictura inusta 343  
pictura textilis 343  
pictura udo tectorio picta 343  
picus 344  
pila 344  
pilae 468  
pila 345  
pila electrica 345  
pilare 490  
pilarius 346  
pilastrum 23  
pileolus 347  
pileus 347, 173  
pinetum 311  
pingere 343  
pinna 347  
pinna gubernaculi 348  
pinnae moenium 347  
pinus 348  
piscator 348, 216  
piscatorius 348  
Pisces 498  
piscina 349

piscis 416  
pistillum 350, 294, 360  
pistor 350, 43  
pistrina 350  
pisum 490  
pittacium 351  
plaga 378  
planta 124  
plaustrum 351, 67, 467  
plectrum 170  
plenilunium 268  
pluma 347  
pluteus 352, 208, 257  
pluvia 434  
pocillator 118  
poculum 75, 96, 118  
pollex 123  
polus 54  
Polyhymnia 296  
polypus 53  
polyspaston 314  
pomarium 352  
pomarius 352  
pomerium 353  
pometum 311, 352  
pompa 166, 438  
pondus 354, 240, 419  
pons 353  
pons Cestius 353  
pons sublicius 354, 422  
pontifex 163  
porta 355, 489  
porta praetoria 88  
porta versatilis 105  
porticus 356, 327  
porticus Liviae 357  
portitor 95  
portus 357  
positio 264  
postdiluvianus 144  
posticum 150  
postmeridianus 378  
post meridiem 378  
praecinctio 57  
praeco 358  
praefericulum 385  
praefurnium 181  
praesaepe 358  
praesaepium 358  
precatio 359  
prelum 359, 468  
prelum hydraulicum 360  
premere 359  
pressorium 359  
principium 179  
privigna 12  
privignus 12  
profunditas 372  
progenies 362  
proiectio 360  
proles 361

proletarius 361  
prologus 361  
promontorium 319  
prooemium 361  
propaganda 362  
propagare 362  
propago 362  
proportio 362  
proportio divina 362  
proportionalitas 363  
propugnaculum 364  
prora 365, 39, 381  
proreta 365, 118  
proreus 365  
prorsum 372  
Proserpina 457  
prostylos 435  
prototypus 163  
pruina 434  
pruna 365  
prunum 489  
prunus 489  
puella 12  
puer 11  
pugillares 107  
pugna navalis 299  
pullus 318  
pulmo 124  
pulpitum 381  
pulvinar 95, 253, 366  
pulvinus 366, 251  
pupa 367  
pupilla 310, 367  
puppis 367, 26, 39, 365  
pupula 310  
purpura 367, 295  
purpuratus 368  
putamen 318  
puteal 368, 439  
puteus 368  
pyrobolum vi atomica  
... explosens 50  
Pythia 313  
pyxis 368

Q  
quadra prima 268  
quadra ultima 268  
quadrangulum 205  
quadrans 88  
quadratum 204  
quadriga 369, 192  
quadrigae 369  
quadrigatus 369  
quadriremis 393  
quadrivium 370, 41  
quadrupes 165  
quantitas 280  
quaternio 370  
quercetum 311  
Quercus robur 175

quo 262  
quoversum 371  
quorsum 371

R  
radicitus 374  
radius 373, 206, 381, 441  
radix 373, 362  
raeda 374  
Raetia 375  
ramale 84  
rana 375  
raster 376  
rastrum 376  
ratis 376  
receptaculum 33  
rectitudo 337  
regina apium 25  
regio 377  
regio Basiliensis 377  
regiones caeli 378, 377  
regula 200  
remus 39, 365  
repagulum 101  
repositorium 132  
restis 243  
rete 378  
rete araneae 379  
retiarius 379  
reticulum 379, 486  
retinaculum 468  
retrorsum 372  
rhetorica 460  
rhomboides 205  
rhombus 205  
ripa 379  
rivalis 379  
rivus 379  
rogus 380  
rosa 490  
rosa canina 364  
rostra 380  
rostrum 381, 39, 365  
rostrum navale 381  
rota 381, 33  
rota aquaria 382  
rota Fortunae 382  
rota tractoria 382  
rotula saltans 266  
rotulus 383  
rudicula 383  
rudis 383  
rudus 487  
runcina 305, 447  
rursum 372

S  
sacerdos 385  
sacrificium 385, 85  
sacrum Apollinis 141  
saepes 385

saepia 385  
 saeptum 92, 385  
 sagitta 36, 89, 134  
 Sagittarius 35, 498  
 sagum 286, 322  
 Salacia 459  
 salmo 387  
 sal nitratum 346  
 saltatio 84  
 saltus ad funem 266  
salus 387  
 salutare 387  
 sapere 399  
sarcina 389  
 sarcinae exercitus 229  
 sarcinae 389  
sarcophagus 389  
sarculum 391  
 sarire 391  
sartago 391, 131  
 satio 424  
Saturnalia 392  
 Saturni dies 217  
 satyrus 474  
 scabellum 394  
 scaena 444  
scaenographia 392  
scala 393  
 scala cochleata 106  
 scala tympani 52  
 scala vestibuli 52  
 scalpellum 335, 394  
scalprum 394, 447  
scamnum 394, 257  
scapha 395  
 scapha complicabilis 395  
 scapula 315  
 scapus 21, 345, 419  
scarabaeus 395  
sceptrum 395  
 schedula 351  
 schola 267  
 scipio 117  
scirpea 396  
 scirpus 396  
 scobes 346  
scopa 396  
 scopae 396  
 Scorpio 498  
 scriba 243  
 scrinium 316, 474  
 scriptorium 258, 335  
 sculptor 45, 390  
 scutica 462  
 scutum 9, 104, 285  
scytala 397  
 secans 205  
 secespita 385  
 sectio 28  
 sectio aurea 362  
sectio conica 398

sector 206  
securis 398, 260, 287, 385  
 sedile 491  
 segmentum maius 205  
 segmentum minus 205  
 segmenta similia 206  
 sella 342  
sella curulis 136, 117  
 sella equestris 157  
 semicirculus 205  
 semita 126  
 senex 338  
sensus 399  
 sentire 399  
 septem mirabilia mundi 277  
 septentrio 378  
 Septentrio 481  
 septentrionalis 378  
septentriones 399  
 septimana 217  
Septimontium 400  
sepulcrum 401  
sera 402  
 serpens alatus 458  
 serra 402, 447  
 seta 244  
Sibylla 402  
 sidus 38  
 sigillare 405, 439  
 sigillum 405  
signifer 404, 13, 286  
signum 405, 13, 286  
silex 405  
silicernium 406  
 silva 426  
simpulum 406, 385  
 simulacrum 338, 342  
 sinistrorsum 372  
sinus 407, 319  
 siparium 343  
 siphon 242, 477  
 siphunculus 225  
 Sirenae 407  
Sirenes 407  
 sirpea 396  
sistrum 408, 233  
 sitella 408  
situla 408, 425  
 soccus 112  
 socer 11, 12  
 socrus 11, 12  
 sol 411  
solarium 409, 224, 490  
solea 410, 486  
 soleae oblongae 410  
solium 411  
solstitium 411  
 solstitium aestivum 411  
 solstitium hibernum 411  
 Solis dies 217  
 sors 408

spatha 448  
 spatium 237  
 specillum 307  
 spectator 444  
 specula 262  
speculum 413, 486  
 spelunca 426  
sphaeristerium 413  
spica 413  
 spicarium 490  
 spiculum 130  
spina 414  
 spina dorsi 317  
 spina navis 365  
 spira 169  
 spolium 462  
sponda 415  
 spondere 415  
spongia 415  
 sponsa 415  
 sponsalia 356, 415  
sponsus 415  
sporta 416  
 sportella 416  
 sportula 416  
 spuma 434  
squama 416  
 squamatus 416  
stabulum 417  
 stagnum 349  
 stamen 240  
 stapes 51  
statera 419, 21  
 stativa 18  
statua 419, 180  
 statumen 487  
 stella polaris 399  
 stereoscopium 308  
 stigma 305  
stillicidium 420, 433  
 stilus 236, 257  
 stiva 32  
 stola 486  
 stramentum 84  
strenae 420  
strigilis 420, 415  
structor 421  
 structura 35  
 Styx 95  
 suber 126  
sublica 421  
 subtemen 240  
 suburbanus 423  
suburbium 423  
 sucula 468  
 sudatio 55  
 suere 427  
sufflamen 423  
 suggestus 14, 114  
 suggestus 381  
sulcus 424

suovetaurilia 424  
supellex 425  
supercilium 123  
superficies 426  
supplex 426  
supplicatio 426  
sura 124  
surculus 397  
sursum 372  
sus 424  
sutor 427, 45  
sutrina 427  
symbolum 427  
symbolus 427  
systema mundi 428

## T

taberna 429, 247  
taberna macellaria 271  
tabernaculum 430  
tablinum 149, 247  
tabula 429, 236  
tabula lusoria 1  
Tabula Peutingeriana 429  
tabulatum 464  
tachygraphia 305  
tactus 399  
taeda 429  
talaria 430, 71  
talio 431  
talpa 431  
talus 431, 189  
tangens 205  
taurus 424  
Taurus 497  
tector 432  
tectorium 432  
tegula 433, 489  
tela 180, 240, 441  
tela araneae 379  
telamones 50  
Tellus 433  
temo 434, 33  
tempestas 434  
templum 435, 52  
tempus 227, 378  
tempus futurum 227  
tempus praeteritum 227  
tensa 437  
tensor stapedii 52  
tensor tympani 51  
tentorium 437  
tentorium militare 328  
tepidarium 55, 226  
terebra 439  
terebrare 439  
tergum 123  
terminus 353  
Terpsichore 295  
terra 139, 155  
terra cocta 440

terra sigillata 439  
tessera 439  
tessera congiarii 114  
tessera frumentaria 440  
tessera hospitalis 440  
tessera lusoria 440  
testa 440  
testudo 441  
texere 441  
textor 441, 43  
textrix 441  
textum 441  
textus 442  
Thalia 295  
theatrum 443  
thermae 56, 188  
Thermae Diocletiani 188  
thermopolium 445  
thesaurus 445  
tholus 435  
Thracia 323  
thus 463  
thyrsus 446  
tiara 446  
tiaras 446  
tibia 124, 233, 317, 446  
tibicen 446  
tibicina 446  
tignarius 447, 45  
tignum 247  
tinctor 448  
tinctorium 448  
tinctura 448  
tinnitus 448  
tintinnabulum 448  
Tiro 305  
titulus 449  
titulus sepulcralis 401  
toga 486  
toga praetexta 69, 116  
tolleno 449  
tomaculum 92  
tonitru 434  
tonsor 449  
tonstrina 449  
toral 450  
torcular 451  
torculum 451  
torques 451  
torus 452, 450  
torus columnae 453  
trabes 449  
tragoedia 126, 337  
traha 453  
trahea 453  
transenna 453  
trapezium 205  
triangulum 205  
triangulum acutangulum 206  
triangulum aequicrurum 205  
triangulum aequilaterum 205

triangulum obtusangulum 205  
triangulum rectangulum 206  
triangulum scalenum 206  
tribulum 454  
triclinium 455, 247  
tricuspis 455  
tridens 455  
trifidus 455  
triforium 456  
triglyphus 213  
Triptolemus 456  
tripus 457, 125, 131, 425, 479  
triremis 393  
Triton 459  
triumphus 459  
trivium 460, 41  
trochlea 468  
trochus 461  
troia 461  
tropaeum 462  
tropicus circulus Cancrī 498  
tropicus circulus Capricornī 498  
trua 462  
truia 461  
trulla 462  
trutina 419  
tuba 233, 287, 424, 459  
tuba Eustachii 52  
tubulus 308  
tueri 465  
tundere 273  
tunica 285, 486  
turbo 462  
turibulum 463  
turris 464, 262  
turris ventorum 223  
turritus 464  
tus 424, 463  
tutela 465  
tutelares dei 465  
tympanistria 466  
tympanum 466, 164, 233  
tympanum dentatum 292  
typographia 468  
typographus 468  
typotheta 468  
typus 469  
typus aeneus 468

## U

ubi 264  
Ulmus campestris 175  
umbilicus 471, 383  
umbo 471  
umbra 336  
umbraculum 472, 368  
umbrella 422  
umerus 124  
umor vitreus 310  
uncus 215  
unde 264



unguentarius 472  
unguentum 472  
Urania 296  
urceatim 473  
urceus 473, 425  
urna 473  
Ursa 399  
utensilia 473  
utensilia culinae 131  
uter 474  
uterus 471  
utopia 475  
utrarius 474  
utricularius 476  
uva 452  
uxor 12

## V

vacuum 477  
vadum 477  
vagina 478, 413  
vallis 426  
Vallis Poenina 219, 375  
vallum 87, 88, 261, 364, 490  
valvae 478  
vannus 478  
vapor 434  
vaporarium 226  
vas 415  
vas diatretum 142  
vas unguentarium 472  
vates 479  
vaticinatio 479  
vaticinium 315, 479  
vaticinor 479  
vehi 156  
vehiculum 437  
velares 316  
vellus aureum 479  
velum 480, 39, 316, 486  
vena 124  
venatio 480  
venator 480  
Veneris dies 217  
venter 124  
ventus 481  
ventus adversus 481  
ventus secundus 367, 481  
Venus 135, 492  
ver 223  
versus 468  
vertebra 317, 414  
vertex 482, 123  
veru 482  
vesper 378  
vespertilio 483  
vespertinus 378  
Vesta 483  
Vestalis 484  
vestiarium 485  
vestiarius 485

vestibulum 485, 149, 247  
vestigium 485  
vestimenta militum 285  
vestimenta mulierum 486  
vestimenta Romana 486  
vestimenta virorum 486  
vestis triumphalis 459  
vetula 12  
vexillum 487, 13, 287, 424  
via 487  
via Appia 488  
via brevior 113  
via praetoria 88  
via principalis 88  
via strata 488  
viator 488  
victima 216  
Victoria 191  
vicus 87, 281  
videre 399  
vigiles 489  
vigiliae 143, 489  
villa rustica 489  
vimen 299  
vinarius 46  
vindemia 296, 452, 489  
vindicta 275  
Vindonissa 87  
vinea 451  
vinetum 311  
vinitor 452  
vinum 489  
vir 11  
virga 260  
virgo 12  
Virgo 497  
virgo Vestalis 484  
vis atomica 50  
visus 399  
vitellus 318  
vitis 452  
vitra ocularia 308  
vitricus 11  
vitta 491  
volsella 491  
volumen 207, 258  
volumen epistulae 236  
vomere 32, 424  
vomitorium 491, 133  
vortex 482  
votum 153, 485  
Vulcanus 492  
vulnus 493  
vulpes 272

## X

xylographia 495

## Z

zincum 346  
zodiacus 497

zona 497  
zona nivalis 498  
zona temperata 498  
zona torrida 498

## index locorum

- A**  
Ammianus 15, 7, 6: 442  
Ambrosius 3 de Dav. 11, n. 89: 469  
Anthol. Latina 65, 3 M.: 408  
Arnobius 3, 41: 483  
Augustinus, Civ. D. 10.5: 385
- B**  
Bellum Alex. 1: 117  
Bocacius De claris mulieribus: 403  
Buchananus in Psalm. XVIII: 144
- C**  
Caelius Aurelius, Tard. 1, 4: 284  
Caesar, B. G. 1, 6, 2: 477  
— 1, 25: 493  
— 1, 26: 230  
— 4, 25: 193  
— 5, 19: 159  
— 6, 17: 281  
— 7, 36: 374  
— 7, 69: 164  
— 7, 72: 347  
— 8, 43: 134  
— 8, 51: 225  
Caesar, B. C. 1, 28, 4: 393  
— 1, 57: 215  
— 2, 10: 77  
— 3, 76: 389  
Calpurnius, Ecl. 4, 25: 294  
Capitol. Maxim. 19, 4: 153  
Cassiodorus, de geom. 6: 363  
Cassiodorus, Hist. Eccl. 10, 4: 16  
Cato, r. r. 1, 2: 73  
— 18, 7: 332  
— 74: 294  
— 79: 383  
Catullus 3, 1: 135  
— 4, 2: 341  
— 13, 7/8: 32  
— 71, 4: 263  
Cicero, Acad. post. 1, 2, 8: 179  
— 2, 81: 431  
— 2, 94: 13  
— ad Att. 5, 20, 3: 147  
— 6, 1, 12: 73  
— 6, 1, 25: 374  
— 6, 2, 6: 5  
— 15, 14, 4: 289  
— ad fam. 1, 7, 1: 237  
— 7, 18: 321  
— de inv. 2, 4, 14: 282, 478  
— de orat. 1, 6, 23: 229  
— 2, 83, 338: 446  
— 3, 9, 36: 72  
— 3, 15, 58: 266  
— de re publ. 3, 9, 16: 311  
— 6, 18: 428  
— 34, 53: 10  
divin. 1, 45, 101: 293  
— 1, 57: 67  
— 2, 6, 17: 140, 283  
— 2, 41, 85: 284  
— 2, 41, 86: 211  
— in Pis. 3, 7: 381  
— 27, 67: 134  
— leg. agr. 2, 33, 89: 224  
— nat. deor. 1, 10, 24: 377  
— 1, 20, 52: 54  
— 1, 20, 54: 230  
— 1, 35, 99: 227  
— 1, 43, 121: 374  
— 2, 2, 6: 85  
— 2, 27, 67: 176  
— 2, 48, 123: 378  
— 2, 63, 158: 486  
— 3, 34, 84: 358  
— 3, 39, 92: 276  
— prov. cons. 11, 27: 427  
— off. 1, 13, 39: 111  
— 1, 44, 157: 164  
— 71, 235: 397  
— Quinct. 13, 45: 338  
— senect. 6, 17: 211  
— 13, 45: 118  
— Tusc. 1, 18, 41: 237  
— 1, 25, 62: 305  
— 5, 23, 64: 373  
— Verr. 2, 4, 39: 293  
— 3, 23, 9: 211  
— 4, 1, 1: 343  
— 4, 14, 32: 439  
— 4, 17, 37: 248  
— 4, 25, 56: 52  
— 4, 48, 106: 471  
— 4, 53, 118: 178  
— 5, 30, 77: 135  
Columella r. r. 2, 20, 4: 478  
— 4, 20, 5: 199  
— 4, 25, 1: 407  
— 5, 11, 4: 276  
— 7, 8, 7: 180  
— 7, 9, 12: 305  
— 8, 17, 6: 78  
— 9, 5, 3: 15  
— 11, 2, 31: 412  
— 12 praef. 3: 473  
— 12, 57, 1: 294  
Comenius Orbis pictus 7: 434  
— 8: 426  
— 36: 11  
— 93: 468  
Curtius 8, 9, 23: 463  
— 8, 13, 23: 377
- E**  
Erasmus Adag. 4081: 159  
Evang. sec. Matth. 2, 11: 463
- F**  
Florus, epit. 1, 19, 3: 125
- G**  
Gellus 1, 19, 11: 403  
— 5, 6: 122  
Guido Aretinus: 238
- H**  
Hieronymus ep. 54, 13: 413  
— 140 n. 8, 2: 490  
Historia Augusta 17, 21: 274  
Horatius A. P. 80: 112  
— 304 s.: 125  
— 412: 283  
— carm. 1, 4, 13 s.: 429  
— 1, 28, 1 s.: 277  
— 2, 7, 22 s.: 96  
— 3, 24, 9: 351  
— 4, 3, 23: 170  
— c. s. 61 s.: 26  
— ep. 1, 2, 69 s.: 440  
— 1, 5, 22 s.: 450  
— 1, 10, 24: 194  
— 1, 10, 36: 187  
— 1, 14, 2: 176  
— 1, 16, 50: 187  
— 1, 18, 15: 243  
— 1, 18, 84: 330  
— sat. 1, 3, 37: 171  
— 1, 5, 14 s.: 375
- I**  
Isidorus orig. 15, 4, 6: 108  
— 15, 4, 7: 435  
— 15, 5: 356  
— 18, 3, 5: 274  
— 19, 22, 9: 137  
— 19, 31, 11: 451  
— 20, 16, 6: 72  
Iuvenalis 10, 81: 98  
— 15, 127: 341
- L**  
Livius 1, 18, 7: 263

- 1, 44, 4: 353
  - 5, 13, 6: 253
  - 9, 40, 3: 128
  - 9, 46, 5: 14
  - 21, 18, 13: 407
  - 21, 26, 8: 263
  - 22, 10, 9: 253
  - 25, 2, 8: 114
  - 29, 14, 13: 463
  - 30, 10, 14: 116
  - 30, 10, 16: 216
  - 40, 51, 4: 345
  - 41, 27, 7: 405
  - Lucanus 1, 237: 264
  - Lucretius 1, 739: 458
  - 5, 966 s.: 101
- M**
- Macrobius sat. 1, 16, 34: 306
  - 6, 4, 4: 491
  - somn. 2, 2, 4 ss.: 426
  - Manilius 1, 679: 57
  - 4, 197 ss.: 305
  - Martialis 1, 117, 7: 393
  - 3, 82, 15: 127
  - 7, 61, 1 ss.: 449
  - 9, 18, 3 s.: 24
  - 10, 37, 17: 416
  - Martianus Capella 9, 314: 127
- N**
- Nepos, Att. 13, 3: 45
  - 14, 3: 423
  - Paus. 2, 3: 306
- O**
- Ovidius, amor. 2, 6, 45: 111
  - ars am. 1, 419 s.: 282
  - 3, 562: 385
  - 3, 591: 248
  - fasti 1, 47: 163
  - 1, 117 s.: 227
  - 3, 36: 284
  - 4, 649: 398
  - halieut. 18 ss.: 386
  - heroid. 16, 263: 283
  - 18, 13: 215
  - met. 1, 136: 277
  - 1, 147: 3
  - 1, 291 s.: 144
  - 2, 4: 478
  - 2, 107 s.: 434
  - 4, 34: 243
  - 6, 22: 195
  - 6, 79: 9
  - 8, 191 s.: 54
  - 8, 247 ss.: 97
  - 8, 283 ss.: 25
  - 8, 617: 71
  - 10, 125: 80
  - Pont. 4, 10, 5: 213
- trist. 1, 9, 9: 224
  - 5, 7, 49: 66
- P**
- Paulus, ad Cor. 1, 13, 12: 413
  - Paulus Festus p. 78 M.: 160
  - p. 113, 1 M.: 231
  - p. 207, 4 M.: 347
  - p. 272, 8 M.: 376
  - 302, 4 M.: 424
  - Paulus Dig. 1, 5, 1: 338
  - Petronius, sat. 27: 344
  - 29: 8
  - 34, 4: 474
  - 34, 6: 351
  - 35: 421
  - 44, 18: 473
  - 100: 115
  - Phaedrus 1, 1, 1 s.: 380
  - 1, 26 ss.: 331
  - 2, 7, 1: 389
  - 2, 7, 2: 171
  - 4, 3: 451
  - 4, 24, 17 ss.: 181
  - Plautus, Amph. 148: 250
  - 196: 53
  - 341: 493
  - Asin. 200: 324
  - Aul. 84: 32
  - Bacch. 711: 355
  - Capt. 22: 344
  - 268 s.: 332
  - 663: 391
  - 903: 249
  - Cas. 309 ss.: 194
  - 358 s.: 409
  - 476: 24
  - Curc. 203 s.: 9
  - 577: 491
  - Merc. 695 s.: 224
  - 830: 262
  - Mil. glor. 378 s.: 409
  - 504: 433
  - Most. 41: 472
  - 275: 190
  - Pers. 26 s.: 134
  - 471: 113
  - Poen. 342: 282
  - 1353 s.: 55
  - Pseud. 55 ss.: 428
  - Rud. 545 s.: 55
  - 937: 3
  - Trin. 870: 465
  - 1013 s.: 445
  - 1100 s.: 445
  - Plinius H. N. 2, 211: 390
  - 7, 10: 212
  - 7, 198: 256, 280
  - 8, 104: 431
  - 8, 133: 159
  - 10, 156: 128
- 11, 11: 25
  - 11, 188: 310
  - 13, 71: 328
  - 16, 52: 429
  - 16, 127: 374
  - 18, 35: 251
  - 18, 107: 350
  - 18, 180: 376
  - 27, 78 s.: 171
  - 33, 70: 199
  - 34, 145: 125
  - 34, 176: 383
  - 35, 89: 174
  - 35, 153: 180
  - 36, 172: 337
  - 36, 173: 110
  - Plinius Valer. 2, 17: 359
  - Porphyrio in Hor. Carm. 1, 9, 21: 267
  - 2, 7, 22: 96
  - Ps. Prosp. prom. 3, 38, 44: 190
- Q**
- Quintilianus 2, 4, 27: 157
  - 2, 21, 24: 72
  - 5, 10, 101: 248
  - 5, 11, 21: 104
  - 8, 2, 7: 482
  - 9, 2, 41: 228
- R**
- Rufinus, invect. in Hieronymum 2, 8: 370
  - Rutilius, de reditu 1, 455 s.: 365
- S**
- Schol. ad Iuvenal. 8, 159: 324
  - Seneca, Contr. 1, praef. 9: 313
  - ep. 90, 10: 84
  - 90, 23: 323
  - 90, 24: 211
  - 115, 2: 81
  - ira 2, 19: 155
  - Quaest. nat. 4 b, 13, 8: 472
  - 5, 13, 3: 462
  - Servius, ad Aen. 1, 506: 411
  - 2, 616: 302
  - 5, 114: 301
  - 6, 673: 266
  - 10, 14: 169
  - 10, 538: 231
  - 11, 788: 365
  - ad Georg. 1, 166: 479
  - Suetonius, Aug. 49, 1: 465
  - Caes. 57: 374
  - Galba 6, 1: 192
  - 6, 3: 160
  - Nero 12, 9: 368
  - 46, 4: 199

- T**  
Tacitus, hist. 2, 98: 160  
– 3, 34: 364  
Terentius, Eun. 729: 311  
– Hec. prol. 9: 361  
– Phorm. 752: 306  
Tibullus 1, 5, 70: 182  
– 1, 6, 34: 102  
– 1, 7, 55: 360  
– 2, 1, 45: 452
- V**  
Valerius Flaccus 2, 235: 429  
Varro, L. L. 5, 122: 331  
– 5, 129: 72  
– 5, 139: 396  
– 5, 153: 82  
– 6, 8: 412  
– 7, 83: 53  
– 7, 108: 402  
– r. r. 1, 1: 433  
– 1, 2, 6: 352  
– 1, 2, 27: 387  
– 1, 6, 6: 256  
– 1, 8, 5: 296  
– 1, 11, 2: 100  
– 1, 14, 4: 250  
– 1, 46: 219  
– 1, 48, 1: 413  
– 1, 54, 1: 452  
– 1, 55, 1 s.: 311  
– 3, 3, 2: 255  
– 3, 8, 1: 432  
Vegetius, mul. 1, 56, 5: 307  
Vergilius, Aen. 1, 278: 283  
– 1, 727: 191  
– 2, 2: 442, 453  
– 2, 49: 246  
– 3, 130: 367  
– 4, 239 ss.: 430  
– 5, 103: 365  
– 5, 583 ss.: 461  
– 6, 209: 66  
– 6, 302: 117  
– 6, 673: 266  
– 6, 797: 50  
– 8, 354 s.: 9  
– 10, 116: 412  
– 12, 725: 161  
– Georg. 1, 144: 133  
– 1, 166: 479  
– 1, 308: 255  
– 1, 378: 375  
– 2, 384: 474  
– 3, 297 s.: 274  
– 4, 33 ss.: 15  
– 4, 175: 179  
Vitruvius 1, 2, 2: 392  
– 1, 6, 4: 309  
– 2, 1, 3: 216  
– 3, 2, 2: 23
- 4, 1, 1: 80  
– 5, 10, 1: 226  
– 5, 11, 2: 162  
– 6, 5, 2: 129  
– 6, 8, 5: 337  
– 9 praef. 6: 304  
– 10, 2, 2: 179  
– 10, 4, 3: 85  
– 10, 5, 1: 382  
– 10, 5, 2: 291  
– 10, 8, 2: 79  
Vives, Coll. de scriptione: 335
- U**  
Ulpianus, dig. 43, 19, 1: 379

## proverbia et dicta

- ab acia et acu omnia exponere 6  
ab ovo usque ad mala 318  
acu rem tangere 6  
adhuc tua messis in herba est 283  
ad (perfectum) unguem castigare 261  
alter frenis eget, alter calcaribus 73  
ara focusque 176  
architectus architecto invidet 35  
asino clitellas imponere 104  
bovi clitellas imponere 104  
compendio ducere aliquem 113  
compendium facere 113  
concitare equum calcaribus 72  
cribro aquam ferre 128  
dignus est quicum in tenebris mices 284  
duos parietes de eadem fidelia  
  dealbare 330  
duos qui lepores insectatur, neutrum  
  capit 255  
e rivo flumen facere 379  
ex arca domoque solvere aliquid 34  
filum in acum conicere 171  
frenum mordere 187  
fuco illinere aliquid 190  
hircos mulgere 294  
homo totus de capsula 81  
horrea formicae tendunt ad inania  
  numquam 224  
in caducum parietem inclinare 330  
incudem eandem tundere 230  
inflat se tamquam rana 375  
in litus arenas fundere 263  
in portum ex alto invehi 357  
in portum se recipere 357  
in vado (salutis) esse 477  
ipse mihi asciam in crus impegi 48  
lateres coquere 250  
laterem lavare 250  
ligna in silvam gerere 263  
naturam expellas furca, tamen usque recurret 194  
navem perforat, qua ipse navigat 302  
ne sutor ultra crepidam 22  
neglectis urenda filix innascitur agris 171  
oleum et operam perdidit 311  
paene in foveam incidi 187  
panem et circenses 98  
panis sine fermento 324  
paululum a sole 148  
per transennam aspicere aliquid 454  
quiquid id est, timeo Danaos, et dona ferentes 246  
quod non fecerunt barbari, fecerunt Barberini 325  
quo semel est imbuta recens, servabit odorem  
  testa diu 440  
rixari de lana caprina 243  
rude donari 384  
sarcinis gravare 389  
scopae solutae 396  
scopas dissolvere 397  
sulcos ducere, agere 424  
sutor, ne supra crepidam 427  
struere cumulos auri 132  
vaticinium ex eventu 479  
ventis dare vela 481  
vestigia flectere ad locum 485

- Ammann W., *Baustilkunde*, Bern 1969  
 Beer J. E., *Die Rose der Kathedrale von Lausanne*, Bern 1952  
 Bilderatlas zur Kulturgeschichte I, Aarau 1968  
 Blümner H., *Technologie der Gewerbe und Künste bei Griechen und Römern*, Leipzig 1876–1887  
 Cabrol F., *Dictionnaire d'archéologie chrétienne et de liturgie*, Paris 1907–1935  
 Campbell L. A., *Mithraic Iconography and Ideology*, Leiden 1968  
 Ceccaroni A., *Vocabolario illustrato latino-italiano*, Faenza 1950  
 Comenius J. A., *Orbis Sensualium Pictus*, Nürnberg 1658 (facs)  
 Daremberg Ch. / Saglio E., *Dictionnaire des Antiquités grecques et romaines*, Paris 1877–1911  
 (delineavit P. Sellier)  
 Dictionnaire Archéologique des techniques, Paris 1934  
 Gaffiot F., *Dictionnaire illustré Latin-Français*, Paris 1934  
 Gerhard E., *Auserlesene Vasenbilder*, Berlin 1840–1858  
 Grenier A., *Manuel d'archéologie gallo-romaine*, Paris 1931 ss.  
 Grimal P., *Nous partons pour Rome*, Paris 1962  
 Gruben G., *Die Tempel der Griechen*, München 1976  
 Guhl E. / Koner W., *Das Leben der Griechen und Römer nach antiken Bildwerken dargestellt*,  
 Berlin 1862  
 Harrison J. E., *Prolegomena to the study of Greek religion*, London 1903–1911, reprint 1961  
 Harrison J. E., *Themis*, London 1963 (reprint)  
 Hind A., *An introduction to a history of woodcut*, New York 1935 (reprint 1963)  
 Irmischer J., (hg.) *Lexikon der Antike*, Leipzig 1971  
 Kähler H., *Rom und seine Welt*, München 1960  
 Kircher A., *Ars magna lucis et umbrae*, Amstelodami 1671  
 Koepf H., *Bildwörterbuch der Architektur*, Stuttgart 1968  
 Laur-Belart R., *Führer durch Augusta Raurica*, Basel 1937  
 Lavedan P., *Dictionnaire illustré de la mythologie et des antiquités grecques et romaines*, Paris 1952<sup>3</sup>  
 Linfert-Reich J., *Römisches Alltagsleben in Köln*, Köln 1977  
 Luckenbach H., *Kunst und Geschichte*, München, Berlin 1926  
 Lübkers F., *Reallexikon des klassischen Altertums für Gymnasien*, Leipzig 1891  
 Martin K., *Kunst des Abendlandes*, 1. Teil, Antike, Karlsruhe 1965  
 Mau A., *Pompeij in Leben und Kunst*, Leipzig 1908  
 Ménard R. / Sauvageot Cl., *Vie privée des anciens*, Paris s. a.  
 Mir. J., *Nova verba Latina*, Barcinone 1970  
 Mužik H. / Perschinka F., *Kunst und Leben im Altertum*, Wien/Leipzig 1909  
 Nack E. / Wägner W., *Land und Volk der alten Römer*, Wien 1956  
 Oerberg H. H., *Lingua Latina secundum naturae rationem explicata*, Copenhagen 1965<sup>3</sup>  
 Olaus Magnus, *Historia de gentibus septentrionalibus*, Romae 1555 (facs)  
 Overbeck J., *Pompeij in seinen Gebäuden, Altertümern und Kunstwerken*, 4. A. im Ver. m. A. Mau,  
 Leipzig 1884  
 Paoli U. E., *Ciceronis filius*, Bern 1961<sup>2</sup>  
 Pelletier A., *Lexique d'antiquités romaines*, Paris 1972  
 Réau L., *Dictionnaire illustré d'art et d'archéologie*, Paris 1930  
 Reisch G., *Margarita Philosophica*, Basileae 1503 (facs)  
 Rich A., *Dictionary of Roman antiquities*, London 1849  
 Roscher W. H., *Ausführliches Lexikon der griechischen und römischen Mythologie*, Leipzig 1884–1937  
 Roux G., *Delphi, Orakel und Kunststätten*, München 1971  
 Schwarz G. Th., *Die Kaiserstadt Aventicum*, Bern/München 1964  
 Voit L., *Raetia Latina*, Düsseldorf 1959  
 Von Kampen A., *Descriptiones nobilissimorum apud classicos locorum*, Series I., Gotha s. a.  
 Vox Latina, Saraviponti  
 Wägner W. / Schmidt D. E., *Rom, Geschichte des römischen Volkes und seiner Kultur*, Leipzig 1905<sup>8</sup>  
 Wegener M., *Das Musikleben der Griechen*, Berlin 1949  
 Welper E., *Elementa geometrica*, Argentorati 1620  
 Widmer S., *Illustrierte Geschichte der Schweiz*, Zürich 1965  
 Witzig H., *Das Zeichnen in den Geschichtsstunden*, Zürich 1939